



# **Sherpur Polytechnic Institute**

## **ELECTRONICS TECHNOLOGY**

# COMMUNICATION ENGINEERING

**Subject Code:  
26842**

**Prepared by:  
Nadim Al Syed Khan  
Instructor (Tech) Electronics**

# Chapter: 01

## BASIC OF COMMUNICATION

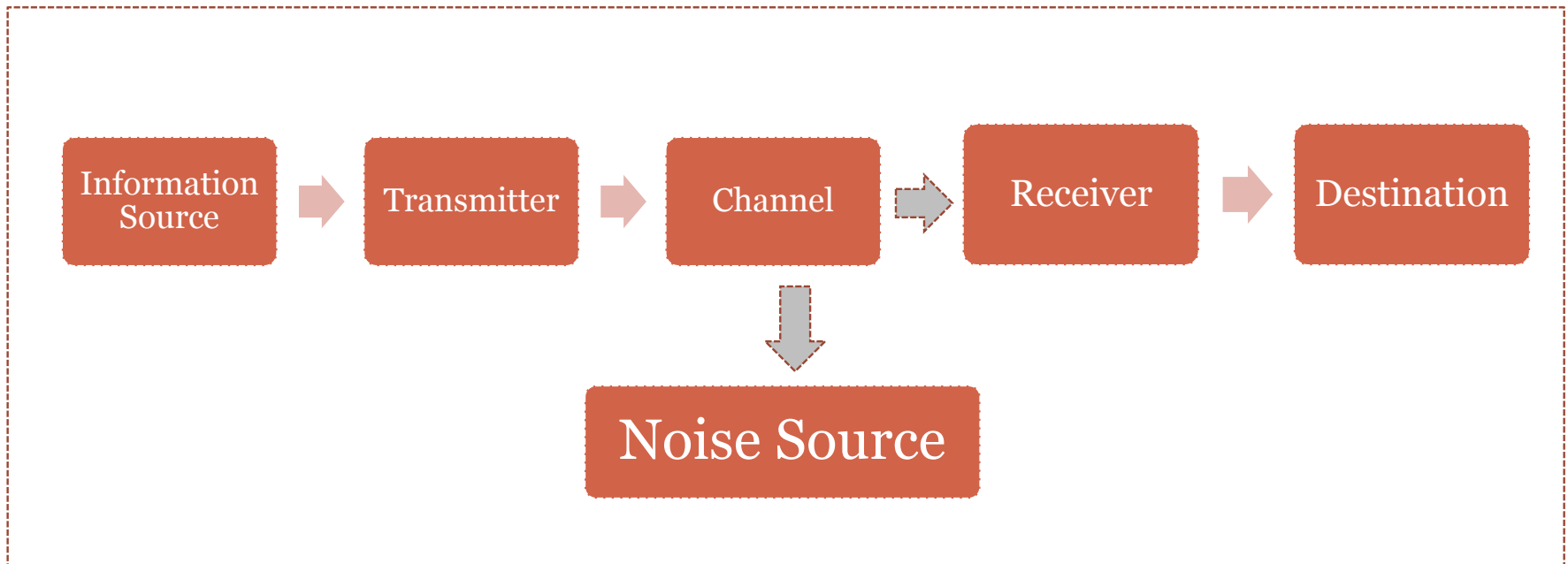
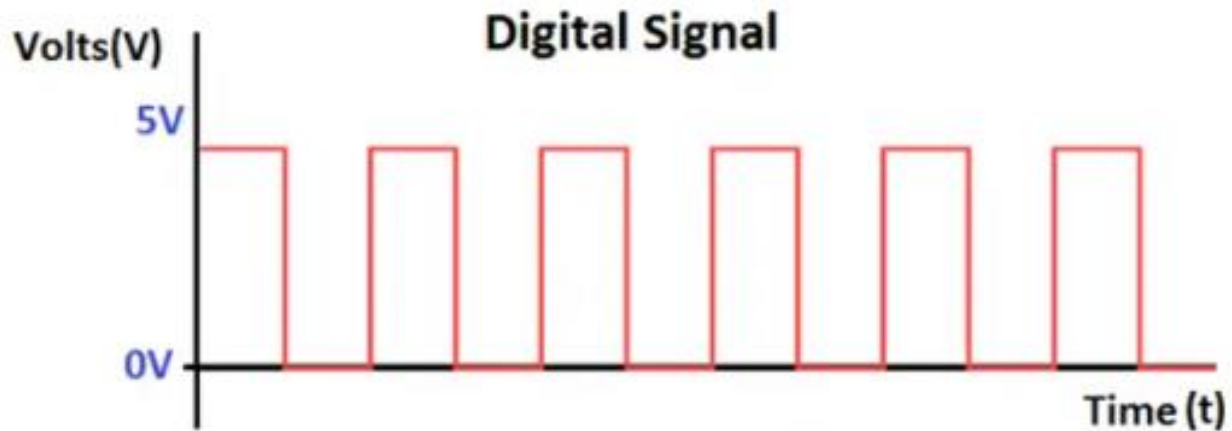
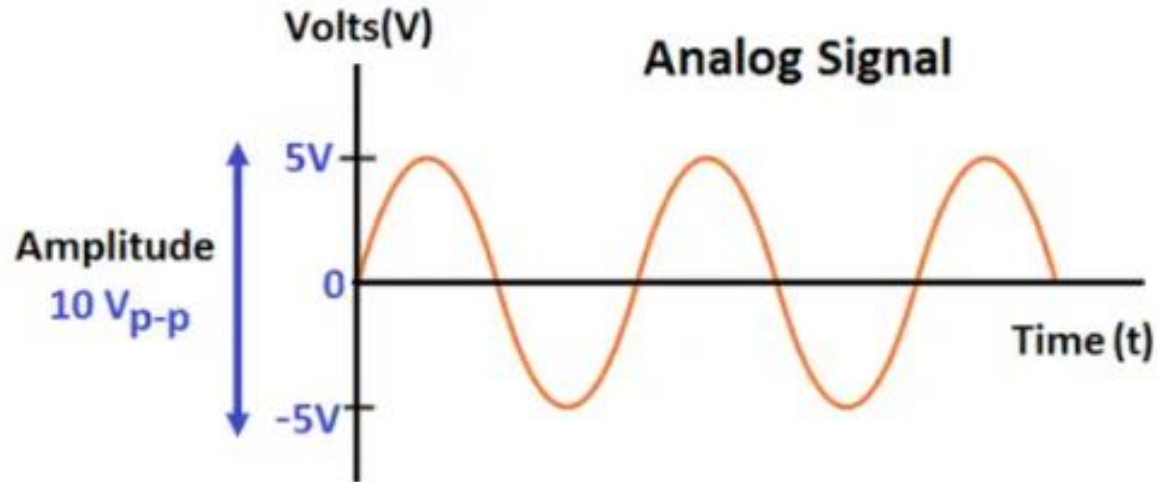
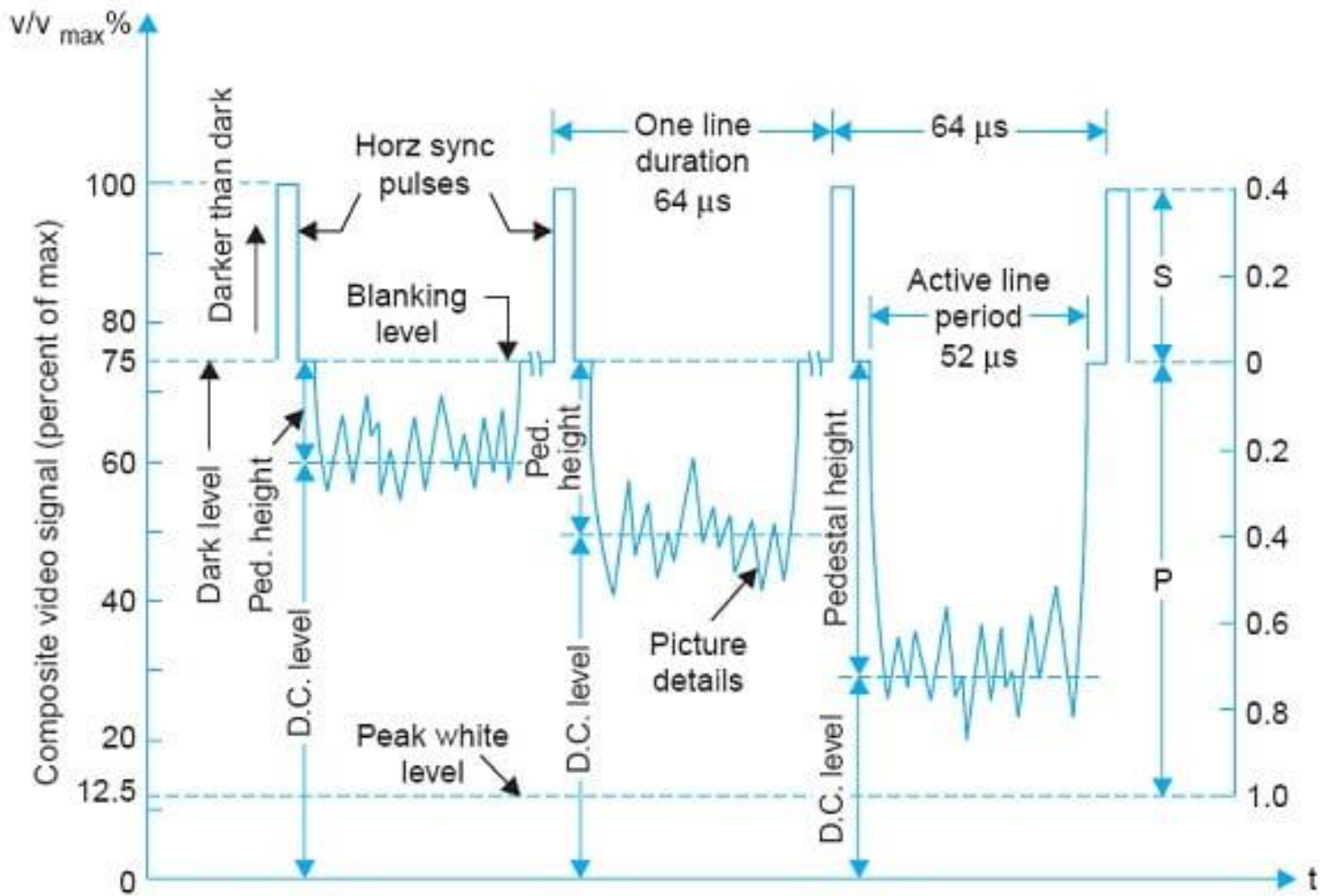

Fig: Block Diagram Of Telecommunication  
System

# Chapter: 02

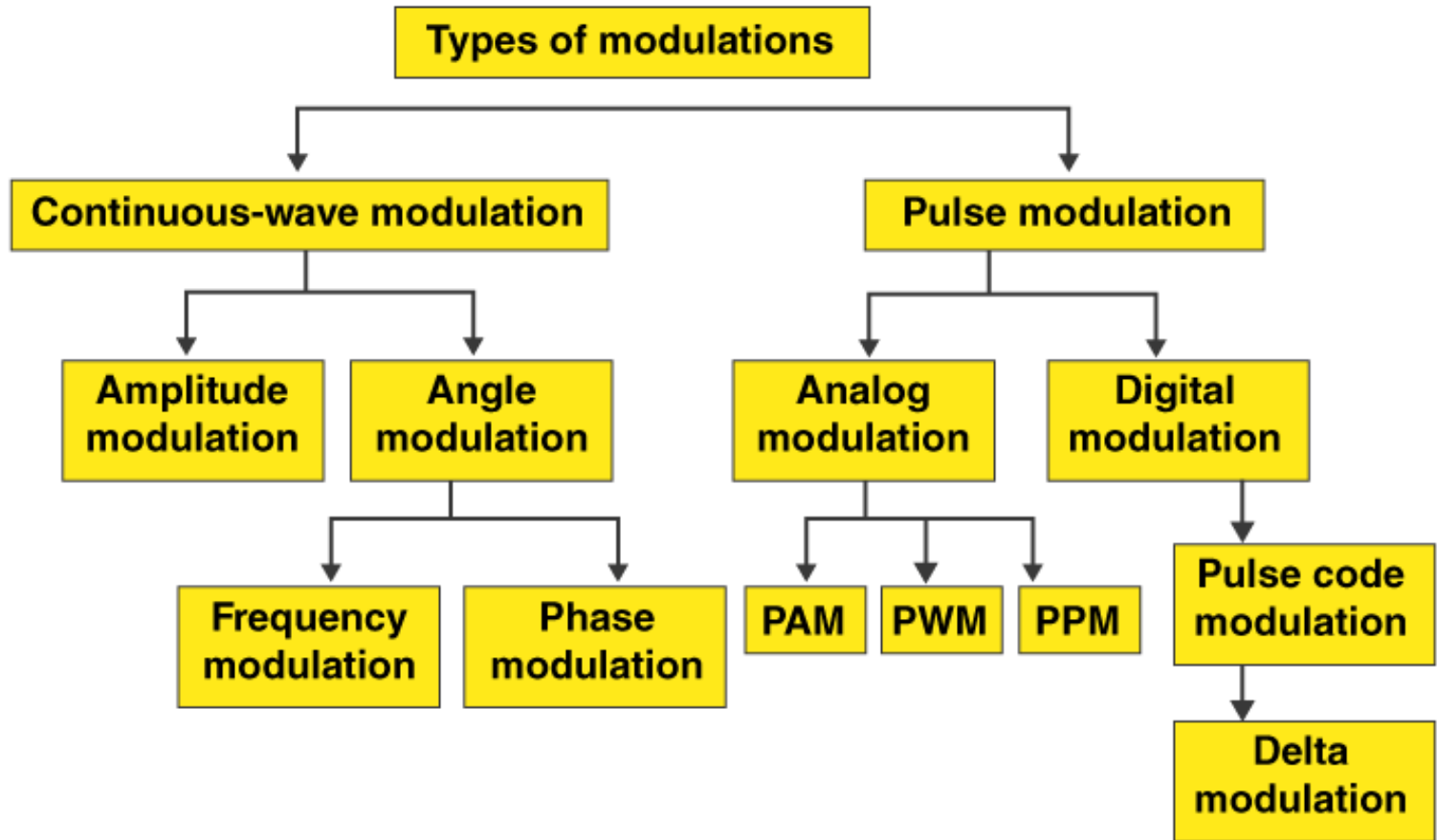

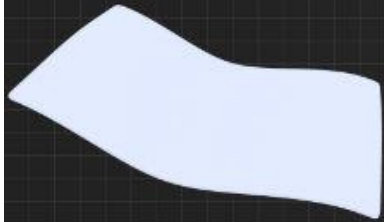

**Fig: Composite Video Signal**

# Chapter: 03

## Modulation





=

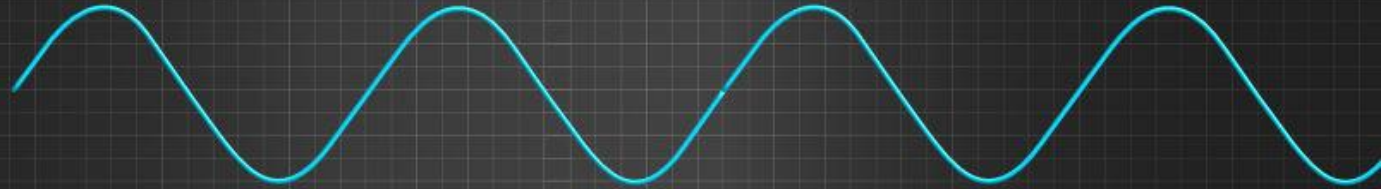

MESSAGE SIGNAL

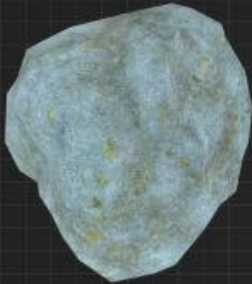

=

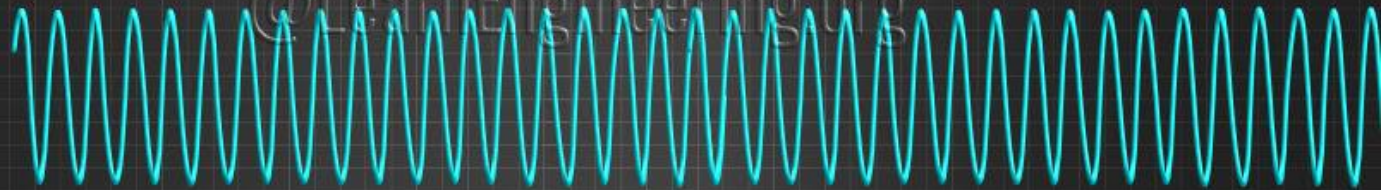

CARRIER SIGNAL

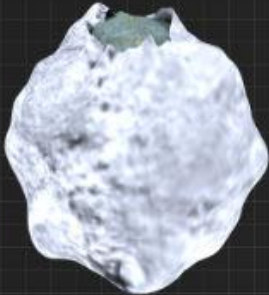

=

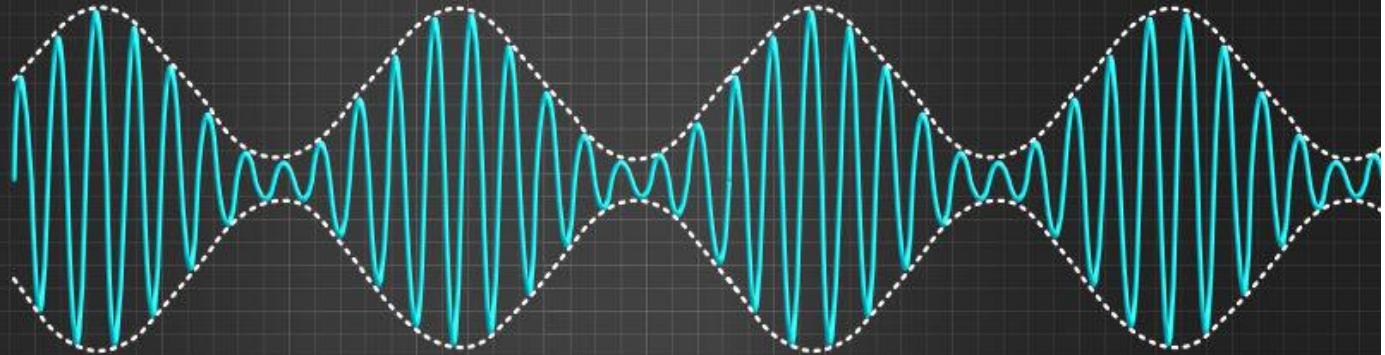

FREQUENCY MODULATED SIGNAL

@LearnEngineering.org

# Chapter: 04

## Modulator & Demodulator

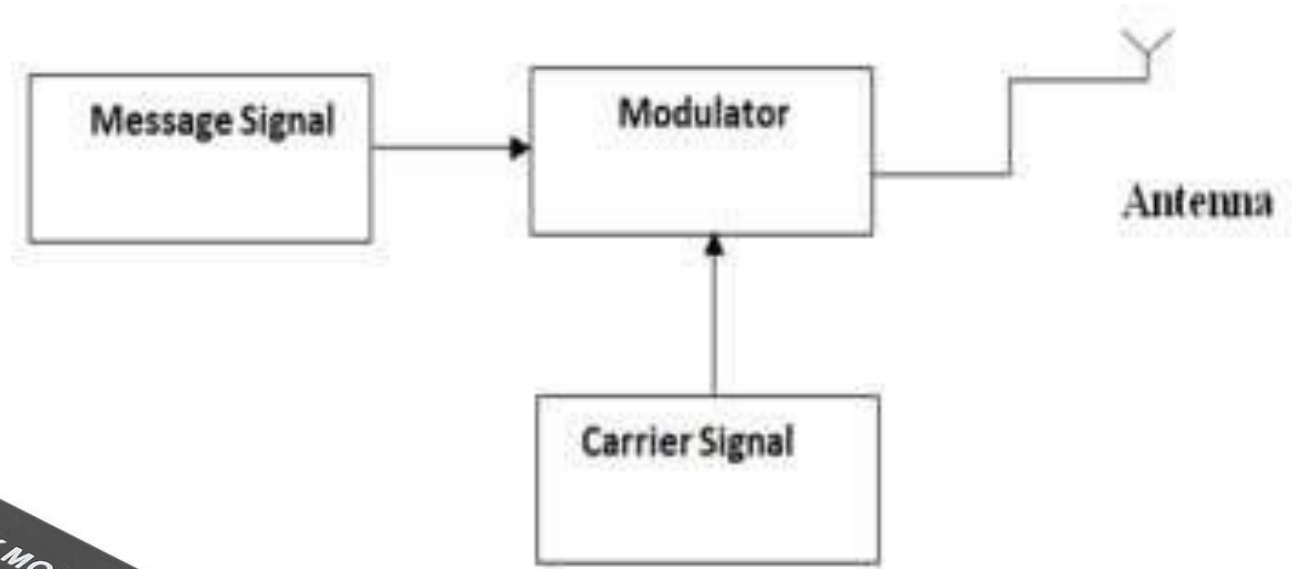

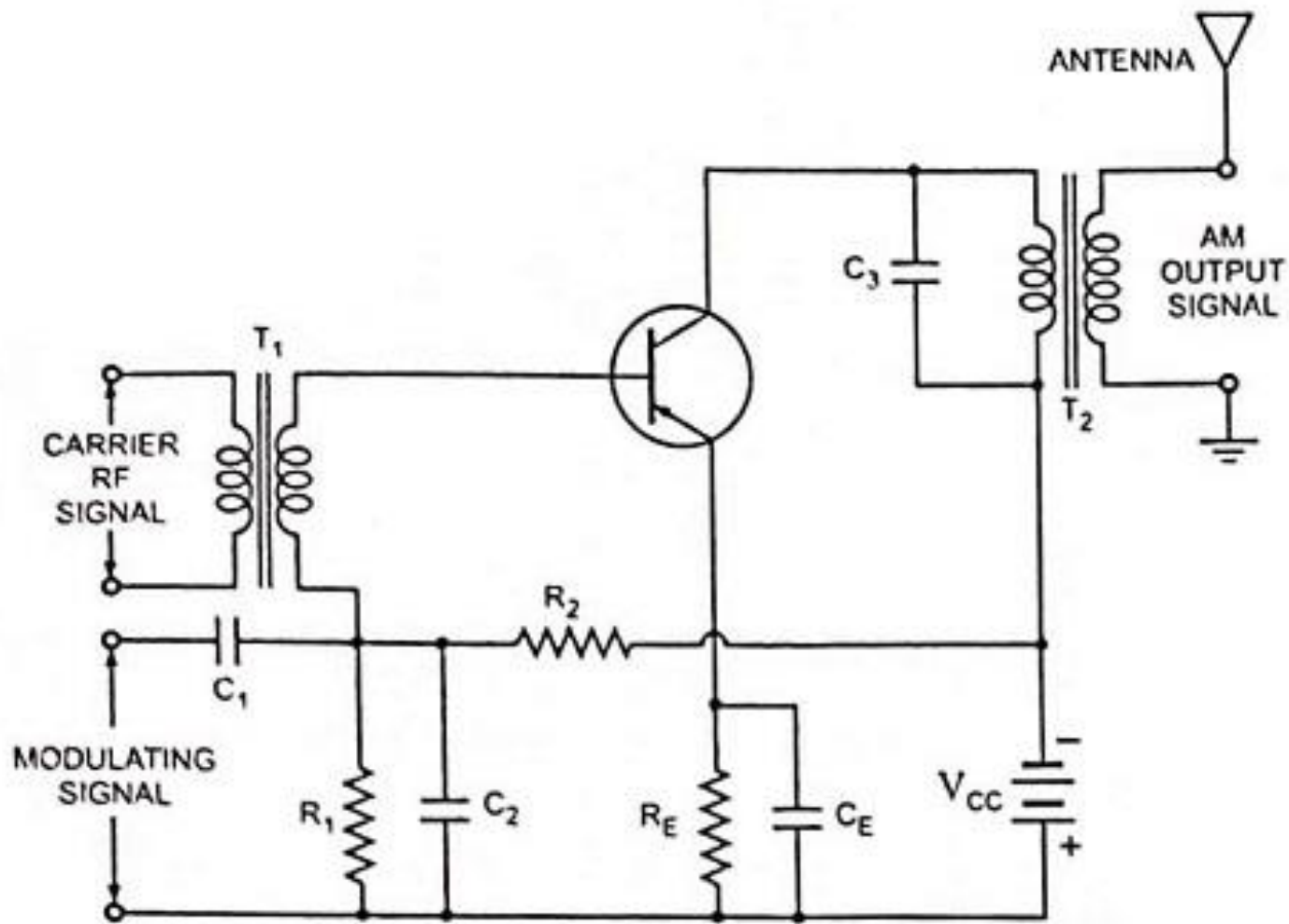

Fig. 22.28 Base Modulation Circuit

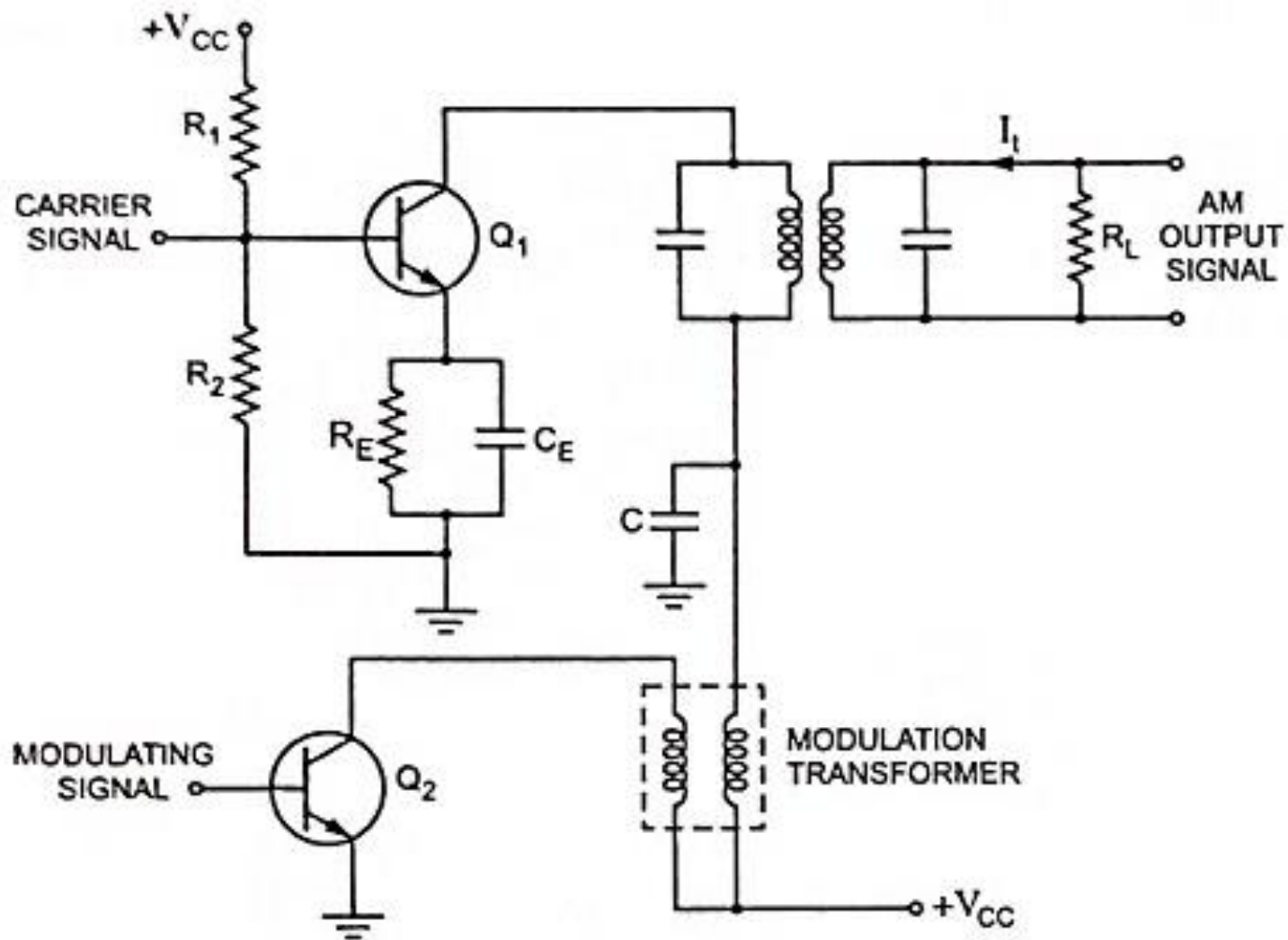

Fig. 22.26 Collector Modulation Circuit



