

গণপ্রজাতন্ত্রী বাংলাদেশ সরকার
পেটেন্ট, শিল্প-নকশা ও ট্রেডমার্কস অধিদপ্তর
শিল্প মন্ত্রণালয়
৯১, মতিঝিল বা/এ, ঢাকা-১০০০।
www.dpdt.gov.bd

নং-৩৬.০৮.০০০০.২০০.৯৯.০০২.২৪ ৫০২

তারিখঃ ২২/০৪/২৬ খ্রি.

বিষয়ঃ গৃহীত শিল্প-নকশা আবেদনসমূহ প্রকাশ

উপর্যুক্ত বিষয়ের প্রেক্ষিতে জানানো যাচ্ছে যে, অধিদপ্তরে দাখিলকৃত শিল্প-নকশা আবেদনসমূহের মধ্যে ৮৩টি শিল্প-নকশা আবেদন (সংযুক্ত) গৃহীত হয়েছে। গৃহীত উক্ত শিল্প-নকশা আবেদনসমূহ বাংলাদেশ শিল্প-নকশা আইন, ২০২৩ এর ধারা ১০(১) মোতাবেক প্রকাশ করা হলো।

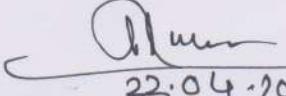
22.04.2026

(ড. অশোক কুমার রায়)

পরিচালক (শিল্প-নকশা)

পেটেন্ট, শিল্প-নকশা ও ট্রেডমার্কস অধিদপ্তর

ফোনঃ ০২-২২৩৩৫৭৮০২

অনুলিপিঃ

- ১। পরিচালক (সকল), পেটেন্ট, শিল্প-নকশা ও ট্রেডমার্কস অধিদপ্তর, ঢাকা।
- ২। সিস্টেম এনালিস্ট, পেটেন্ট, শিল্প-নকশা ও ট্রেডমার্কস অধিদপ্তর (ওয়েবসাইটে প্রকাশের অনুরোধসহ)।
- ৩। উপ-পরিচালক (সকল), পেটেন্ট, শিল্প-নকশা ও ট্রেডমার্কস অধিদপ্তর, ঢাকা।
- ৪। সহকারি পরিচালক (সকল), পেটেন্ট, শিল্প-নকশা ও ট্রেডমার্কস অধিদপ্তর, ঢাকা।
- ৫। মহাপরিচালক মহোদয়ের ব্যক্তিগত সহকারী, পেটেন্ট, শিল্প-নকশা ও ট্রেডমার্কস অধিদপ্তর, ঢাকা (মহাপরিচালক মহোদয়ের সদয় অবগতির জন্য)।



গণপ্রজাতন্ত্রী বাংলাদেশ সরকার
পেটেন্ট, শিল্প-নকশা ও ট্রেডমার্কস অধিদপ্তর
শিল্প মন্ত্রণালয়
৯১, মতিঝিল বা/এ, ঢাকা-১০০০।
www.dpdt.gov.bd

গৃহীত শিল্প-নকশা আবেদনসমূহ প্রকাশ
প্রকাশনা নং- ১০; তারিখ- ২২/০৪/২০২৬

এতদ্বারা জানানো যাচ্ছে যে, বাংলাদেশ শিল্প-নকশা আইন, ২০২৩ এর ধারা ১০(১) মোতাবেক গৃহীত শিল্প-নকশার আবেদনসমূহ প্রকাশ করা হল। উল্লিখিত প্রকাশনায় ৮৩টি গৃহীত শিল্প-নকশা (সংযুক্ত) রয়েছে। শিল্প-নকশার আবেদন প্রকাশের তারিখ হতে ৩০ (ত্রিশ) দিন পর্যন্ত উক্ত নিবন্ধন আবেদনের বিষয়ে আপত্তি দাখিল করবার জন্য উন্মুক্ত থাকবে। যে কোন পক্ষ আইন মোতাবেক প্রকাশনার তারিখ হতে ৩০ (ত্রিশ) দিনের মধ্যে মহাপরিচালক, পেটেন্ট, শিল্প-নকশা ও ট্রেডমার্কস অধিদপ্তর বরাবর শিল্প-নকশা নিবন্ধনের আবেদনের বিরোধিতার নোটিশ যথাযথ দলিলাদি/ প্রমানাদিসহ দাখিল করতে পারবেন।

উক্ত প্রকাশনা সম্পর্কিত বা যে কোনো তথ্য প্রাপ্তির জন্য মহাপরিচালক, পেটেন্ট, শিল্প-নকশা ও ট্রেডমার্কস অধিদপ্তর বরাবর যোগাযোগ করা যেতে পারে।

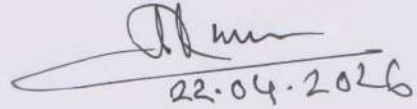
২২.০৪.২০২৬

(ড. অশোক কুমার রায়)
পরিচালক (শিল্প-নকশা)
পেটেন্ট, শিল্প-নকশা ও ট্রেডমার্কস অধিদপ্তর
ফোনঃ ০২-২২৩৩৫৭৮০২

ক্রমিক নং	ফাইল নম্বর	শ্রেণি	ক্রমিক নং	ফাইল নম্বর	শ্রেণি
০১	D-713/2024	09-03	৪৩	D-191/2025	09-03
০২	D-714/2024	09-03	৪৪	D-193/2025	09-03
০৩	D-769/2024	09-03	৪৫	D-194/2025	09-03
০৪	D-770/2024	09-03	৪৬	D-195/2025	09-03
০৫	D-803/2024	25-02	৪৭	D-196/2025	09-03
০৬	D-804/2024	25-02	৪৮	D-197/2025	09-03
০৭	D-805/2024	25-02	৪৯	D-198/2025	09-01
০৮	D-858/2024	08-99	৫০	D-214/2025	21-01
০৯	D-921/2024	09-99	৫১	D-215/2025	21-01
১০	D-974/2024	07-99	৫২	D-216/2025	21-01
১১	D-1012/2024	09-03	৫৩	D-218/2025	21-01
১২	D-1013/2024	09-03	৫৪	D-219/2025	21-01
১৩	D-1014/2024	09-03	৫৫	D-220/2025	07-01
১৪	D-1015/2024	09-01	৫৬	D-221/2025	07-01
১৫	D-1037/2024	21-01	৫৭	D-250/2025	09-03
১৬	D-1047/2024	21-01	৫৮	D-253/2025	09-03
১৭	D-03/2025	09-03	৫৯	D-254/2025	09-03
১৮	D-74/2025	09-03	৬০	D-255/2025	09-03
১৯	D-92/2025	09-01	৬১	D-256/2025	09-03
২০	D-94/2025	09-03	৬২	D-257/2025	09-03
২১	D-95/2025	09-99	৬৩	D-258/2025	09-03
২২	D-115/2025	21-01	৬৪	D-259/2025	09-03
২৩	D-116/2025	21-01	৬৫	D-260/2025	09-03
২৪	D-117/2025	21-01	৬৬	D-261/2025	09-03
২৫	D-127/2025	21-01	৬৭	D-262/2025	09-03
২৬	D-143/2025	12-11	৬৮	D-264/2025	09-03
২৭	D-148/2025	21-01	৬৯	D-265/2025	09-03
২৮	D-149/2025	21-01	৭০	D-266/2025	09-01
২৯	D-150/2025	21-01	৭১	D-267/2025	09-03
৩০	D-154/2025	21-01	৭২	D-268/2025	09-03
৩১	D-171/2025	02-99	৭৩	D-269/2025	09-03
৩২	D-172/2025	02-99	৭৪	D-270/2025	09-03
৩৩	D-173/2025	02-99	৭৫	D-271/2025	09-03
৩৪	D-174/2025	02-99	৭৬	D-273/2025	09-03
৩৫	D-175/2025	02-99	৭৭	D-274/2025	09-03
৩৬	D-176/2025	02-99	৭৮	D-276/2025	09-03
৩৭	D-177/2025	02-99	৭৯	D-278/2025	09-03
৩৮	D-178/2025	02-99	৮০	D-287/2025	12-11
৩৯	D-179/2025	02-99	৮১	D-288/2025	12-11
৪০	D-180/2025	02-99	৮২	D-289/2025	12-11
৪১	D-185/2025	21-01	৮৩	D-290/2025	12-11
৪২	D-190/2025	09-03			



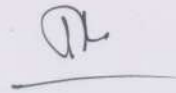



Government of the People’s Republic of Bangladesh
 Department of Patents, Industrial Designs & Trademarks
 Ministry of Industries
 91, Motijheel C/A, Dhaka-1000

"Published before acceptance under section 10(1) Proviso"

Application number	: BD-D-2024-713
Title	: Packet made of Hard Paper for Containing Brush UP MAX COOL Toothpaste Manufactured by Anfords Bangladesh Ltd.
Date	: 20/08/2024
Class	: 09-03
Owner & Address	: Anfords Bangladesh Ltd. 122, Tejgaon I/A, , Bangladesh
Service Address	: Anfords Bangladesh Ltd.
Priority	: N/A
Representation	: 



Government of the People's Republic of Bangladesh
 Department of Patents, Industrial Designs & Trademarks
 Ministry of Industries
 91, Motijheel C/A, Dhaka-1000

"Published before acceptance under section 10(1) Proviso"

Application number	: BD-D-2024-714
Title	: (BOXES, CASES, CONTAINERS, TIN CANS, AND PRESSURIZED CONTAINERS) which will be used for preserving Medicine manufactured by GHP Laboratory Pvt. Ltd.
Date	: 20/08/2024
Class	: 09-03
Owner & Address	: GHP Laboratory Pvt. Ltd. 235/1 BSCIC Road, Charipur, Bangladesh
Service Address	: GHP Laboratory Pvt. Ltd.
Priority	: N/A
Representation	: <div style="text-align: center;"> </div>



Government of the People’s Republic of Bangladesh
 Department of Patents, Industrial Designs & Trademarks
 Ministry of Industries
 91, Motijheel C/A, Dhaka-1000

"Published before acceptance under section 10(1) Proviso"

Application number	: BD-D-2024-769
Title	: Packet made of polypropylene which is use for Chanachur Manufactured by- “Fulban Food Products”
Date	: 19/09/2024
Class	: 09-03
Owner & Address	: Md. Mosaddek Hossain Jewel Fulban Food Products VutuaShreepur, Anandapur, Adursha Sadar, Comilla, Bangladesh
Service Address	: Md. Mosaddekhossain jewel Fulban Food Products
Priority	: N/A
Representation	: 



Government of the People's Republic of Bangladesh
 Department of Patents, Industrial Designs & Trademarks
 Ministry of Industries
 91, Motijheel C/A, Dhaka-1000



"Published before acceptance under section 10(1) Proviso"

Application number	: BD-D-2024-770
Title	: Packet made of polypropylene which is use for Lashcha Shemai Manufactured by- "Fulban Food Products"
Date	: 19/09/2024
Class	: 09-03
Owner & Address	: Md. Mosaddek hossain jewel Fulban Food Products VutuaShreepur, Anandapur, Adursha Sadar, Comilla, Bangladesh
Service Address	: Md. Mosaddek hossain jewel Fulban Food Products
Priority	: N/A
Representation	: 



Government of the People's Republic of Bangladesh
 Department of Patents, Industrial Designs & Trademarks
 Ministry of Industries
 91, Motijheel C/A, Dhaka-1000



"Published before acceptance under section 10(1) Proviso"

Application number	: BD-D-2024-803
Title	: Wood door Made by Caprash Woodland Ltd.
Date	: 07/10/2024
Class	: 25-02
Owner & Address	: Caprash Woodland Ltd. Star Shopping City, Plot-1193/A, Block-A, Bashundhara Riverview, Hasnabad, Keraniganj, Bangladesh
Service Address	: Caprash Woodland Ltd.
Priority	: N/A
Representation	:

Government of the People's Republic of Bangladesh
Department of Patents, Industrial Designs & Trademarks
Ministry of Industries
91, Motijheel C/A, Dhaka-1000

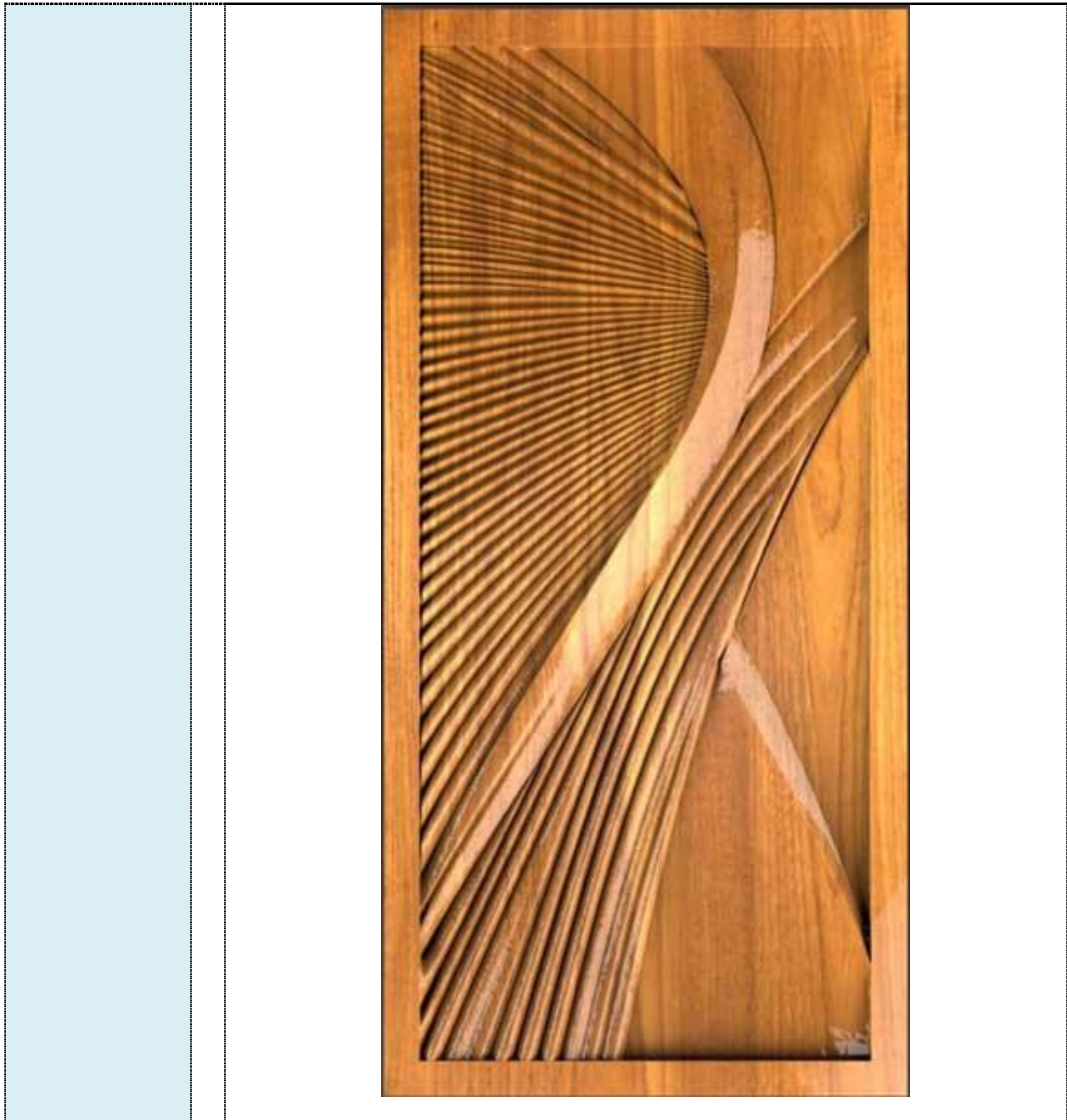



Government of the People's Republic of Bangladesh
 Department of Patents, Industrial Designs & Trademarks
 Ministry of Industries
 91, Motijheel C/A, Dhaka-1000



"Published before acceptance under section 10(1) Proviso"

Application number	: BD-D-2024-804
Title	: Wood door Made by Caprash Woodland Ltd.
Date	: 07/10/2024
Class	: 25-02
Owner & Address	: Caprash Woodland Ltd. Star Shopping City, Plot-1193/A, Block-A, Bashundhara Riverview, Hasnabad, Keraniganj, Bangladesh
Service Address	: Caprash Woodland Ltd.
Priority	: N/A
Representation	:

Government of the People's Republic of Bangladesh
Department of Patents, Industrial Designs & Trademarks
Ministry of Industries
91, Motijheel C/A, Dhaka-1000





Government of the People's Republic of Bangladesh
 Department of Patents, Industrial Designs & Trademarks
 Ministry of Industries
 91, Motijheel C/A, Dhaka-1000



"Published before acceptance under section 10(1) Proviso"

Application number	: BD-D-2024-805
Title	: Wood door Made by Caprash Woodland Ltd.
Date	: 07/10/2024
Class	: 25-02
Owner & Address	: Caprash Woodland Ltd. Star Shopping City, Plot-1193/A, Block-A, Bashundhara Riverview, Hasnabad, Keraniganj, Bangladesh
Service Address	: Caprash Woodland Ltd.
Priority	: N/A
Representation	:

Government of the People's Republic of Bangladesh
Department of Patents, Industrial Designs & Trademarks
Ministry of Industries
91, Motijheel C/A, Dhaka-1000

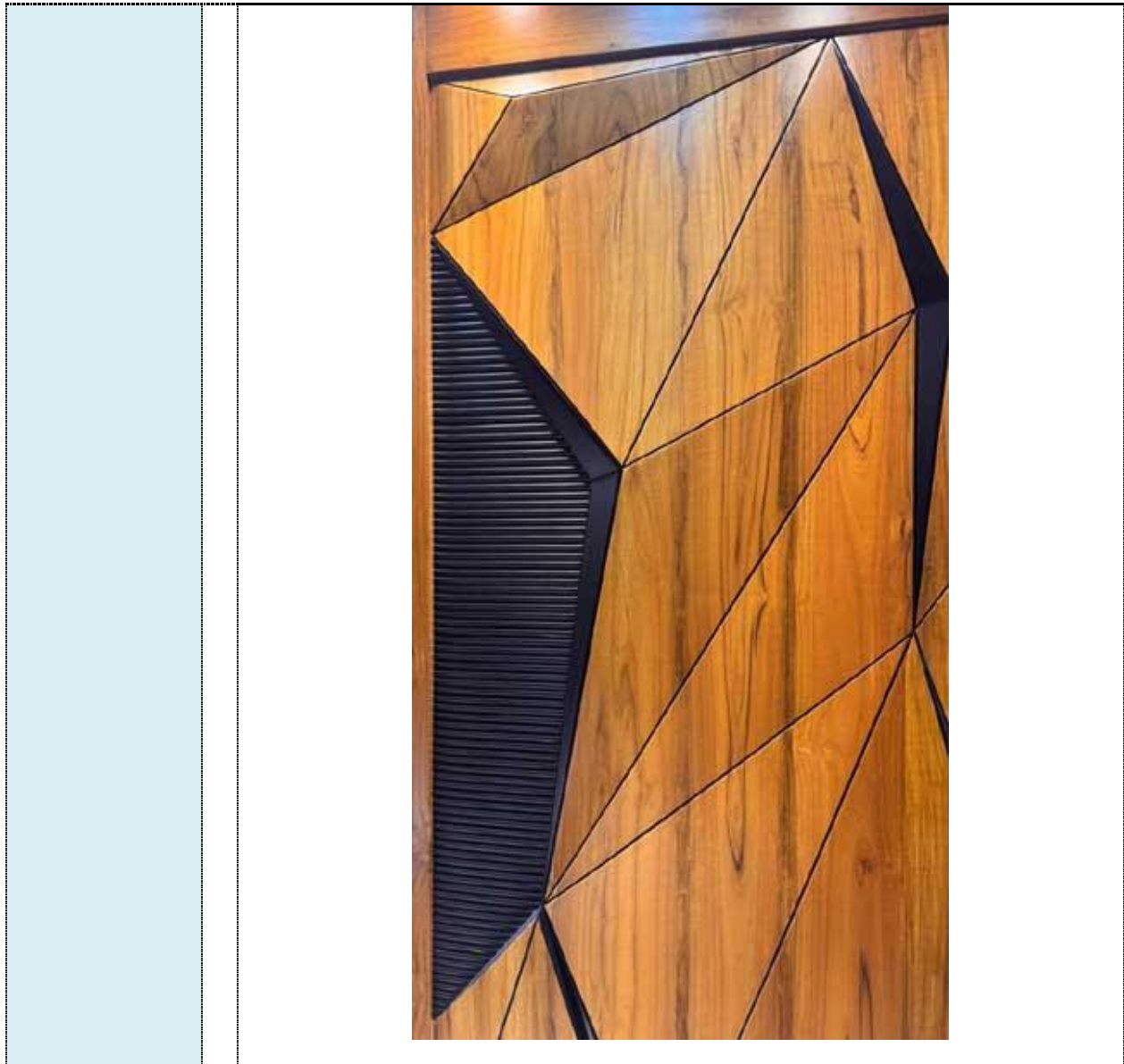



Government of the People’s Republic of Bangladesh
 Department of Patents, Industrial Designs & Trademarks
 Ministry of Industries
 91, Motijheel C/A, Dhaka-1000

"Published before acceptance under section 10(1) Proviso"

Application number	: BD-D-2024-858
Title	: HW Brand Grinding and Cutting Wheels
Date	: 31/10/2024
Class	: 08-99
Owner & Address	: Mohammed Ejaz Gaffar HEREWAY INTERNATIONAL 198-202 Nawabpur Road, Bangladesh
Service Address	: Motassir Ahmed
Priority	: N/A
Representation	: 



Government of the People’s Republic of Bangladesh
 Department of Patents, Industrial Designs & Trademarks
 Ministry of Industries
 91, Motijheel C/A, Dhaka-1000

"Published before acceptance under section 10(1) Proviso"

Application number	: BD-D-2024-921
Title	: the Packet of foil paper for Containing Cocola Edible Gel Happy Jelly Manufactured by Cocola Food Products Ltd.
Date	: 20/11/2024
Class	: 09-99
Owner & Address	: Cocola Food Products Ltd. 942, Mouchak, Kaliakoir, Bangladesh
Service Address	: Md. Saifur Rahman
Priority	: N/A
Representation	: 



Government of the People's Republic of Bangladesh
 Department of Patents, Industrial Designs & Trademarks
 Ministry of Industries
 91, Motijheel C/A, Dhaka-1000



"Published before acceptance under section 10(1) Proviso"

Application number	: BD-D-2024-974
Title	: Imposed design of valve manufactured by MB International
Date	: 04/12/2024
Class	: 07-99
Owner & Address	: Mohammad Bazlur Rahman MB International 81, Lutfor Rahman Len, Bangladesh
Service Address	: Mohammad Bazlur Rahman MB International
Priority	: N/A
Representation	: <div style="text-align: center;">  <p>Front Side</p> </div>

Government of the People's Republic of Bangladesh
Department of Patents, Industrial Designs & Trademarks
Ministry of Industries
91, Motijheel C/A, Dhaka-1000



Government of the People's Republic of Bangladesh
Department of Patents, Industrial Designs & Trademarks
Ministry of Industries
91, Motijheel C/A, Dhaka-1000



Government of the People's Republic of Bangladesh
Department of Patents, Industrial Designs & Trademarks
Ministry of Industries
91, Motijheel C/A, Dhaka-1000





Government of the People's Republic of Bangladesh
 Department of Patents, Industrial Designs & Trademarks
 Ministry of Industries
 91, Motijheel C/A, Dhaka-1000



"Published before acceptance under section 10(1) Proviso"

Application number	: BD-D-2024-1012
Title	: The design is to be applied to Packet of Saba Jhalmuri made of Polypropylene Manufactured by Chef Food Industries.
Date	: 09/12/2024
Class	: 09-03
Owner & Address	: Mohammad Safiqul Islam, Proprietor, Chef Food Industries Village-Kanaipur Post-Kanaipur, Sadar, Faridpur , Bangladesh
Service Address	: Mohammad Safiqul Islam, Proprietor, Chef Food Industries
Priority	: N/A
Representation	: 



Government of the People's Republic of Bangladesh
 Department of Patents, Industrial Designs & Trademarks
 Ministry of Industries
 91, Motijheel C/A, Dhaka-1000

"Published before acceptance under section 10(1) Proviso"

Application number	: BD-D-2024-1013
Title	: Packet of ShuddahJhalmuri made of Polypropylene Manufactured by Chef Food Industries
Date	: 09/12/2024
Class	: 09-03
Owner & Address	: Mohammad Safiqul Islam Chef Food Industries Village-Kanaipur Post-Kanaipur, Bangladesh
Service Address	: Mohammad Safiqul Islam Chef Food Industries
Priority	: N/A
Representation	: 



Government of the People's Republic of Bangladesh
 Department of Patents, Industrial Designs & Trademarks
 Ministry of Industries
 91, Motijheel C/A, Dhaka-1000



"Published before acceptance under section 10(1) Proviso"

Application number	: BD-D-2024-1014
Title	: Packet of Shuddah Kurmure made of Polypropylene Manufactured by Chef Food Industries
Date	: 09/12/2024
Class	: 09-03
Owner & Address	: Mohammad Safiqul Islam Chef Food Industries Village-Kanaipur Post-Kanaipur, Bangladesh
Service Address	: Mohammad Safiqul Islam Chef Food Industries
Priority	: N/A
Representation	: 



Government of the People's Republic of Bangladesh
 Department of Patents, Industrial Designs & Trademarks
 Ministry of Industries
 91, Motijheel C/A, Dhaka-1000



"Published before acceptance under section 10(1) Proviso"

Application number	: BD-D-2024-1015
Title	: Packet made of Poly Propylene (Polythene) for Containing Muna Chips Manufactured by Shahi Food Products
Date	: 09/12/2024
Class	: 09-01
Owner & Address	: Md. Nurul Islam Shahi Food Products Kanaipur Bazar, Kanaipur-7801, Faridpur Sadar, , Bangladesh
Service Address	: Md. Nurul Islam Shahi Food Products
Priority	: N/A
Representation	: 



Government of the People's Republic of Bangladesh
 Department of Patents, Industrial Designs & Trademarks
 Ministry of Industries
 91, Motijheel C/A, Dhaka-1000

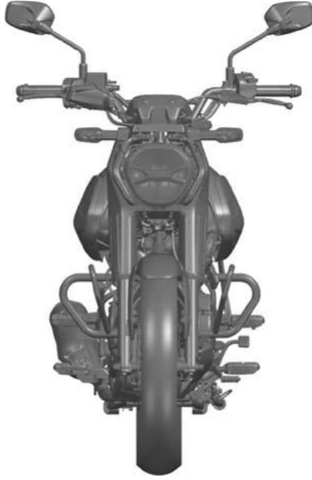

"Published before acceptance under section 10(1) Proviso"

Application number	: BD-D-2024-1037
Title	: MOTORCYCLE
Date	: 19/12/2024
Class	: 12-11
Owner & Address	: Bajaj Auto Limited Bajaj Auto Limited,, India
Service Address	: Md. Zahirul Islam
Priority	: 421825001
Representation	: <div style="text-align: center;">  FRONT VIEW </div>

Government of the People's Republic of Bangladesh
Department of Patents, Industrial Designs & Trademarks
Ministry of Industries
91, Motijheel C/A, Dhaka-1000



RIGHT FRONT PERSPECTIVE VIEW



RIGHT HAND SIDE VIEW

Government of the People's Republic of Bangladesh
Department of Patents, Industrial Designs & Trademarks
Ministry of Industries
91, Motijheel C/A, Dhaka-1000



RIGHT REAR PERSPECTIVE VIEW

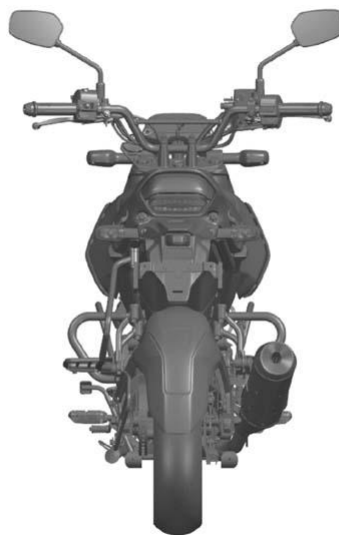

REAR VIEW

Government of the People's Republic of Bangladesh
Department of Patents, Industrial Designs & Trademarks
Ministry of Industries
91, Motijheel C/A, Dhaka-1000



LEFT REAR PERSPECTIVE VIEW



LEFT HAND SIDE VIEW

Government of the People's Republic of Bangladesh
Department of Patents, Industrial Designs & Trademarks
Ministry of Industries
91, Motijheel C/A, Dhaka-1000



LEFT FRONT PERSPECTIVE VIEW

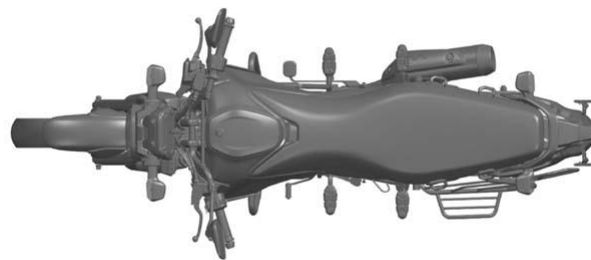

TOP VIEW

Government of the People's Republic of Bangladesh
Department of Patents, Industrial Designs & Trademarks
Ministry of Industries
91, Motijheel C/A, Dhaka-1000

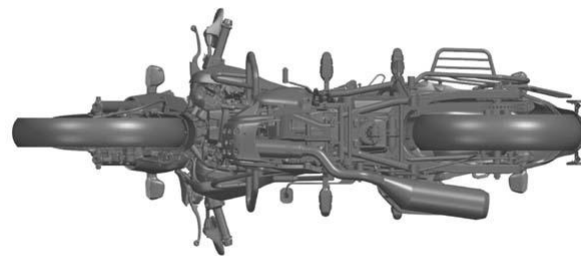

BOTTOM VIEW



PERSPECTIVE VIEW



Government of the People's Republic of Bangladesh
 Department of Patents, Industrial Designs & Trademarks
 Ministry of Industries
 91, Motijheel C/A, Dhaka-1000



"Published before acceptance under section 10(1) Proviso"

Application number	: BD-D-2024-1047
Title	: Plastic Design of which will we use for TAJ E BABY BIKE manufactured by M/S. Sadek Plastic Industries
Date	: 22/12/2024
Class	: 21-01
Owner & Address	: Abdul Gaffar M/S. Sadek Plastic Industries 54, B K Ganguli Lane, Bangladesh
Service Address	: Md. Jamirul Islam
Priority	: N/A
Representation	: <div style="text-align: center;">  <p>TAJ E BABY BIKE</p> </div>



Government of the People's Republic of Bangladesh
 Department of Patents, Industrial Designs & Trademarks
 Ministry of Industries
 91, Motijheel C/A, Dhaka-1000



"Published before acceptance under section 10(1) Proviso"

Application number	: BD-D-2025-3
Title	: Packaging for food stuffs- Manufactured by New Anowara Automatic Rice Mill.
Date	: 06/01/2025
Class	: 09-03
Owner & Address	: Mohammad Delwor Hossen New Anowara Automatic Rice Mill Ward No-02, Subidhat, Setabganj, Dinajpur, 5216, Bangladesh., Bangladesh
Service Address	: Mohammad Delwor Hossen New Anowara Automatic Rice Mill
Priority	: N/A
Representation	:

Government of the People's Republic of Bangladesh
Department of Patents, Industrial Designs & Trademarks
Ministry of Industries
91, Motijheel C/A, Dhaka-1000

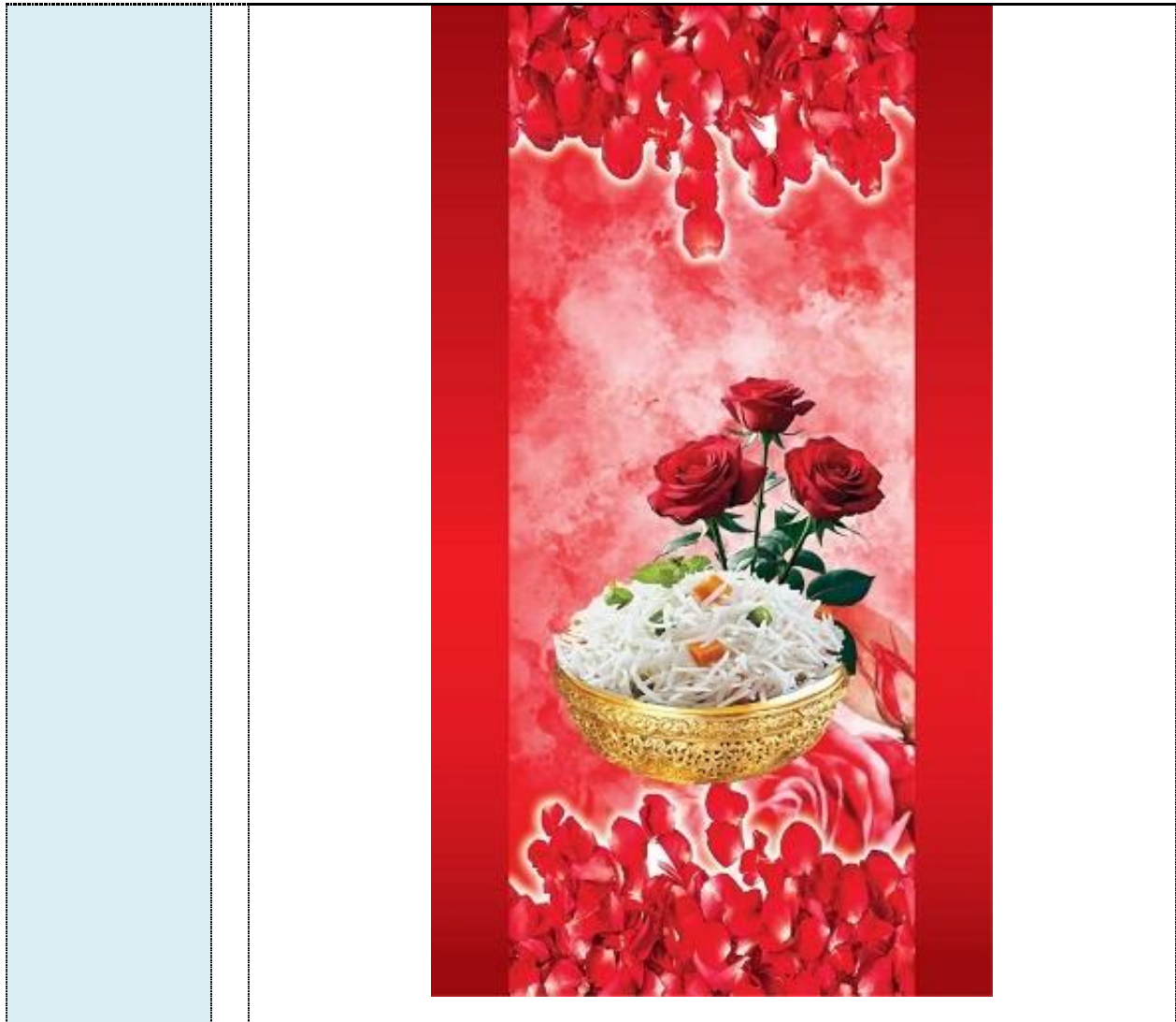



Government of the People's Republic of Bangladesh
 Department of Patents, Industrial Designs & Trademarks
 Ministry of Industries
 91, Motijheel C/A, Dhaka-1000



"Published before acceptance under section 10(1) Proviso"

Application number	: BD-D-2025-74
Title	: Lebel (BOXES, CASES, CONTAINERS, TIN CANS) Manufactured by R K Enterprise
Date	: 11/02/2025
Class	: 09-03
Owner & Address	: Md. Anamul Haque Khandaker R K Enterprise Village: Krishnapur, Post Office: Krishnapur-3540, Upazila: Muradnagar, Bangladesh
Service Address	: Md. Anamul Haque Khandaker R K Enterprise
Priority	: N/A
Representation	:



Government of the People's Republic of Bangladesh
 Department of Patents, Industrial Designs & Trademarks
 Ministry of Industries
 91, Motijheel C/A, Dhaka-1000



"Published before acceptance under section 10(1) Proviso"

Application number	: BD-D-2025-92
Title	: CONTAINER for Cosmetics Manufactured by KIM Cosmetics Company Ltd.
Date	: 19/02/2025
Class	: 09-01
Owner & Address	: KIM Cosmetics Company Ltd. 59/31-A, Polash Nagar, Bangladesh
Service Address	: KIM Cosmetics Company Ltd.
Priority	: N/A
Representation	: <div style="text-align: center;">  <p>Top view Bottom view</p> <p>Side View</p> </div>



Government of the People's Republic of Bangladesh
 Department of Patents, Industrial Designs & Trademarks
 Ministry of Industries
 91, Motijheel C/A, Dhaka-1000

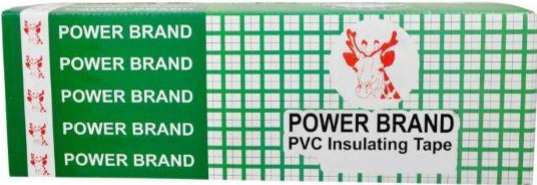

"Published before acceptance under section 10(1) Proviso"

Application number	: BD-D-2025-94
Title	: This Design has been applied to the packaging box for power Brand insulating tape with the giraffe logo manufactured by SAQIB AHMED SHAMSI.
Date	: 19/02/2025
Class	: 09-03
Owner & Address	: SAQIB AHMED SHAMSI SAQIB AHMED SHAMSI New Eskaton Road, Bangladesh
Service Address	: Motassir Ahmed
Priority	: N/A
Representation	: 

Government of the People's Republic of Bangladesh
Department of Patents, Industrial Designs & Trademarks
Ministry of Industries
91, Motijheel C/A, Dhaka-1000

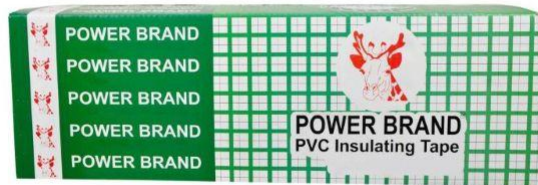



Government of the People's Republic of Bangladesh
 Department of Patents, Industrial Designs & Trademarks
 Ministry of Industries
 91, Motijheel C/A, Dhaka-1000

"Published before acceptance under section 10(1) Proviso"

Application number	: BD-D-2025-95
Title	: This Design has been applied to the Power brand insulating tape packaging with the giraffe logo manufactured by SAQIB AHMED SHAMSI.
Date	: 19/02/2025
Class	: 09-99
Owner & Address	: SAQIB AHMED SHAMSI SAQIB AHMED SHAMSI New Eskaton Road, Bangladesh
Service Address	: Motassir Ahmed
Priority	: N/A
Representation	: 



Government of the People's Republic of Bangladesh
 Department of Patents, Industrial Designs & Trademarks
 Ministry of Industries
 91, Motijheel C/A, Dhaka-1000

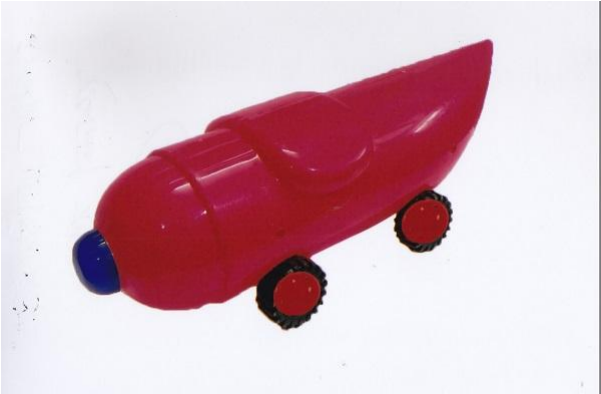

"Published before acceptance under section 10(1) Proviso"

Application number	: BD-D-2025-115
Title	: toy car manufactured by Islam Plastic Industris
Date	: 26/02/2025
Class	: 21-01
Owner & Address	: MD. Fakhurul Islam, Proprietor, Islam Plastic Industris 22/1/1, East Islambagh Posta, Bangladesh
Service Address	: MD. Fakhurul Islam, Proprietor, Islam Plastic Industris
Priority	: N/A
Representation	: 



Government of the People's Republic of Bangladesh
 Department of Patents, Industrial Designs & Trademarks
 Ministry of Industries
 91, Motijheel C/A, Dhaka-1000



"Published before acceptance under section 10(1) Proviso"

Application number	: BD-D-2025-116
Title	: toy jug manufactured by Abdur Rob Plastic
Date	: 26/02/2025
Class	: 21-01
Owner & Address	: MD. Abdur Rob, Proprietor, Abdur Rob Plastic 60/1, Water Works Road, Bangladesh
Service Address	: MD. Abdur Rob, Proprietor, Abdur Rob Plastic
Priority	: N/A
Representation	: 



Government of the People's Republic of Bangladesh
 Department of Patents, Industrial Designs & Trademarks
 Ministry of Industries
 91, Motijheel C/A, Dhaka-1000



"Published before acceptance under section 10(1) Proviso"

Application number	: BD-D-2025-117
Title	: toy magnet block set manufactured by Tazul Plastic Toys Ind.
Date	: 26/02/2025
Class	: 21-01
Owner & Address	: MD. Sirajul Islam (Tazul), Proprietor, Tazul Plastic Toys Ind. Atashur, Brahman Kitta, Keraniganj Model, Bangladesh
Service Address	: MD. Sirajul Islam (Tazul), Proprietor, Tazul Plastic Toys Ind.
Priority	: N/A
Representation	: 



Government of the People's Republic of Bangladesh
 Department of Patents, Industrial Designs & Trademarks
 Ministry of Industries
 91, Motijheel C/A, Dhaka-1000



"Published before acceptance under section 10(1) Proviso"

Application number	: BD-D-2025-127
Title	: Toy Remote Racing Car Set manufactured by Aman Toy Garden
Date	: 06/03/2025
Class	: 21-01
Owner & Address	: Md. Aman Ullah, Proprietor, Aman Toy Garden BSCIC Industrial Area, Plot No. A-24, Ruhitpur, Keraniganj Model, Bangladesh
Service Address	: Md. Aman Ullah, Proprietor, Aman Toy Garden
Priority	: N/A
Representation	: 



Government of the People's Republic of Bangladesh
 Department of Patents, Industrial Designs & Trademarks
 Ministry of Industries
 91, Motijheel C/A, Dhaka-1000



"Published before acceptance under section 10(1) Proviso"

Application number	: BD-D-2025-143
Title	: The design pertains to a Fun, Iconic and Urban motorcycle. The motorcycle has Uni-body sculptural design and a naked fairing. The motorcycle includes floating body panels supported by its strong core structure which influence aerodynamics. The floating panels on the headlight, tank lower area and seat cowl improves the overall aesthetics of the motorcycle. The motorcycle has central muscular metal tank with shrouds on either side. The motorcycle tank flaps and lower shrouds have strong character lines depicting speed and aggression. The motorcycle has split pillion seat configuration, contoured and lowered rider seat for better ground reach and improved comfort. The sharp and chiselled LED headlamp enhances the mean and aggressive look. The fork sleeves add to the butch and confident frontal stance while providing protection to the forks from dust and muck. The black central cowl piece at rear, neatly houses the tail lamp. The tail lamp shape is evolution of 'signature Twin streak' - Manufactured by Bajaj Auto Limited.
Date	: 12/03/2025
Class	: 12-11
Owner & Address	: Bajaj Auto Limited Bajaj Auto Limited, Mumbai-Pune Road , India
Service Address	: MOTASSIR AHMED
Priority	: 432033001
Representation	:

Government of the People's Republic of Bangladesh
Department of Patents, Industrial Designs & Trademarks
Ministry of Industries
91, Motijheel C/A, Dhaka-1000

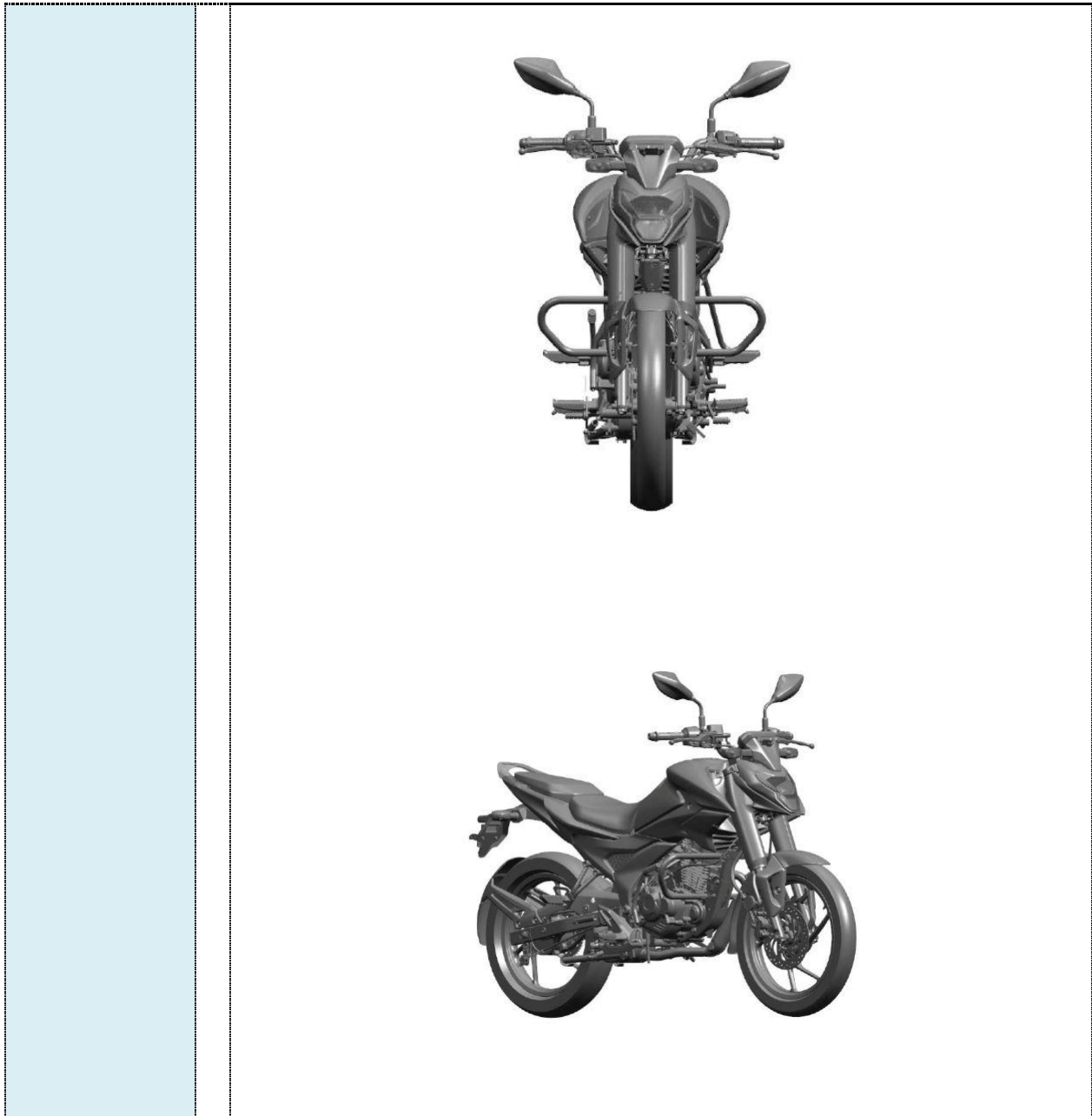

Government of the People's Republic of Bangladesh
Department of Patents, Industrial Designs & Trademarks
Ministry of Industries
91, Motijheel C/A, Dhaka-1000



Government of the People's Republic of Bangladesh
Department of Patents, Industrial Designs & Trademarks
Ministry of Industries
91, Motijheel C/A, Dhaka-1000

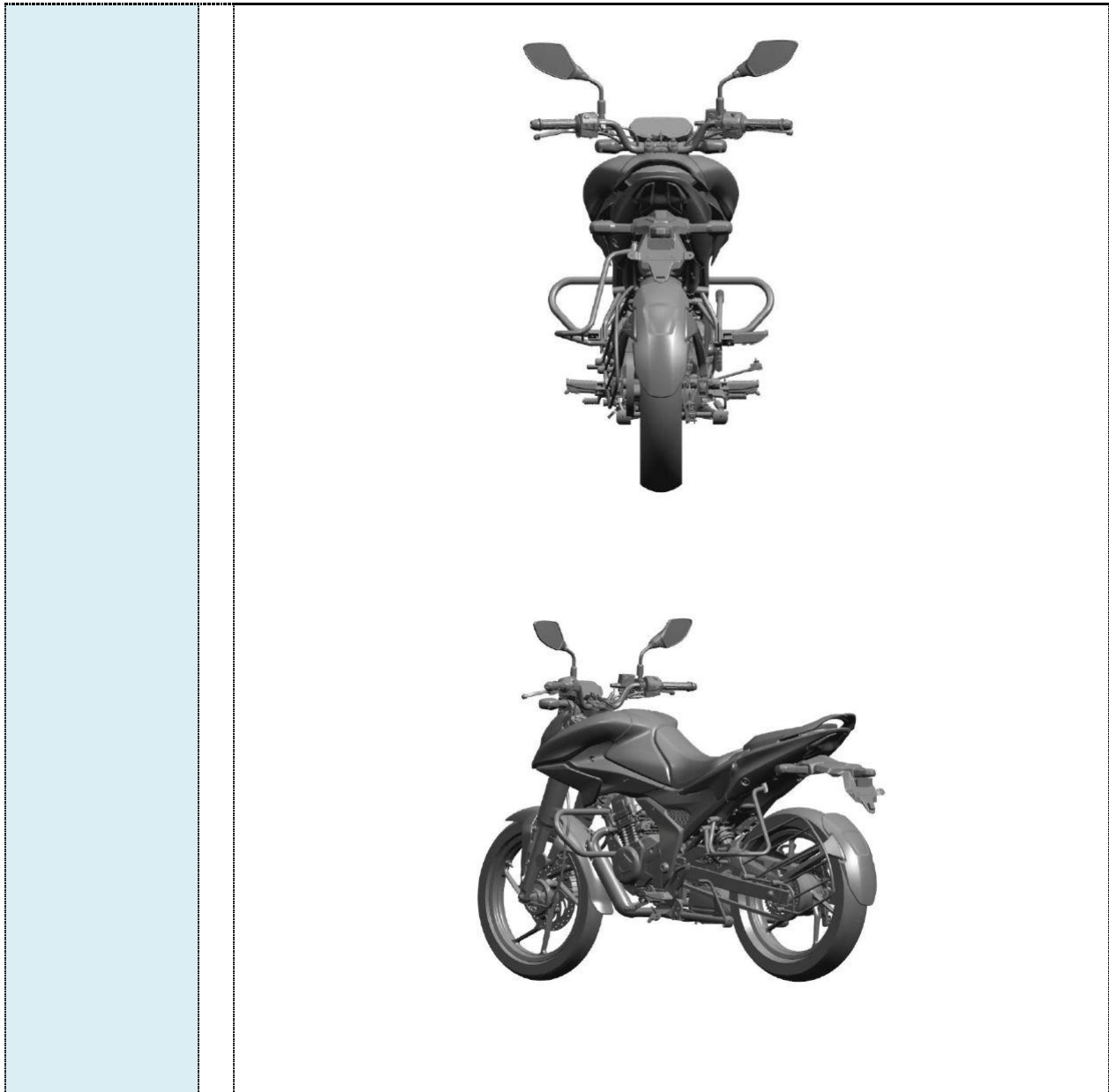

Government of the People's Republic of Bangladesh
Department of Patents, Industrial Designs & Trademarks
Ministry of Industries
91, Motijheel C/A, Dhaka-1000

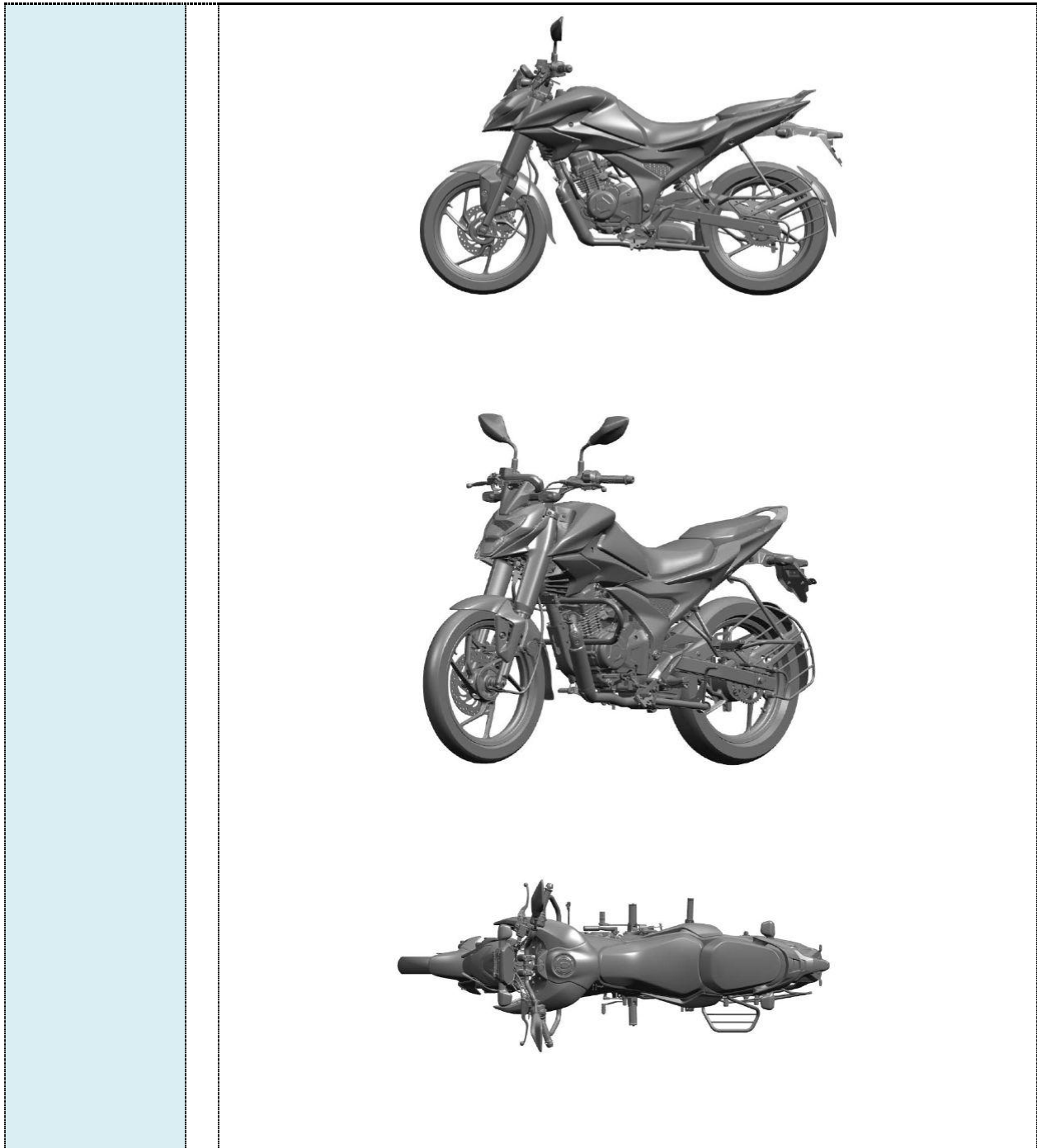

Government of the People's Republic of Bangladesh
Department of Patents, Industrial Designs & Trademarks
Ministry of Industries
91, Motijheel C/A, Dhaka-1000

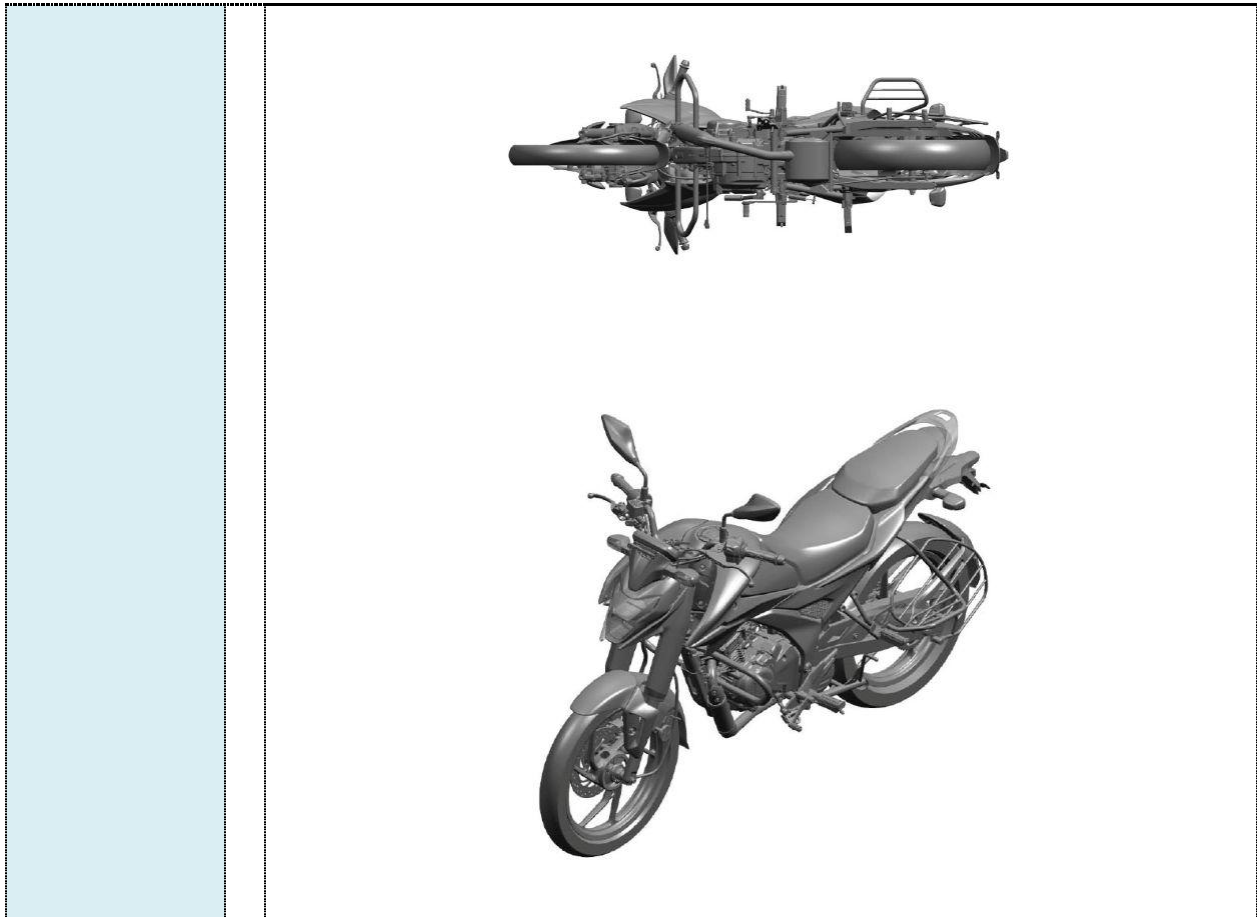



Government of the People's Republic of Bangladesh
 Department of Patents, Industrial Designs & Trademarks
 Ministry of Industries
 91, Motijheel C/A, Dhaka-1000



"Published before acceptance under section 10(1) Proviso"

Application number	: BD-D-2025-148
Title	: Toy hajak light manufactured by Nasir Plastic
Date	: 13/03/2025
Class	: 21-01
Owner & Address	: Md. Nasir, Proprietor, Nasir Plastic 56/7, Islambagh, Bangladesh
Service Address	: Md. Nasir, Proprietor, Nasir Plastic
Priority	: N/A
Representation	: 



Government of the People's Republic of Bangladesh
 Department of Patents, Industrial Designs & Trademarks
 Ministry of Industries
 91, Motijheel C/A, Dhaka-1000



"Published before acceptance under section 10(1) Proviso"

Application number	: BD-D-2025-149
Title	: Toy house manufactured by Mokter Toys
Date	: 13/03/2025
Class	: 21-01
Owner & Address	: Md. Mokter, Proprietor, Mokter Toys 76/77/2, Water Works Road, Bangladesh
Service Address	: Md. Mokter, Proprietor, Mokter Toys
Priority	: N/A
Representation	: 



Government of the People's Republic of Bangladesh
 Department of Patents, Industrial Designs & Trademarks
 Ministry of Industries
 91, Motijheel C/A, Dhaka-1000



"Published before acceptance under section 10(1) Proviso"

Application number	: BD-D-2025-150
Title	: Toy doll set manufactured by Aman Toy Garden
Date	: 13/03/2025
Class	: 21-01
Owner & Address	: Md. Aman Ullah, Proprietor, Aman Toy Garden BSCIC Industrial Area, Plot-A/24, Ruhitpur, Keraniganj, Bangladesh
Service Address	: Md. Aman Ullah, Proprietor, Aman Toy Garden
Priority	: N/A
Representation	: 



Government of the People's Republic of Bangladesh
 Department of Patents, Industrial Designs & Trademarks
 Ministry of Industries
 91, Motijheel C/A, Dhaka-1000



"Published before acceptance under section 10(1) Proviso"

Application number	: BD-D-2025-154
Title	: Toy slider manufactured by Aman Toy Garden
Date	: 16/03/2025
Class	: 21-01
Owner & Address	: Md. Aman Ullah, Proprietor, Aman Toy Garden BSCIC Industrial Area, Plot-A-24, Ruhitpur, Keraniganj Model, Bangladesh
Service Address	: Md. Aman Ullah, Proprietor, Aman Toy Garden
Priority	: N/A
Representation	: 



Government of the People's Republic of Bangladesh
 Department of Patents, Industrial Designs & Trademarks
 Ministry of Industries
 91, Motijheel C/A, Dhaka-1000



"Published before acceptance under section 10(1) Proviso"

Application number	: BD-D-2025-171
Title	: "Face Mask" made of cotton manufactured and marketed by M/s. Fatema Enterprise
Date	: 24/03/2025
Class	: 02-99
Owner & Address	: Md. Ramjan Mollah M/s. Fatema Enterprise Reza Market, Shop No. 02, 5 No. Committeegonj, Babu bazar, Bangladesh
Service Address	: Md. Ramjan Mollah M/s. Fatema Enterprise
Priority	: N/A
Representation	: 



Government of the People's Republic of Bangladesh
 Department of Patents, Industrial Designs & Trademarks
 Ministry of Industries
 91, Motijheel C/A, Dhaka-1000



"Published before acceptance under section 10(1) Proviso"

Application number	: BD-D-2025-172
Title	: "Face Mask" made of cotton manufactured and marketed by M/s. Fatema Enterprise
Date	: 24/03/2025
Class	: 02-99
Owner & Address	: Md. Ramjan Mollah M/s. Fatema Enterprise Reza Market, Shop No. 02, 5 No. Committeegonj, Babu bazar, Bangladesh
Service Address	: Md. Ramjan Mollah M/s. Fatema Enterprise
Priority	: N/A
Representation	: 



Government of the People's Republic of Bangladesh
 Department of Patents, Industrial Designs & Trademarks
 Ministry of Industries
 91, Motijheel C/A, Dhaka-1000



"Published before acceptance under section 10(1) Proviso"

Application number	: BD-D-2025-173
Title	: "Face Mask" made of cotton manufactured and marketed by M/s. Fatema Enterprise
Date	: 24/03/2025
Class	: 02-99
Owner & Address	: Md. Ramjan Mollah M/s. Fatema Enterprise Reza Market, Shop No. 02, 5 No. Committeegonj, Babu bazar, Bangladesh
Service Address	: Md. Ramjan Mollah M/s. Fatema Enterprise
Priority	: N/A
Representation	: 



Government of the People's Republic of Bangladesh
 Department of Patents, Industrial Designs & Trademarks
 Ministry of Industries
 91, Motijheel C/A, Dhaka-1000



"Published before acceptance under section 10(1) Proviso"

Application number	: BD-D-2025-174
Title	: "Face Mask" made of cotton manufactured and marketed by M/s. Fatema Enterprise
Date	: 24/03/2025
Class	: 02-99
Owner & Address	: Md. Ramjan Mollah M/s. Fatema Enterprise Reza Market, Shop No. 02, 5 No. Committeegonj, Babu bazar, Bangladesh
Service Address	: Md. Ramjan Mollah M/s. Fatema Enterprise
Priority	: N/A
Representation	: 



Government of the People's Republic of Bangladesh
 Department of Patents, Industrial Designs & Trademarks
 Ministry of Industries
 91, Motijheel C/A, Dhaka-1000



"Published before acceptance under section 10(1) Proviso"

Application number	: BD-D-2025-175
Title	: "Face Mask" made of cotton manufactured and marketed by M/s. Fatema Enterprise
Date	: 24/03/2025
Class	: 02-99
Owner & Address	: Md. Ramjan Mollah M/s. Fatema Enterprise Reza Market, Shop No. 02, 5 No. Committeegonj, Babu bazar, Bangladesh
Service Address	: Md. Ramjan Mollah M/s. Fatema Enterprise
Priority	: N/A
Representation	: 



Government of the People's Republic of Bangladesh
 Department of Patents, Industrial Designs & Trademarks
 Ministry of Industries
 91, Motijheel C/A, Dhaka-1000



"Published before acceptance under section 10(1) Proviso"

Application number	: BD-D-2025-176
Title	: "Face Mask" made of cotton manufactured and marketed by M/s. Fatema Enterprise
Date	: 24/03/2025
Class	: 02-99
Owner & Address	: Md. Ramjan Mollah M/s. Fatema Enterprise Reza Market, Shop No. 02, 5 No. Committeegonj, Babu bazar, Bangladesh
Service Address	: Md. Ramjan Mollah M/s. Fatema Enterprise
Priority	: N/A
Representation	: 



Government of the People's Republic of Bangladesh
 Department of Patents, Industrial Designs & Trademarks
 Ministry of Industries
 91, Motijheel C/A, Dhaka-1000

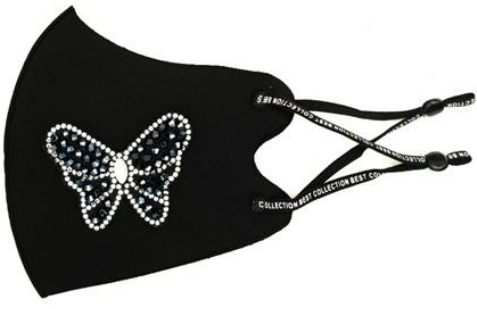

"Published before acceptance under section 10(1) Proviso"

Application number	: BD-D-2025-177
Title	: "Face Mask" made of cotton manufactured and marketed by M/s. Fatema Enterprise
Date	: 24/03/2025
Class	: 02-99
Owner & Address	: Md. Ramjan Mollah M/s. Fatema Enterprise Reza Market, Shop No. 02, 5 No. Committeegonj, Babu bazar, Bangladesh
Service Address	: Md. Ramjan Mollah M/s. Fatema Enterprise
Priority	: N/A
Representation	: 



Government of the People's Republic of Bangladesh
 Department of Patents, Industrial Designs & Trademarks
 Ministry of Industries
 91, Motijheel C/A, Dhaka-1000



"Published before acceptance under section 10(1) Proviso"

Application number	: BD-D-2025-178
Title	: "Face Mask" made of cotton manufactured and marketed by M/s. Fatema Enterprise
Date	: 24/03/2025
Class	: 02-99
Owner & Address	: Md. Ramjan Mollah M/s. Fatema Enterprise Reza Market, Shop No. 02, 5 No. Committeegonj, Babu bazar, Bangladesh
Service Address	: Md. Ramjan Mollah M/s. Fatema Enterprise
Priority	: N/A
Representation	: 



Government of the People's Republic of Bangladesh
 Department of Patents, Industrial Designs & Trademarks
 Ministry of Industries
 91, Motijheel C/A, Dhaka-1000



"Published before acceptance under section 10(1) Proviso"

Application number	: BD-D-2025-179
Title	: "Face Mask" made of cotton manufactured and marketed by M/s. Fatema Enterprise
Date	: 24/03/2025
Class	: 02-99
Owner & Address	: Md. Ramjan Mollah M/s. Fatema Enterprise Reza Market, Shop No. 02, 5 No. Committeegonj, Babu bazar, Bangladesh
Service Address	: Md. Ramjan Mollah M/s. Fatema Enterprise
Priority	: N/A
Representation	: 



Government of the People's Republic of Bangladesh
 Department of Patents, Industrial Designs & Trademarks
 Ministry of Industries
 91, Motijheel C/A, Dhaka-1000



"Published before acceptance under section 10(1) Proviso"

Application number	: BD-D-2025-180
Title	: "Face Mask" made of cotton manufactured and marketed by M/s. Fatema Enterprise
Date	: 24/03/2025
Class	: 02-99
Owner & Address	: Md. Ramjan Mollah M/s. Fatema Enterprise Reza Market, Shop No. 02, 5 No. Committeegonj, Babu bazar, Bangladesh
Service Address	: Md. Ramjan Mollah M/s. Fatema Enterprise
Priority	: N/A
Representation	: 



Government of the People's Republic of Bangladesh
 Department of Patents, Industrial Designs & Trademarks
 Ministry of Industries
 91, Motijheel C/A, Dhaka-1000



"Published before acceptance under section 10(1) Proviso"

Application number	: BD-D-2025-185
Title	: Toy police racing car manufactured by Zihan Plastic Industries
Date	: 27/03/2025
Class	: 21-01
Owner & Address	: Md. Sumun, Proprietor, Zihan Plastic Industries Atasur, Bramonkitta, Keraniganj Model, Bangladesh
Service Address	: Md. Sumun, Proprietor, Zihan Plastic Industries
Priority	: N/A
Representation	: <div style="text-align: center;"> <p>PERSPECTIVE</p>  <p>TOP</p> </div>

Government of the People's Republic of Bangladesh
Department of Patents, Industrial Designs & Trademarks
Ministry of Industries
91, Motijheel C/A, Dhaka-1000





Government of the People's Republic of Bangladesh
 Department of Patents, Industrial Designs & Trademarks
 Ministry of Industries
 91, Motijheel C/A, Dhaka-1000



"Published before acceptance under section 10(1) Proviso"

Application number	: BD-D-2025-190
Title	: Sticker of label for packet of food stuff (BOXES, CASES, CONTAINERS, TIN CANS) which will be used for preserving Noddles manufactured by AKC (Pvt.) Limited.
Date	: 07/04/2025
Class	: 09-03
Owner & Address	: AKC (Pvt.) Limited PRAN-RFL Centre, 105 Middle Badda, GPO BOX# 83, Dhaka-1212, Bangladesh
Service Address	: Md. Masum Rahman
Priority	: N/A
Representation	: 



Government of the People's Republic of Bangladesh
 Department of Patents, Industrial Designs & Trademarks
 Ministry of Industries
 91, Motijheel C/A, Dhaka-1000

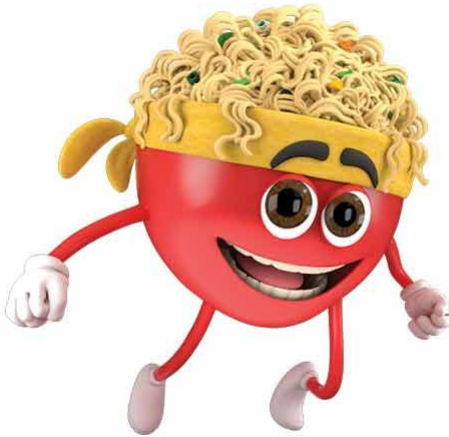

"Published before acceptance under section 10(1) Proviso"

Application number	: BD-D-2025-191
Title	: Sticker of label for packet of food stuff (BOXES, CASES, CONTAINERS, TIN CANS) which will be used for preserving Noddles manufactured by AKC (Pvt.) Limited.
Date	: 07/04/2025
Class	: 09-03
Owner & Address	: AKC (Pvt.) Limited PRAN-RFL Centre, 105 Middle Badda, GPO BOX# 83, Dhaka-1212, Bangladesh
Service Address	: Md. Masum Rahman
Priority	: N/A
Representation	: 



Government of the People's Republic of Bangladesh
 Department of Patents, Industrial Designs & Trademarks
 Ministry of Industries
 91, Motijheel C/A, Dhaka-1000



"Published before acceptance under section 10(1) Proviso"

Application number	: BD-D-2025-193
Title	: Packet of food stuff (BOXES, CASES, CONTAINERS, TIN CANS) which will be used for preserving Noddles manufactured by AKC (Pvt.) Limited
Date	: 07/04/2025
Class	: 09-03
Owner & Address	: AKC (Pvt.) Limited PRAN-RFL Centre, 105 Middle Badda, GPO BOX# 83, Dhaka-1212, Bangladesh
Service Address	: Md. Masum Rahman
Priority	: N/A
Representation	: 



Government of the People's Republic of Bangladesh
 Department of Patents, Industrial Designs & Trademarks
 Ministry of Industries
 91, Motijheel C/A, Dhaka-1000



"Published before acceptance under section 10(1) Proviso"

Application number	: BD-D-2025-194
Title	: Packet of food stuff (BOXES, CASES, CONTAINERS, TIN CANS) which will be used for preserving Noodles manufactured by AKC (Pvt.) Limited
Date	: 07/04/2025
Class	: 09-03
Owner & Address	: AKC (Pvt.) Limited PRAN-RFL Centre, 105 Middle Badda, GPO BOX# 83, Dhaka-1212, Bangladesh
Service Address	: Md. Masum Rahman
Priority	: N/A
Representation	: 



Government of the People's Republic of Bangladesh
 Department of Patents, Industrial Designs & Trademarks
 Ministry of Industries
 91, Motijheel C/A, Dhaka-1000



"Published before acceptance under section 10(1) Proviso"

Application number	: BD-D-2025-195
Title	: Packet of food stuff (BOXES, CASES, CONTAINERS, TIN CANS) which will be used for preserving Noddles manufactured by AKC (Pvt.) Limited.
Date	: 07/04/2025
Class	: 09-03
Owner & Address	: AKC (Pvt.) Limited PRAN-RFL Centre, 105 Middle Badda, GPO BOX# 83, Dhaka-1212, Bangladesh
Service Address	: Md. Masum Rahman
Priority	: N/A
Representation	: 



Government of the People's Republic of Bangladesh
 Department of Patents, Industrial Designs & Trademarks
 Ministry of Industries
 91, Motijheel C/A, Dhaka-1000



"Published before acceptance under section 10(1) Proviso"

Application number	: BD-D-2025-196
Title	: Sticker of label for packet of food stuff (BOXES, CASES, CONTAINERS, TIN CANS) which will be used for preserving Noddles manufactured by AKC (Pvt.) Limited.
Date	: 07/04/2025
Class	: 09-03
Owner & Address	: AKC (Pvt.) Limited PRAN-RFL Centre, 105 Middle Badda, GPO BOX# 83, Dhaka-1212, Bangladesh
Service Address	: Md. Masum Rahman
Priority	: N/A
Representation	:



Government of the People's Republic of Bangladesh
 Department of Patents, Industrial Designs & Trademarks
 Ministry of Industries
 91, Motijheel C/A, Dhaka-1000



"Published before acceptance under section 10(1) Proviso"

Application number	: BD-D-2025-197
Title	: Label for Bottles which will be used for Covering Cold drinks bottles manufactured by AKC (Pvt.) Limited.
Date	: 07/04/2025
Class	: 09-03
Owner & Address	: AKC (Pvt.) Limited PRAN-RFL Centre, 105 Middle Badda, GPO BOX# 83, Dhaka-1212, Bangladesh
Service Address	: Md. Masum Rahman
Priority	: N/A
Representation	: 



Government of the People's Republic of Bangladesh
 Department of Patents, Industrial Designs & Trademarks
 Ministry of Industries
 91, Motijheel C/A, Dhaka-1000



"Published before acceptance under section 10(1) Proviso"

Application number	: BD-D-2025-198
Title	: Bottles which will be used for preserving Cold drinks manufactured by AKC (Pvt.) Limited.
Date	: 07/04/2025
Class	: 09-01
Owner & Address	: AKC (Pvt.) Limited PRAN-RFL Centre, 105 Middle Badda, GPO BOX# 83, Dhaka-1212, Bangladesh
Service Address	: Md. Masum Rahman
Priority	: N/A
Representation	: 



Government of the People's Republic of Bangladesh
 Department of Patents, Industrial Designs & Trademarks
 Ministry of Industries
 91, Motijheel C/A, Dhaka-1000



"Published before acceptance under section 10(1) Proviso"

Application number	: BD-D-2025-214
Title	: Toy panda set manufactured by Zihan Plastic Industries
Date	: 20/04/2025
Class	: 21-01
Owner & Address	: Md. Sumun, Proprietor Zihan Plastic Industries Atasur, Bramonkitta, Keraniganj Model,, Bangladesh
Service Address	: Md. Sumun, Proprietor Zihan Plastic Industries
Priority	: N/A
Representation	: 



Government of the People's Republic of Bangladesh
 Department of Patents, Industrial Designs & Trademarks
 Ministry of Industries
 91, Motijheel C/A, Dhaka-1000



"Published before acceptance under section 10(1) Proviso"

Application number	: BD-D-2025-215
Title	: Toy car set manufactured by Aman Toy Garden
Date	: 20/04/2025
Class	: 21-01
Owner & Address	: Md. Aman Ullah, Proprietor Aman Toy Garden BSCIC Industrial Area, Plot No. A-24, Ruhitpur, Keraniganj Model, Bangladesh
Service Address	: Md. Aman Ullah, Proprietor Aman Toy Garden
Priority	: N/A
Representation	: 



Government of the People's Republic of Bangladesh
 Department of Patents, Industrial Designs & Trademarks
 Ministry of Industries
 91, Motijheel C/A, Dhaka-1000



"Published before acceptance under section 10(1) Proviso"

Application number	: BD-D-2025-216
Title	: Toy remote control tank manufactured by Aman Toy Garden
Date	: 20/04/2025
Class	: 21-01
Owner & Address	: Md. Aman Ullah, Proprietor Aman Toy Garden BSCIC Industrial Area, Plot No. A-24, Ruhitpur, Keraniganj Model, Bangladesh
Service Address	: Md. Aman Ullah, Proprietor Aman Toy Garden
Priority	: N/A
Representation	: 



Government of the People's Republic of Bangladesh
 Department of Patents, Industrial Designs & Trademarks
 Ministry of Industries
 91, Motijheel C/A, Dhaka-1000



"Published before acceptance under section 10(1) Proviso"

Application number	: BD-D-2025-218
Title	: Toy remote control flying eagle manufactured by Aman Toy Garden
Date	: 20/04/2025
Class	: 21-01
Owner & Address	: Md. Aman Ullah, Proprietor Aman Toy Garden BSCIC Industrial Area, Plot No. A-24, Ruhitpur, Keraniganj Model, Bangladesh
Service Address	: Md. Aman Ullah, Proprietor Aman Toy Garden
Priority	: N/A
Representation	: 



Government of the People's Republic of Bangladesh
 Department of Patents, Industrial Designs & Trademarks
 Ministry of Industries
 91, Motijheel C/A, Dhaka-1000



"Published before acceptance under section 10(1) Proviso"

Application number	: BD-D-2025-219
Title	: Toy remote control range rover car manufactured by Tajul Plastic Toy Industries
Date	: 20/04/2025
Class	: 21-01
Owner & Address	: Sirajul Islam (Tajul), Proprietor Tajul Plastic Toy Industries Atasur, Brahmonkitta, Bangladesh
Service Address	: Sirajul Islam (Tajul), Proprietor Tajul Plastic Toy Industries
Priority	: N/A
Representation	: 



Government of the People's Republic of Bangladesh
 Department of Patents, Industrial Designs & Trademarks
 Ministry of Industries
 91, Motijheel C/A, Dhaka-1000



"Published before acceptance under section 10(1) Proviso"

Application number	: BD-D-2025-220
Title	: Melamine Plate manufactured by Diamond Melamineware Industries Ltd
Date	: 20/04/2025
Class	: 07-01
Owner & Address	: DIAMOND MELAMINEWARE INDUSTRIES LTD 1/1 Sakta, Keranigonj Model, Bangladesh
Service Address	: Md. Mokter Hossain, Managing Director
Priority	: N/A
Representation	: 



Government of the People's Republic of Bangladesh
 Department of Patents, Industrial Designs & Trademarks
 Ministry of Industries
 91, Motijheel C/A, Dhaka-1000



"Published before acceptance under section 10(1) Proviso"

Application number	: BD-D-2025-221
Title	: Melamine Plate manufactured by Diamond Melamineware Industries Ltd
Date	: 20/04/2025
Class	: 07-01
Owner & Address	: DIAMOND MELAMINEWARE INDUSTRIES LTD 1/1 Sakta, Keranigonj Model, Bangladesh
Service Address	: Md. Mokter Hossain, Managing Director
Priority	: N/A
Representation	: 



Government of the People’s Republic of Bangladesh
 Department of Patents, Industrial Designs & Trademarks
 Ministry of Industries
 91, Motijheel C/A, Dhaka-1000

"Published before acceptance under section 10(1) Proviso"

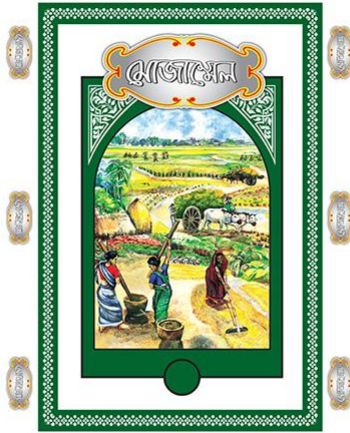
Application number	: BD-D-2025-250
Title	: the MOZAMMEL ChiniguraAromatic Rice Packet
Date	: 08/05/2025
Class	: 09-03
Owner & Address	: Md. Motiur Rahma M RAHMAN AUTO RICE MILLS Jamtola, Amnura Road, Chapainawabganj Sadar, Chapainawabganj, Bangladesh; , Dhaka Office: Probal Tower, Flat No. 8E, 45, Probal Housing, Ring Road, Mohammadpur, Adabor,, Bangladesh
Service Address	: MOHIUL ISLAM
Priority	: N/A
Representation	: 



Government of the People's Republic of Bangladesh
 Department of Patents, Industrial Designs & Trademarks
 Ministry of Industries
 91, Motijheel C/A, Dhaka-1000



"Published before acceptance under section 10(1) Proviso"

Application number	: BD-D-2025-253
Title	: Packet (BOXES, CASES, CONTAINERS, (PRESERVE) TINS OR CANS) which will be used for Preserving Candy manufactured by AKC (Pvt.) Limited.
Date	: 12/05/2025
Class	: 09-03
Owner & Address	: AKC (Pvt.) Limited PRAN-RFL Centre, 105 Middle Badda, GPO BOX# 83, Dhaka-1212, Bangladesh
Service Address	: Md. Masum Rahman
Priority	: N/A
Representation	: 



Government of the People's Republic of Bangladesh
 Department of Patents, Industrial Designs & Trademarks
 Ministry of Industries
 91, Motijheel C/A, Dhaka-1000



"Published before acceptance under section 10(1) Proviso"

Application number	: BD-D-2025-254
Title	: Packet (BOXES, CASES, CONTAINERS, (PRESERVE) TINS OR CANS) which will be used for Preserving Chutney manufactured by AKC (Pvt.) Limited.
Date	: 12/05/2025
Class	: 09-03
Owner & Address	: AKC (Pvt.) Limited PRAN-RFL Centre, 105 Middle Badda, GPO BOX# 83, Dhaka-1212, Bangladesh
Service Address	: Md. Masum Rahman
Priority	: N/A
Representation	: 



Government of the People's Republic of Bangladesh
 Department of Patents, Industrial Designs & Trademarks
 Ministry of Industries
 91, Motijheel C/A, Dhaka-1000



"Published before acceptance under section 10(1) Proviso"

Application number	: BD-D-2025-255
Title	: Packet (BOXES, CASES, CONTAINERS, (PRESERVE) TINS OR CANS) which will be used for Preserving Chutney manufactured by AKC (Pvt.) Limited.
Date	: 12/05/2025
Class	: 09-03
Owner & Address	: AKC (Pvt.) Limited PRAN-RFL Centre, 105 Middle Badda, GPO BOX# 83, Dhaka-1212, Bangladesh
Service Address	: Md. Masum Rahman
Priority	: N/A
Representation	: 



Government of the People's Republic of Bangladesh
 Department of Patents, Industrial Designs & Trademarks
 Ministry of Industries
 91, Motijheel C/A, Dhaka-1000



"Published before acceptance under section 10(1) Proviso"

Application number	: BD-D-2025-256
Title	: Packet (BOXES, CASES, CONTAINERS, (PRESERVE) TINS OR CANS) which will be used for Preserving Chutney manufactured by AKC (Pvt.) Limited.
Date	: 12/05/2025
Class	: 09-03
Owner & Address	: AKC (Pvt.) Limited PRAN-RFL Centre, 105 Middle Badda, GPO BOX# 83, Dhaka-1212, Bangladesh
Service Address	: Md. Masum Rahman
Priority	: N/A
Representation	: 



Government of the People's Republic of Bangladesh
 Department of Patents, Industrial Designs & Trademarks
 Ministry of Industries
 91, Motijheel C/A, Dhaka-1000



"Published before acceptance under section 10(1) Proviso"

Application number	: BD-D-2025-257
Title	: Packet (BOXES, CASES, CONTAINERS, (PRESERVE) TINS OR CANS) which will be used for Preserving Chutney manufactured by AKC (Pvt.) Limited.
Date	: 12/05/2025
Class	: 09-03
Owner & Address	: AKC (Pvt.) Limited PRAN-RFL Centre, 105 Middle Badda, GPO BOX# 83, Dhaka-1212, Bangladesh
Service Address	: Md. Masum Rahman
Priority	: N/A
Representation	: 



Government of the People's Republic of Bangladesh
 Department of Patents, Industrial Designs & Trademarks
 Ministry of Industries
 91, Motijheel C/A, Dhaka-1000



"Published before acceptance under section 10(1) Proviso"

Application number	: BD-D-2025-258
Title	: Packet (BOXES, CASES, CONTAINERS, (PRESERVE) TINS OR CANS) which will be used for Preserving Chutney manufactured by AKC (Pvt.) Limited.
Date	: 12/05/2025
Class	: 09-03
Owner & Address	: AKC (Pvt.) Limited PRAN-RFL Centre, 105 Middle Badda, GPO BOX# 83, Dhaka-1212, Bangladesh
Service Address	: Md. Masum Rahman
Priority	: N/A
Representation	: 



Government of the People's Republic of Bangladesh
 Department of Patents, Industrial Designs & Trademarks
 Ministry of Industries
 91, Motijheel C/A, Dhaka-1000



"Published before acceptance under section 10(1) Proviso"

Application number	: BD-D-2025-259
Title	: Packet (BOXES, CASES, CONTAINERS, (PRESERVE) TINS OR CANS) which will be used for Preserving Chutney manufactured by AKC (Pvt.) Limited.
Date	: 12/05/2025
Class	: 09-03
Owner & Address	: AKC (Pvt.) Limited PRAN-RFL Centre, 105 Middle Badda, GPO BOX# 83, Dhaka-1212, Bangladesh
Service Address	: Md. Masum Rahman
Priority	: N/A
Representation	: <div style="text-align: center;">  </div>



Government of the People's Republic of Bangladesh
 Department of Patents, Industrial Designs & Trademarks
 Ministry of Industries
 91, Motijheel C/A, Dhaka-1000



"Published before acceptance under section 10(1) Proviso"

Application number	: BD-D-2025-260
Title	: Packet (BOXES, CASES, CONTAINERS, (PRESERVE) TINS OR CANS) which will be used for Preserving Chutney manufactured by AKC (Pvt.) Limited.
Date	: 12/05/2025
Class	: 09-03
Owner & Address	: AKC (Pvt.) Limited PRAN-RFL Centre, 105 Middle Badda, GPO BOX# 83, Dhaka-1212, Bangladesh
Service Address	: Md. Masum Rahman
Priority	: N/A
Representation	: 



Government of the People's Republic of Bangladesh
 Department of Patents, Industrial Designs & Trademarks
 Ministry of Industries
 91, Motijheel C/A, Dhaka-1000



"Published before acceptance under section 10(1) Proviso"

Application number	: BD-D-2025-261
Title	: Packet (BOXES, CASES, CONTAINERS, (PRESERVE) TINS OR CANS) which will be used for Preserving Chutney manufactured by AKC (Pvt.) Limited.
Date	: 12/05/2025
Class	: 09-03
Owner & Address	: AKC (Pvt.) Limited PRAN-RFL Centre, 105 Middle Badda, GPO BOX# 83, Dhaka-1212, Bangladesh
Service Address	: Md. Masum Rahman
Priority	: N/A
Representation	: <div style="text-align: center;">  </div>



Government of the People's Republic of Bangladesh
 Department of Patents, Industrial Designs & Trademarks
 Ministry of Industries
 91, Motijheel C/A, Dhaka-1000



"Published before acceptance under section 10(1) Proviso"

Application number	: BD-D-2025-262
Title	: Packet (BOXES, CASES, CONTAINERS, (PRESERVE) TINS OR CANS) which will be used for Preserving Chutney manufactured by AKC (Pvt.) Limited.
Date	: 12/05/2025
Class	: 09-03
Owner & Address	: AKC (Pvt.) Limited PRAN-RFL Centre, 105 Middle Badda, GPO BOX# 83, Dhaka-1212, Bangladesh
Service Address	: Md. Masum Rahman
Priority	: N/A
Representation	: 



Government of the People's Republic of Bangladesh
 Department of Patents, Industrial Designs & Trademarks
 Ministry of Industries
 91, Motijheel C/A, Dhaka-1000



"Published before acceptance under section 10(1) Proviso"

Application number	: BD-D-2025-264
Title	: BOTTLE (BOTTLES, FLASKS, POTS, CARBOYS, DEMIJOHNS, AND CONTAINERS WITH DYNAMIC DISPENSING MEANS) which will be used for Preserving Chutney manufactured by AKC (Pvt.) Limited.
Date	: 12/05/2025
Class	: 09-01
Owner & Address	: AKC (Pvt.) Limited PRAN-RFL Centre, 105 Middle Badda, GPO BOX# 83, Dhaka-1212, Bangladesh
Service Address	: Md. Masum Rahman
Priority	: N/A
Representation	: 



Government of the People's Republic of Bangladesh
 Department of Patents, Industrial Designs & Trademarks
 Ministry of Industries
 91, Motijheel C/A, Dhaka-1000



"Published before acceptance under section 10(1) Proviso"

Application number	: BD-D-2025-265
Title	: Packet (BOXES, CASES, CONTAINERS, (PRESERVE) TINS OR CANS) which will be used for Preserving Chutney manufactured by AKC (Pvt.) Limited.
Date	: 12/05/2025
Class	: 09-03
Owner & Address	: AKC (Pvt.) Limited PRAN-RFL Centre, 105 Middle Badda, GPO BOX# 83, Dhaka-1212, Bangladesh
Service Address	: Md. Masum Rahman
Priority	: N/A
Representation	: 



Government of the People's Republic of Bangladesh
 Department of Patents, Industrial Designs & Trademarks
 Ministry of Industries
 91, Motijheel C/A, Dhaka-1000



"Published before acceptance under section 10(1) Proviso"

Application number	: BD-D-2025-266
Title	: BOTTLES (BOTTLES, FLASKS, POTS, CARBOYS, DEMIJOHNS, AND CONTAINERS WITH DYNAMIC DISPENSING MEANS) which will be used for Preserving Chutney manufactured by AKC (Pvt.) Limited.
Date	: 12/05/2025
Class	: 09-01
Owner & Address	: AKC (Pvt.) Limited PRAN-RFL Centre, 105 Middle Badda, GPO BOX# 83, Dhaka-1212, Bangladesh
Service Address	: Md. Masum Rahman
Priority	: N/A
Representation	: 



Government of the People’s Republic of Bangladesh
 Department of Patents, Industrial Designs & Trademarks
 Ministry of Industries
 91, Motijheel C/A, Dhaka-1000

"Published before acceptance under section 10(1) Proviso"

Application number	: BD-D-2025-267
Title	: Packet (BOXES, CASES, CONTAINERS, (PRESERVE) TINS OR CANS) which will be used for preserving cement manufactured by Shun shing Trading Limited.
Date	: 12/05/2025
Class	: 09-03
Owner & Address	: Shun shing Trading Limited Room 1913-16, 19th floor, China Merchants Tower, Shun Tak Center, Hong Kong
Service Address	: Md. Masum Rahman
Priority	: N/A
Representation	:



Government of the People’s Republic of Bangladesh
 Department of Patents, Industrial Designs & Trademarks
 Ministry of Industries
 91, Motijheel C/A, Dhaka-1000

"Published before acceptance under section 10(1) Proviso"

Application number	: BD-D-2025-268
Title	: Packet (BOXES, CASES, CONTAINERS, (PRESERVE) TINS OR CANS) which will be used for preserving cement manufactured by Shun shing Trading Limited.
Date	: 12/05/2025
Class	: 09-03
Owner & Address	: Shun shing Trading Limited Room 1913-16, 19th floor, China Merchants Tower, Shun Tak Center, Hong Kong
Service Address	: Md. Masum Rahman
Priority	: N/A
Representation	: 



Government of the People’s Republic of Bangladesh
 Department of Patents, Industrial Designs & Trademarks
 Ministry of Industries
 91, Motijheel C/A, Dhaka-1000

"Published before acceptance under section 10(1) Proviso"

Application number	: BD-D-2025-269
Title	: Packet (BOXES, CASES, CONTAINERS, (PRESERVE) TINS OR CANS) which will be used for preserving cement manufactured by Shun shing Trading Limited.
Date	: 12/05/2025
Class	: 09-03
Owner & Address	: Shun shing Trading Limited Room 1913-16, 19th floor, China Merchants Tower, Shun Tak Center, Hong Kong
Service Address	: Md. Masum Rahman
Priority	: N/A
Representation	: 



Government of the People’s Republic of Bangladesh
 Department of Patents, Industrial Designs & Trademarks
 Ministry of Industries
 91, Motijheel C/A, Dhaka-1000

"Published before acceptance under section 10(1) Proviso"

Application number	: BD-D-2025-270
Title	: Packet (BOXES, CASES, CONTAINERS, (PRESERVE) TINS OR CANS) which will be used for preserving cement manufactured by Shun shing Trading Limited.
Date	: 12/05/2025
Class	: 09-03
Owner & Address	: Shun shing Trading Limited Room 1913-16, 19th floor, China Merchants Tower, Shun Tak Center, Hong Kong
Service Address	: Md. Masum Rahman
Priority	: N/A
Representation	: 



Government of the People’s Republic of Bangladesh
 Department of Patents, Industrial Designs & Trademarks
 Ministry of Industries
 91, Motijheel C/A, Dhaka-1000

"Published before acceptance under section 10(1) Proviso"

Application number	: BD-D-2025-271
Title	: Packet (BOXES, CASES, CONTAINERS, (PRESERVE) TINS OR CANS) which will be used for preserving cement manufactured by Shun shing Trading Limited.
Date	: 12/05/2025
Class	: 09-03
Owner & Address	: Shun shing Trading Limited Room 1913-16, 19th floor, China Merchants Tower, Shun Tak Center, Hong Kong
Service Address	: Md. Masum Rahman
Priority	: N/A
Representation	: 



Government of the People's Republic of Bangladesh
 Department of Patents, Industrial Designs & Trademarks
 Ministry of Industries
 91, Motijheel C/A, Dhaka-1000

"Published before acceptance under section 10(1) Proviso"

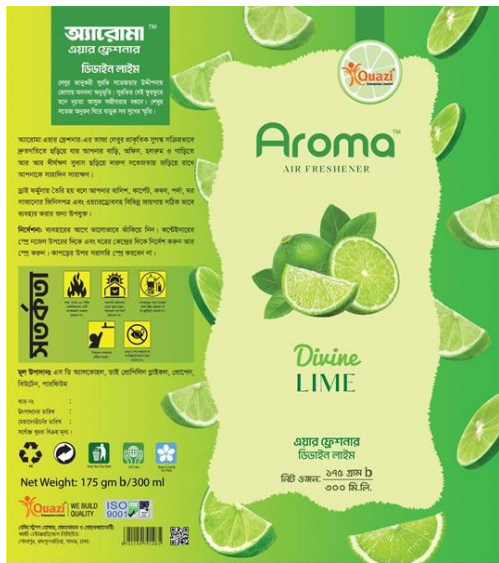
Application number	: BD-D-2025-273
Title	: label (BOXES, CASES, CONTAINERS, (PRESERVE) TINS OR CANS) which will be used for covering Air Freshener Bottle manufactured by Quazi Enterprises Limited.
Date	: 13/05/2025
Class	: 09-03
Owner & Address	: Quazi Enterprises Limited Head Office: B-52, Kemal Ataturk Avenue, Banani, Dhaka-1213 factory address Shovapur, Rajfulbaria, Savar, Bangladesh
Service Address	: Md. Masum Rahman
Priority	: N/A
Representation	: 



Government of the People’s Republic of Bangladesh
 Department of Patents, Industrial Designs & Trademarks
 Ministry of Industries
 91, Motijheel C/A, Dhaka-1000

"Published before acceptance under section 10(1) Proviso"

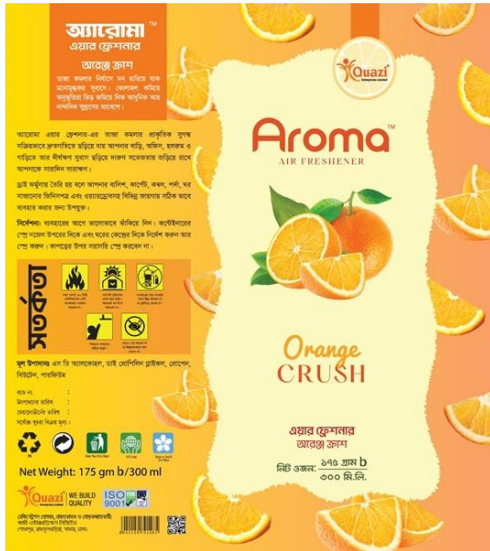
Application number	: BD-D-2025-274
Title	: label (BOXES, CASES, CONTAINERS, (PRESERVE) TINS OR CANS) which will be used for covering Air Freshener Bottle manufactured by Quazi Enterprises Limited.
Date	: 13/05/2025
Class	: 09-03
Owner & Address	: Quazi Enterprises Limited Head Office: B-52, Kemal Ataturk Avenue, Banani, Dhaka-1213 factory address Shovapur, Rajfulbaria, Savar, Bangladesh
Service Address	: Md. Masum Rahman
Priority	: N/A
Representation	: 



Government of the People’s Republic of Bangladesh
 Department of Patents, Industrial Designs & Trademarks
 Ministry of Industries
 91, Motijheel C/A, Dhaka-1000

"Published before acceptance under section 10(1) Proviso"

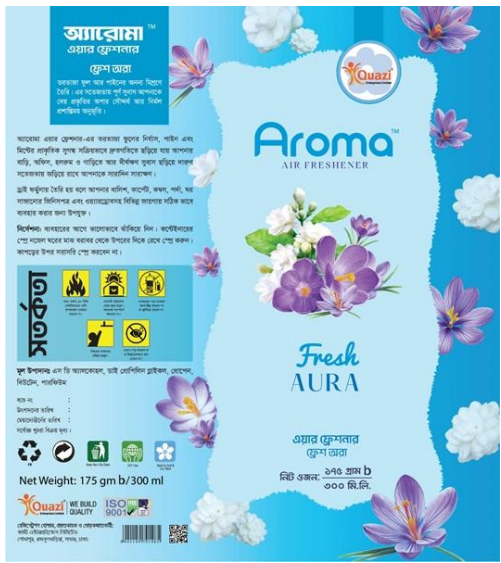
Application number	: BD-D-2025-276
Title	: label (BOXES, CASES, CONTAINERS, (PRESERVE) TINS OR CANS) which will be used for covering Air Freshener Bottle manufactured by Quazi Enterprises Limited.
Date	: 13/05/2025
Class	: 09-03
Owner & Address	: Quazi Enterprises Limited Head Office: B-52, Kemal Ataturk Avenue, Banani, Dhaka-1213 factory address Shovapur, Rajfulbaria, Savar, Bangladesh
Service Address	: Md. Masum Rahman
Priority	: N/A
Representation	: 



Government of the People’s Republic of Bangladesh
 Department of Patents, Industrial Designs & Trademarks
 Ministry of Industries
 91, Motijheel C/A, Dhaka-1000

"Published before acceptance under section 10(1) Proviso"

Application number	: BD-D-2025-278
Title	: Packet (BOXES, CASES, CONTAINERS, TIN CANS, AND PRESSURIZED CONTAINERS) which will be used for preserving Toothpaste manufactured by Dabur India Limited
Date	: 14/05/2025
Class	: 09-03
Owner & Address	: Dabur India Limited 8/3, Asaf Ali Road,, India
Service Address	: Md Razib Alam
Priority	: N/A
Representation	: 



Government of the People's Republic of Bangladesh
 Department of Patents, Industrial Designs & Trademarks
 Ministry of Industries
 91, Motijheel C/A, Dhaka-1000



"Published before acceptance under section 10(1) Proviso"

Application number	: BD-D-2025-287
Title	: THREE WHEELED VEHICLE
Date	: 06/06/2025
Class	: 12-11
Owner & Address	: Bajaj Auto Limited Bajaj Auto Limited, Mumbai-Pune Road, India
Service Address	: Motassir 19/D, East Nayatola, Moghbazar, Dhaka, Bangladesh
Priority	: 440701001
Representation	: <div style="text-align: center;"> <p>FRONT</p>  <p>FRONT VIEW</p> <p>FRONT</p> </div>

Government of the People's Republic of Bangladesh
Department of Patents, Industrial Designs & Trademarks
Ministry of Industries
91, Motijheel C/A, Dhaka-1000



RIGHT FRONT PERSPECTIVE VIEW

RIGHT



RIGHT HAND SIDE VIEW

RIGHT



RIGHT REAR PERSPECTIVE VIEW

BACK

Government of the People's Republic of Bangladesh
Department of Patents, Industrial Designs & Trademarks
Ministry of Industries
91, Motijheel C/A, Dhaka-1000

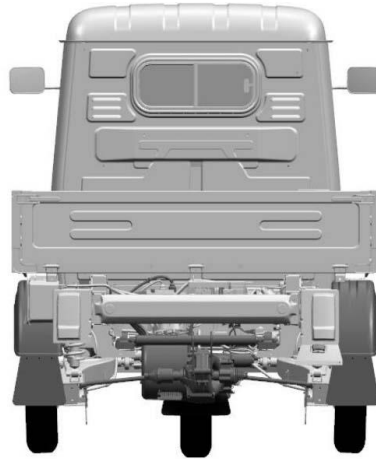

REAR VIEW

BACK



LEFT REAR PERSPECTIVE VIEW

LEFT

Government of the People's Republic of Bangladesh
Department of Patents, Industrial Designs & Trademarks
Ministry of Industries
91, Motijheel C/A, Dhaka-1000



LEFT HAND SIDE VIEW

LEFT



LEFT FRONT PERSPECTIVE VIEW

TOP

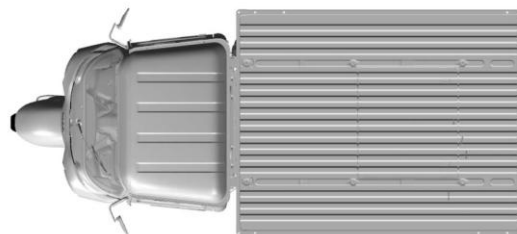

TOP VIEW

BOTTOM

Government of the People's Republic of Bangladesh
Department of Patents, Industrial Designs & Trademarks
Ministry of Industries
91, Motijheel C/A, Dhaka-1000

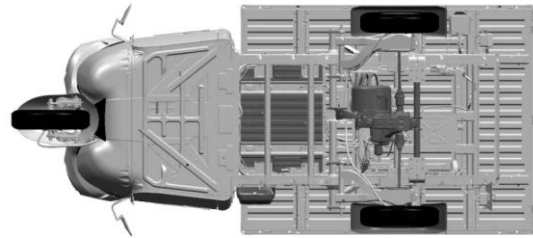

BOTTOM VIEW

PERSPECTIVE



PERSPECTIVE VIEW



Government of the People's Republic of Bangladesh
 Department of Patents, Industrial Designs & Trademarks
 Ministry of Industries
 91, Motijheel C/A, Dhaka-1000



"Published before acceptance under section 10(1) Proviso"

Application number	: BD-D-2025-288
Title	: AUTOMOTIVE VEHICLE
Date	: 07/06/2025
Class	: 12-11
Owner & Address	: Bajaj Auto Limited Bajaj Auto Limited, Mumbai-Pune Road,, India
Service Address	: Motassir 19/D, East Nayatola, Moghbazar, Dhaka, Bangladesh
Priority	: 440542001
Representation	: <div style="text-align: center;"> <p>FRONT</p>  <p>FRONT VIEW</p> <p>FRONT</p> </div>

Government of the People's Republic of Bangladesh
Department of Patents, Industrial Designs & Trademarks
Ministry of Industries
91, Motijheel C/A, Dhaka-1000



RIGHT FRONT PERSPECTIVE VIEW

RIGHT



RIGHT HAND SIDE VIEW

RIGHT



RIGHT REAR PERSPECTIVE VIEW

Government of the People's Republic of Bangladesh
Department of Patents, Industrial Designs & Trademarks
Ministry of Industries
91, Motijheel C/A, Dhaka-1000



Government of the People's Republic of Bangladesh
Department of Patents, Industrial Designs & Trademarks
Ministry of Industries
91, Motijheel C/A, Dhaka-1000



LEFT HAND SIDE VIEW

LEFT



LEFT FRONT PERSPECTIVE VIEW

TOP



TOP VIEW

BOTTOM

Government of the People's Republic of Bangladesh
Department of Patents, Industrial Designs & Trademarks
Ministry of Industries
91, Motijheel C/A, Dhaka-1000

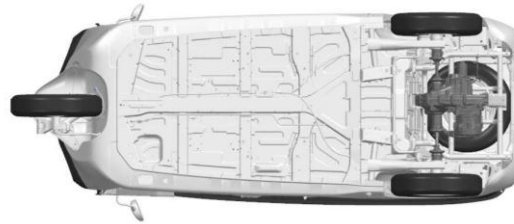

BOTTOM VIEW

PERSPECTIVE

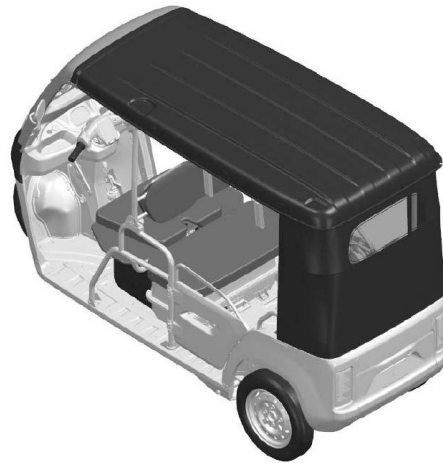

PERSPECTIVE VIEW



Government of the People's Republic of Bangladesh
 Department of Patents, Industrial Designs & Trademarks
 Ministry of Industries
 91, Motijheel C/A, Dhaka-1000

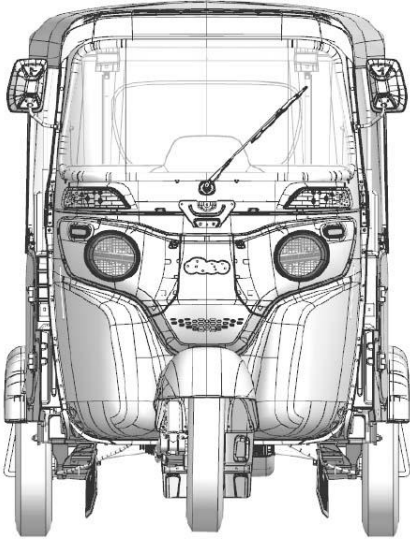

"Published before acceptance under section 10(1) Proviso"

Application number	: BD-D-2025-289
Title	: THREE WHEELED VEHICLE
Date	: 07/06/2025
Class	: 12-11
Owner & Address	: Bajaj Auto Limited Bajaj Auto Limited, Mumbai-Pune Road, India
Service Address	: Motassir 19/D, East Nayatola, Moghbazar, Dhaka, Bangladesh
Priority	: 440750001
Representation	: <div style="text-align: center;"> <p>FRONT</p>  <p>FRONT VIEW</p> <p>FRONT</p> </div>

Government of the People's Republic of Bangladesh
Department of Patents, Industrial Designs & Trademarks
Ministry of Industries
91, Motijheel C/A, Dhaka-1000

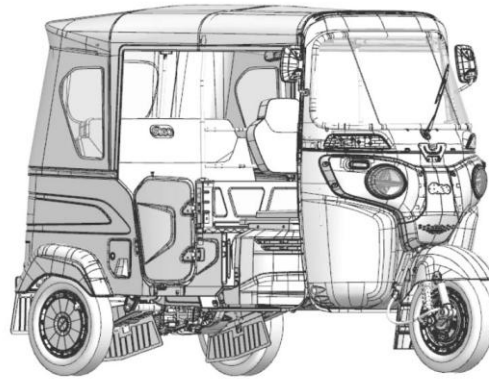

RIGHT FRONT PERSPECTIVE VIEW

RIGHT

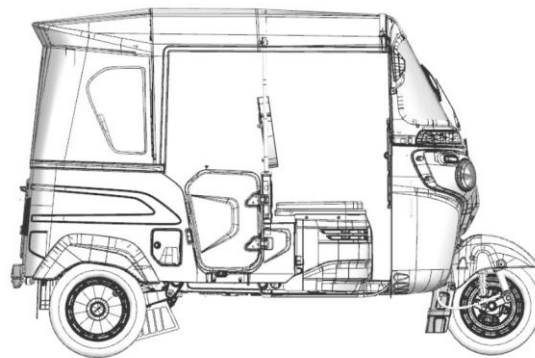

RIGHT HAND SIDE VIEW

RIGHT

Government of the People's Republic of Bangladesh
Department of Patents, Industrial Designs & Trademarks
Ministry of Industries
91, Motijheel C/A, Dhaka-1000

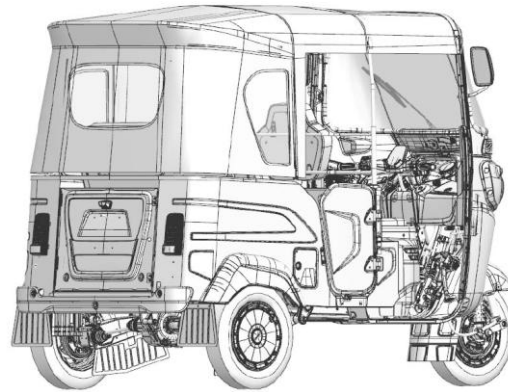

RIGHT REAR PERSPECTIVE VIEW

BACK

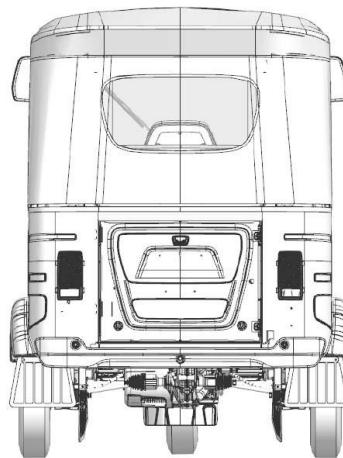

REAR VIEW

BACK

Government of the People's Republic of Bangladesh
Department of Patents, Industrial Designs & Trademarks
Ministry of Industries
91, Motijheel C/A, Dhaka-1000

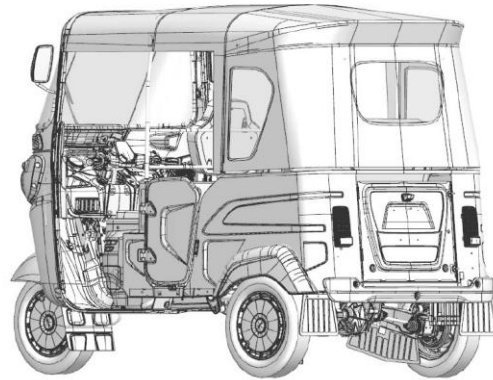

LEFT REAR PERSPECTIVE VIEW

LEFT

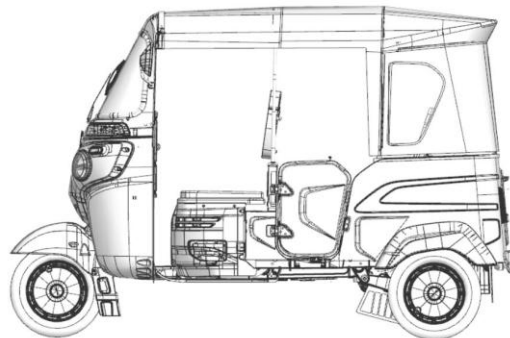

LEFT HAND SIDE VIEW

LEFT

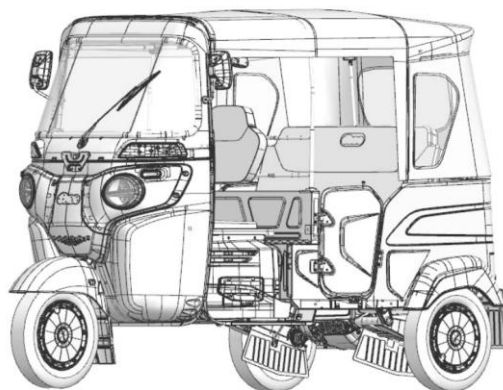

LEFT FRONT PERSPECTIVE VIEW

Government of the People's Republic of Bangladesh
Department of Patents, Industrial Designs & Trademarks
Ministry of Industries
91, Motijheel C/A, Dhaka-1000

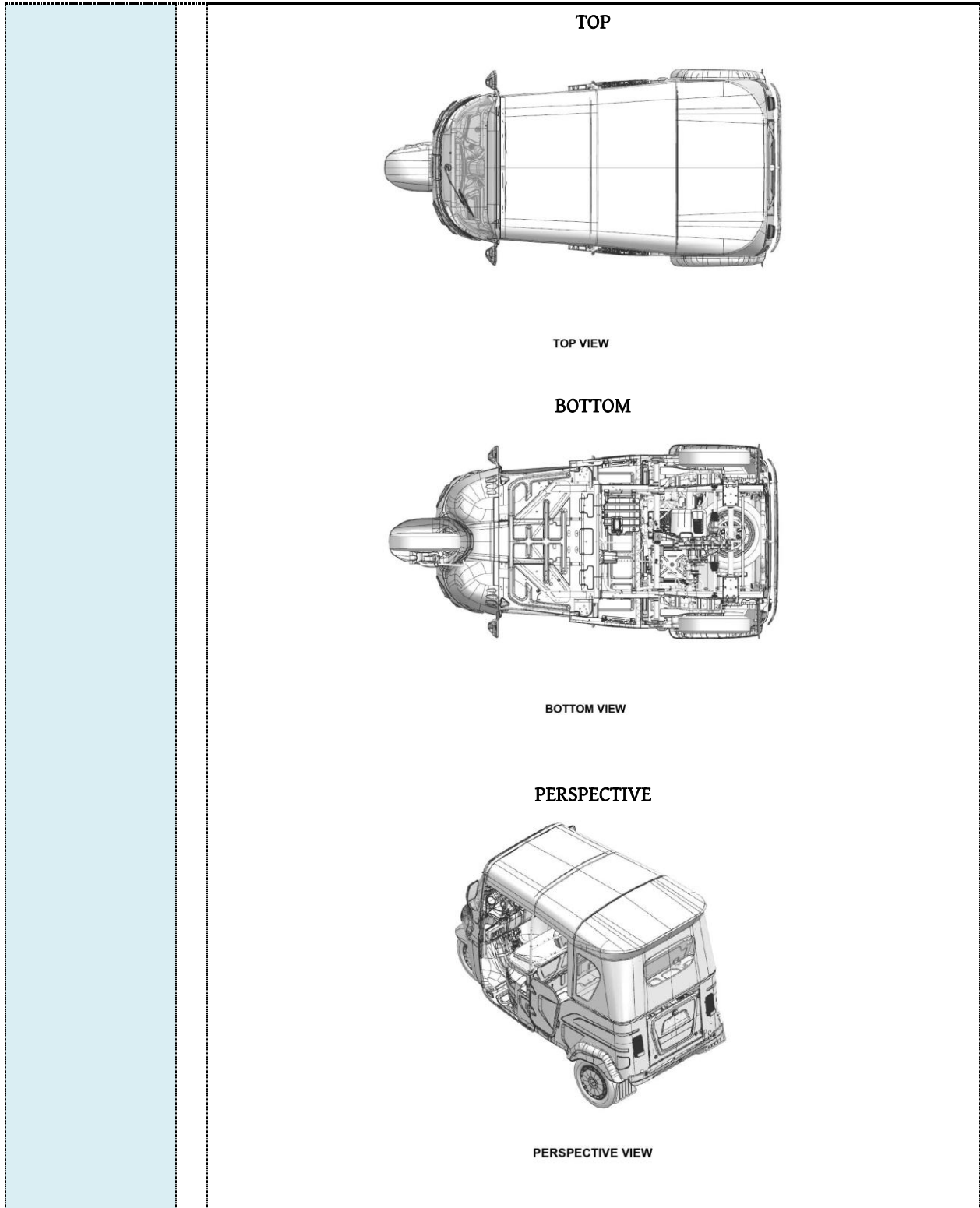



Government of the People's Republic of Bangladesh
 Department of Patents, Industrial Designs & Trademarks
 Ministry of Industries
 91, Motijheel C/A, Dhaka-1000



"Published before acceptance under section 10(1) Proviso"

Application number	: BD-D-2025-290
Title	: THREE WHEELED VEHICLE
Date	: 09/06/2025
Class	: 12-11
Owner & Address	: Bajaj Auto Limited Bajaj Auto Limited, Mumbai-Pune Road, India
Service Address	: Motassir 19/D, East Nayatola, Moghbazar, Dhaka, Bangladesh
Priority	: 440749001
Representation	: <div style="text-align: center;"> <p>FRONT</p>  <p>FRONT VIEW</p> <p>FRONT</p> </div>

Government of the People's Republic of Bangladesh
Department of Patents, Industrial Designs & Trademarks
Ministry of Industries
91, Motijheel C/A, Dhaka-1000



RIGHT FRONT PERSPECTIVE VIEW

RIGHT



RIGHT HAND SIDE VIEW

RIGHT

Government of the People's Republic of Bangladesh
Department of Patents, Industrial Designs & Trademarks
Ministry of Industries
91, Motijheel C/A, Dhaka-1000



RIGHT REAR PERSPECTIVE VIEW

BACK



REAR VIEW

BACK

Government of the People's Republic of Bangladesh
Department of Patents, Industrial Designs & Trademarks
Ministry of Industries
91, Motijheel C/A, Dhaka-1000



LEFT REAR PERSPECTIVE VIEW

LEFT



LEFT HAND SIDE VIEW

LEFT



LEFT FRONT PERSPECTIVE VIEW

Government of the People's Republic of Bangladesh
Department of Patents, Industrial Designs & Trademarks
Ministry of Industries
91, Motijheel C/A, Dhaka-1000

