

BANGLADESH INLAND WATER TRANSPORT AUTHORITY (BIWTA)

141-143 Motijheel C/A, Dhaka-1000, Bangladesh.

T E N D E R D O C U M E N T
FOR THE PROCUREMENT OF GOODS (International)

Tender Document for
Procurement of 2 Nos. 28" Cutter Suction Dredger and Ancillary
Vessel with Other Accessories

Invitation for Tender No: 18.11.0000.311.14.046.2019/2588

Issued on: 26-01-2020

Tender Package No: GD-01

Table of Contents

Section 1. Instructions to Tenderers	5
A. General.....	5
1. Scope of Tender	5
2. Interpretation	5
3. Source of Funds	5
4. Corrupt, Fraudulent, Collusive or Coercive Practices	6
5. Eligible Tenderers	7
6. Eligible Goods and Related Services	8
7. Site Visit	8
B. Tender Document.....	9
8. Tender Document: General	9
9. Clarification of Tender Documents	9
10. Pre-Tender Meeting.....	9
11. Addendum to Tender Documents	10
C. Qualification Criteria	10
12. General Criteria	10
13. Litigation History	11
14. Experience Criteria.....	11
15. Financial Criteria	11
16. Appointment of Subcontractor	11
D. Tender Preparation	12
17. Only One Tender	12
18. Cost of Tendering.....	12
19. Issuance and Sale of Tender Document	12
20. Language of Tender	12
21. Contents of Tender	13
22. Alternatives	14
23. Tender Prices, Discounts.....	14
24. Tender Currency.....	17
25. Documents Establishing the Conformity of the Goods and Related services	17
26. Documents Establishing Qualifications of the Tenderer	17
27. Validity Period of Tender	18
28. Extension of Tender Validity and Tender Security	18
29. Tender Security	18
30. Form of Tender security	19
31. Authenticity of Tender Security	19
32. Return of Tender Security	19
33. Forfeiture of Tender Security.....	20
34. Format and Signing of Tender	20
E. Tender Submission	20
35. Sealing, Marking and Submission of Tender	20
36. Deadline for Submission of tenders.....	21
37. Late tender	21
38. Modification, Substitution or Withdrawal of Tenders.....	21
39. Tender Modification	21
40. Tender Substitution	22
41. Withdrawal of Tender	22
F. Tender Opening and Evaluation.....	22
42. Tender Opening.....	22
43. Evaluation of Tenders.....	24
44. Evaluation process	24
45. Preliminary Examination	24
46. Technical Examinations & Responsiveness.....	25

47. Clarification on Tender	26
48. Restrictions on the Disclosure of Information Relating to the Procurement Process	26
49. Correction of Arithmetical Errors	27
50. Conversion to Single Currency.....	27
51. Domestic Preference.....	27
52. Financial Evaluation.....	28
53. Assessing the Price of Unpriced Items.....	29
54. Evaluation of Domestic Preference	29
55. Price Comparison.....	30
56. Negotiation.....	30
57. Post-qualification	30
58. Rejection of All Tenders	31
59. Informing Reasons for Rejection.....	31
G. Contract Award.....	32
60. Award Criteria.....	32
61. Purchaser's Right to Vary Quantities.....	32
62. Notification of Award	32
63. Performance Security	32
64. Form and Time Limit for furnishing of Performance security	33
65. Validity of Performance Security	33
66. Authenticity of performance Security	33
67. Contract Signing	33
68. Publication of Notification of Award of Contract.....	33
69. Debriefing of Tenderers.....	34
70. Right to Complain	34
Section 2. Tender Data Sheet.....	35
A. General.....	35
B. Tender Document.....	35
C. Qualification Criteria	36
D. Preparation of Tender	37
E. Submission of Tender.....	39
F. Opening and Evaluation of Tenders	39
G. Award of Contract	40
Section 3. General Conditions of Contract	41
1. Definitions	41
2. Contract Documents	42
3. Corrupt, Fraudulent, Collusive or Coercive Practices	42
4. Interpretation	43
5. Documents Forming the Contract in order of precedence	44
6. Eligibility.....	44
7. Governing Language	44
8. Governing Law	44
9. No fees/Gratuities.....	44
10. Use of Contract Documents & Information	45
11. Communications & Notices	45
12. Trademark, Patent and Intellectual Property Rights	45
13. Copyright.....	45
14. Assignment	45
15. Sub contracting	45
16. Supplier's Responsibilities	46
17. Purchaser's Responsibilities	46
18. Scope of Supply	46
19. Amendment to Order	46
20. Instances When Amendment to Order May be Issued	47

21. Adjustments in Contract Price and/or Delivery Schedule in Amendment to Order	47
22. Packing and Documents.....	47
23. Delivery and Documents	48
24. Acceptance	48
25. Contract Price.....	48
26. Transportation.....	49
27. Terms of Payment	49
28. Insurance.....	49
29. Taxes and Duties	49
30. Performance Security	50
31. Specifications and Standards	50
32. Inspections and Tests.....	50
33. Warranty	51
34. Delays in Delivery and Extensions of Time	52
35. Liquidated Damages	52
36. Limitation of Liability	53
37. Change in Laws and Regulations	53
38. Definition of Force Majeure.....	53
39. Notice of Force Majeure.....	54
40. Duty to Minimise Delay	54
41. Consequences of Force Majeure	54
42. Termination for Default.....	54
43. Termination for insolvency	55
44. Termination for Convenience.....	55
45. Procedures for Termination of Contracts.....	56
46. Contract Amendment.....	57
47. Settlement of Disputes	57
Section 4. Particular Conditions of Contract.....	59
Section 5. Tender and Contract Forms	80
Tender Submission Letter (Form PG4 – 1)	81
Tenderer Information Sheet (Form PG4-2)	84
Subcontractor Information (Form PG4-2A)	86
Price Schedule for Goods (Form PG4-3A).....	88
Price Schedule for Goods (Form PG4-3B).....	90
Price Schedule for Goods (Form PG4-3C).....	94
Price and Completion Schedule - Related Services (Form PG4-3D).....	95
Specifications Submission and Compliance Sheet (Form PG4-4).....	97
Manufacturer’s Authorisation Letter (Form PG4 - 5).....	98
Bank Guarantee for Tender Security (Form PG4 – 6)	99
Letter of Commitment for Bank’s Undertaking for Line of Credit (Form PG4-6A) .	100
Notification of Award (Form PG4 - 7)	101
Contract Agreement (Form PG4 - 8).....	102
Bank Guarantee for Performance Security (Form PG4 – 9).....	103
Bank Guarantee for Stage Payment (Form PG4 – 10).....	104
Section 7. Technical Specifications.....	107
Section 8. Drawings	108

Section 1. Instructions to Tenderers

A. General

- 1. Scope of Tender**
 - 1.1 The Purchaser named in the Tender Data Sheet (TDS) (hereinafter referred to as the "Purchaser") wishes to issues these Tender Documents for the supply of Goods, and Related Services incidental thereto, as specified in the TDS and as detailed in Section 6: Schedule of Requirements.
 - 1.2 The name of the Tender and the number and identification of its constituent lot(s) are stated in the TDS.
 - 1.3 The successful Tenderer will be required to complete the delivery of the goods and related services (when applicable) as specified in the GCC Clause **18**.
- 2. Interpretation**
 - 2.1 Throughout this Tender Document
 - (a) the term "in writing" means communication written by hand or machine duly signed and includes properly authenticated messages by facsimile or electronic mail;
 - (b) if the context so requires, singular means plural and vice versa; and
 - (c) "day" means calendar days unless otherwise specified as working days;
 - (d) "Person" means and includes an individual, body of individuals, sole proprietorship, partnership, company, association or cooperative society that wishes to participate in Procurement proceedings;
 - (e) "Tenderer" means a Person who submits a Tender;
 - (f) "Tender Document ", means the Document provided by a Purchaser to a Tenderer as a basis for preparation of its Tender;
 - (g) "Tender ", depending on the context, means a Tender submitted by a Tenderer for delivery of Goods and Related Services to a Purchaser in response to an Invitation for Tender ;
- 3. Source of Funds**
 - 3.1 The Purchaser has been allocated public funds from the source as indicated in the TDS and intends to apply a portion of the funds to eligible payments under the contract for which this Tender Document is issued.
 - 3.2 For the purpose of this provision, "public funds" means any funds allocated to a Purchaser under Government budget, or loan, grants and credits placed at the disposal of a Purchaser through the Government by the development partners or foreign states or organizations.
 - 3.3 Payments by the development partner, if so indicated in the TDS, will be made only at the request of the Government and upon approval by the development partner in accordance with the applicable Loan/Credit/Grant Agreement, and will be subject in all respects to the terms and conditions of that Agreement.

4. Corrupt, Fraudulent, Collusive or Coercive Practices

- 4.1 The Government requires that Procuring Entities, as well as Tenderers shall observe the highest standard of ethics during implementation of procurement proceedings and the execution of Contracts under public funds.
- 4.2 The Government requires that Procuring Entities, as well as Tenderers and Suppliers shall, during the Procurement proceedings and the execution of Contracts under public funds, ensure-
- (a) strict compliance with the provisions of Section 64 of the Public Procurement Act 2006 (Act 24 of 2006);
 - (b) abiding by the code of ethics as mentioned in the Rule 127 of the Public Procurement Rules, 2008;
 - (c) that neither it's any officer nor any staff or any other agents or intermediaries working on its behalf engages in any practice as detailed in ITT Sub Clause 4.3.
- 4.3 For the purposes of ITT Sub-clause 4.2 the terms set forth as bellows:
- (a) **corrupt practice** means offering, giving or promising to give, receiving, or soliciting, either directly or indirectly, to any officer or employee of a Purchaser or other public or private authority or individual, a gratuity in any form; employment or any other thing or service of value as an inducement with respect to an act or decision or method followed by a Purchaser in connection with a Procurement proceeding or contract execution;
 - (b) **fraudulent practice** means the misrepresentation or omission of facts in order to influence a decision to be taken in a Procurement proceeding or Contract execution;
 - (c) **collusive practice** means a scheme or arrangement between two (2) or more Persons, with or without the knowledge of the Purchaser, that is designed to arbitrarily reduce the number of Tenders submitted or fix Tender prices at artificial, non competitive levels, thereby denying a Purchaser the benefits of competitive price arising from genuine and open competition; or
 - (d) **coercive practice** means harming or threatening to harm, directly or indirectly, Persons or their property to influence a decision to be taken in a Procurement proceeding or the execution of a Contract, and this will include creating obstructions in the normal submission process used for Tenders.
 - (e) **“obstructive practice”** (applicable in case of Development Partner) means deliberately destroying, falsifying, altering or concealing of evidence material to the investigation or making false statements to investigators in order to materially impede an investigation into allegations of a corrupt, fraudulent, coercive or collusive practice; and /or threatening, harassing or intimidating any party to prevent it from disclosing its knowledge of matters relevant to the investigation or from pursuing the investigation.
- 4.4 Should any corrupt, fraudulent, collusive or coercive practice of any kind come to the knowledge of the Purchaser, it will, in the first place, allow the Tenderer to provide an explanation and shall, take actions

only when a satisfactory explanation is not received. Such exclusion and the reasons thereof, shall be recorded in the record of the procurement proceedings and promptly communicated to the Tenderer concerned. Any communications between the Tenderer and the Purchaser related to matters of alleged fraud or corruption shall be in writing.

- 4.5 If corrupt, fraudulent, collusive or coercive practices of any kind determined by the Purchaser against any Tenderer alleged to have carried out such practices, the Purchaser shall -
- (a) exclude the concerned Tenderer from further participation in the particular Procurement proceeding; or
 - (b) reject any recommendation for award that had been proposed for that concerned Tenderer or;
 - (c) declare, at its discretion, the concerned Tenderer to be ineligible to participate in further Procurement proceedings, either indefinitely or for a specific period of time.
- 4.6 The Tenderer shall be aware of the provisions on corruption, fraudulence, collusion and coercion in Section 64 of the Public Procurement Act, 2006 and Rule 127 of the Public Procurement Rules, 2008 and others as stated in GCC Clause 3.

5. Eligible Tenderers

- 5.1 This Invitation for Tenders is open to eligible Tenderers from all countries, except for any specified in the TDS. A Tenderer will be eligible if it is a citizen, or is constituted, registered and operates in conformity with the provisions of the laws of that country.
- 5.2 A Tenderer may be a physical or juridical individual or body of individuals, or company, association invited to take part in public procurement or seeking to be so invited or submitting a Tender in response to an Invitation for Tenders.
- 5.3 Government-owned enterprises in Bangladesh shall be eligible only if they can establish that they (i) are legally and financially autonomous, (ii) operate under commercial law, and (iii) are not a dependent agency of the Purchaser.
- 5.4 Tenderers shall have the legal capacity to enter into the Contract. A Tenderer that is under a declaration of ineligibility by the Government of Bangladesh in accordance with applicable laws at the date of the deadline for Tender submission or thereafter shall be disqualified.
- 5.5 Tenderers and all parties constituting the Tenderer shall not have a conflict of interest pursuant to Rule 55 of the Public Procurement Rules, 2008.
- 5.6 Tenderers in its own name or its other names or also in the case of its Persons in different names, shall not be under a declaration of ineligibility for corrupt, fraudulent, collusive, coercive practices as stated under ITT Sub Clause 4.3 (or obstructive practice, in case of Development Partner) in relation to the Development Partner's Regulation/Guidelines in projects financed by Development Partner.

- 5.7 Tenderers are not restrained or barred from participating in public Procurement on grounds of execution of defective supply in the past under any Contract.
- 5.8 Tenderers are not under a declaration of ineligibility by an international financing agency such as World Bank, Asian Development Bank or any other international agency.
- 5.9 Tenderers shall not be insolvent, be in receivership, be bankrupt, be in the process of bankruptcy, be not temporarily barred from undertaking business and it shall not be the subject of legal proceedings for any of the foregoing.
- 5.10 Tenderers shall have fulfilled its obligations to pay taxes and social security contributions under the provisions of laws and regulations of the country of its origin. In the case of foreign Tenderers, a certificate of competent authority in that country of which the Tenderer is citizen shall be provided.
- 5.11 Tenderers shall provide such evidence of their continued eligibility satisfactory to the Purchaser, as the Purchaser will reasonably request.
- 5.12 These requirements for eligibility will extend, as applicable, to Sub-contractor proposed by the Tenderer.

6. Eligible Goods and Related Services

- 6.1 All goods and related services to be supplied under the contract are eligible, unless their origin is from a country specified in the TDS.
- 6.2 For purposes of this Clause, the term “goods” includes commodities, raw material, machinery, equipment, and industrial plants; and “related services” includes services such as insurance, transportation, installation, and commissioning, training, and initial maintenance.
- 6.3 For purposes of this clause, “origin” means the country where the goods have been mined, grown, cultivated, produced, manufactured or processed; or through manufacture, processing, or assembly, another commercially recognized article results that differs substantially in its basic characteristics from its components.
- 6.4 The origin of goods and services is distinct from the nationality of the Tenderer. The nationality of the firm that produces, assembles, distributes, or sells the goods shall not determine their origin.

7. Site Visit

- 7.1 For goods contracts requiring installation/ commissioning/ networking or similar services at site, the Tenderer, at the Tenderer’s own responsibility and risk, is encouraged to visit and examine the Site and obtain all information that may be necessary for preparing the Tender and entering into a contract for the supply of goods and related services.
- 7.2 The Tenderer should ensure that the Purchaser is informed of the visit in adequate time to allow it to make appropriate arrangements.
- 7.3 The costs of visiting the Site shall be at the Tenderer’s own expense.

B. Tender Document

- 8. Tender Document: General**
- 8.1 The Sections comprising the Tender Document are listed below and should be read in conjunction with any addendum issued under ITT Clause 11.
- Section 1 Instructions to Tenderers (ITT)
 - Section 2 Tender Data Sheet (TDS)
 - Section 3 General Conditions of Contract (GCC)
 - Section 4 Particular Conditions of Contract (PCC)
 - Section 5 Tender and Contract Forms
 - Section 6 Schedule of Requirements
 - Section 7 Technical Specifications
 - Section 8 Drawings
- 8.2 The Purchaser shall reject any Tender if the Tender Document was not purchased directly from the Purchaser, or through its agent as stated in the TDS.
- 8.3 The Tenderer is expected to examine all instructions, forms, terms, and specifications in the Tender Document as well as addendum to Tender Documents.
- 9. Clarification of Tender Documents**
- 9.1 A prospective Tenderer requiring any clarification of the Tender Document shall contact the Purchaser in writing at the Purchasers address indicated in the TDS before **two-third** of time allowed for preparation and submission of Tender elapses.
- 9.2 A Purchaser is not obliged to answer any clarification received after that date requested under ITT Sub-Clause 9.1.
- 9.3 The Purchaser shall respond in writing within five (5) working days of receipt of any such request for clarification received under ITT Sub-Clause 9.1
- 9.4 The Purchaser shall forward copies of its response to all those who have purchased the Tender Document, including a description of the enquiry but without identifying its source.
- 9.5 Should the Purchaser deem it necessary to amend the Tender Document as a result of a clarification, it shall do so following the procedure under ITT Clause 11.
- 10. Pre-Tender Meeting**
- 10.1 To clarify issues and to answer questions on any matter arising in the Tender Document, the Purchaser may, if stated in the TDS, hold a Pre-Tender Meeting at the place, date and time as specified in the TDS. All Potential Tenderers are encouraged to attend the meeting, if it is held.
- 10.2 Minutes of the pre-Tender meeting, including the text of the questions raised and the responses given, together with any responses prepared after the meeting, will be transmitted within one week (7 days) after holding the meeting to all those who purchased the Tender Document and even those who did not attend the meeting.

10.3 Any amendment to the Tender Document listed in ITT Sub-Clause 8.1 that may become necessary as a result of the pre-Tender meeting shall be made by the Purchaser exclusively through the issue of an Addendum as stated under ITT Sub-Clause 11 and not through the minutes of the pre-Tender meeting.

10.4 Non-attendance at the pre-Tender meeting will not be a cause for disqualification of a Tenderer.

11. Addendum to Tender Documents

11.1 At any time prior to the deadline for submission of Tenders, the Purchaser on its own initiative or in response to a clarification request in writing from a Tenderer, having purchased the Tender Document or as a result of a Pre-Tender meeting, may revise the Tender Document by issuing an addendum pursuant to Rule 95 of the Public Procurement Rules, 2008.

11.2 The addendum issued under ITT Sub-Clause 11.1 shall become an integral part of the Tender Document and shall have a date and an issue number and shall be circulated by fax, mail or e-mail, to Tenderers who have purchased the Tender Documents within five (5) working days of issuance of such addendum, to enable Tenderers to take appropriate action.

11.3 The Tenderer shall acknowledge receipt of an addendum.

11.4 Tenderers who have purchased the Tender Documents but have not received any addendum issued under ITT Sub-clause 11.1 shall inform the Purchaser of the fact by fax, mail or e-mail before **two-third** of the time allowed for the submission of Tenders has elapsed.

11.5 Procuring Entities shall also ensure posting of relevant addenda with the reference number and date on their website.

11.6 To give a prospective Tenderer reasonable time in which to take an amendment into account in preparing its Tender, the Purchaser may, at its discretion, extend the deadline for the submission of Tenders, pursuant to Rule 95(6) of the Public Procurement Rule, 2008 and under ITT Clause 36.

11.7 If an addendum is issued when time remaining is less than one-third of the time allowed for the preparation of Tenders, a Purchaser shall extend the deadline by an appropriate number of days for the submission of Tenders, depending upon the nature of the Procurement requirement and the addendum. The minimum time for such extension shall not be less than seven (7) days.

C. Qualification Criteria

12. General Criteria

12.1 The Purchaser requires the Tenderer to be qualified by meeting predefined, precise minimum requirements, which entails setting pass/fail criteria, which if not met by the Tenderer, will result in rejection of its Tender.

- 12.2 In addition to meeting the eligibility criteria, as stated in ITT Clause 5, the Tenderer must satisfy the other criteria stated in ITT Clauses 13 to 15 inclusive.
- 12.3 To qualify for a multiple number of lots in a package for which tenders are invited in the Invitation for Tenders, The Tenderer shall demonstrate having resources and experience sufficient to meet the aggregate of the qualifying criteria for the individual lot. The requirement of overall experience and specific experience under ITT Sub-Clause 14.1 (a) and 14.1 (b) shall not be separately applicable for individual lot.
- 13. Litigation History**
- 13.1 The maximum number of arbitration awards against the Tenderer over a period shall be as specified in the TDS.
- 14. Experience Criteria**
- 14.1 Tenderers shall have the following minimum level of supply experience to qualify for supplying the Goods and Related Services under the contract:
- (a) A minimum number of years of overall experience in the supply of goods and related services as specified in the TDS;
 - (b) Specific experience of satisfactory completion of supply of Goods similar to the proposed goods in at least a number of contract(s) and, each with a minimum value, over the period, as specified in TDS; and
 - (c) A minimum supply and/or production capacity of Goods as specified in the TDS.
- 15. Financial Criteria**
- 15.1 Tenderers shall have the following minimum level of financial capacity of qualify for the supply of goods under the contract:
- (a) Availability of minimum liquid assets or working capital or credit facilities from a Bank, as specified in the TDS.
- 16. Appointment of Subcontractor**
- 16.1 Tenderer, pursuant to Rule 53 of the PPR2008, is allowed to subcontract a portion of the Supply.
- 16.2 The Tenderer shall specify in its Tender all portion of the Goods that will be Subcontracted, if any, including the entity(ies) to whom each portion will be subcontracted to, subject to the maximum allowable limit for subcontracting of Goods specified in the TDS.
- 16.3 All subcontracting arrangement must be disclosed at the time of Tendering, and subcontractors must be identified in the Tender submitted by Tenderer.
- 16.4 A Subcontractor may participate in more than one Tender, but only in that capacity.
- 16.5 Subcontractors must comply with the provision of ITT Clause 5. For this purpose contractor shall complete the Subcontractor's information in Form PG4-2A for submission with tender.

- 16.6 If the Purchaser determines that a subcontractor is ineligible, the subcontracting of such portion of the Goods assigned to the ineligible subcontractor shall be disallowed.

D. Tender Preparation

17. Only One Tender

- 17.1 If a Tender for Goods is invited on 'lot-by-lot' basis, each lot shall constitute a Tender. A Tenderer shall submit only one (1) Tender for each lot. A Tenderer who submits or participates in more than one (1) Tender for each lot will cause all the Tenders with that Tenderer's participation to be rejected.

18. Cost of Tendering

- 18.1 Tenderers shall bear all costs associated with the preparation and submission of its Tender, and the Purchaser shall not be responsible or liable for those costs, regardless of the conduct or outcome of the Tendering process.

19. Issuance and Sale of Tender Document

- 19.1 A Purchaser, pursuant to Rule 94 of the Public Procurement Rules, 2008 shall make Tender Documents available immediately to the potential Tenderers, requesting and willing to purchase at the corresponding price if the advertisement has been published in the newspaper pursuant to Rule 90 of the Public Procurement Rules, 2008.
- 19.2 Full contact details with mailing address, telephone and facsimile numbers and electronic mail address, as applicable, of those to whom Tender Documents have been issued shall be recorded with a reference number by the Purchaser or its agent.
- 19.3 There shall not be any pre-conditions whatsoever, for sale of Tender Document and the sale of such Document shall be permitted up to the day prior to the day of deadline for the submission of Tender.

20. Language of Tender

- 20.1 Tenders shall be written in English language. Supporting documents and printed literature furnished by the Tenderer may be in another language provided they are accompanied by an accurate translation of the relevant passages into the English language, in which case, for purposes of interpretation of the Tender, such translation shall govern.
- 20.2 Tenderers shall bear all costs of translation to the governing language and all risks of the accuracy of such translation.

21. Contents of Tender

21.1 The Tender prepared by the Tenderer shall comprise the following:

- (a) Tender Submission Letter (Form PG4-1) as furnished in Section 5: Tender and Contract Forms;
- (b) Tenderer information sheet (Form PG4-2) and Subcontractor Information (Form PG4-2A) as furnished in Section 5: Tender and Contract Forms;
- (c) The completed Price Schedule for Goods and Related Services (Form PG4-3A, 3B, 3C and PG4-3D) as furnished in Section 5: Tender and Contract Forms as stated under ITT Clauses 23 and 24;
- (d) Tender Security as stated under ITT Clause 29,30 and 31;
- (e) The completed Specifications Submission and Compliance Sheet (Form PG4-4) as furnished in Section 5: Tender and Contract Forms as stated under ITT clause 25.2;
- (f) Alternatives, if permitted, as stated under with ITT Clause 22;
- (g) Written confirmation authorising the signatory of the Tender to commit the Tenderer, as stated under ITT Sub-Clause 34.3;
- (h) The completed eligibility declarations, to establish its eligibility as stated under ITT Clause 5, in the Tender Submission Sheet (Form PG4-1), as furnished in section 5: Tender and Contract Forms;
- (i) An affidavit confirming the legal capacity stating that there are no existing orders of any judicial court that prevents either the Tenderer or employees of a Tenderer entering into or signing a Contract with the Purchaser as stated under ITT clause 5;
- (j) An affidavit confirming that the Tenderer is not insolvent, in receivership or not bankrupt or not in the process of bankruptcy, not temporarily barred from undertaking their business for financial reasons and shall not be the subject of legal proceedings for any of the foregoing as stated under ITT Clause 5;
- (k) A certificate issued by the competent authority stating that the Tenderer is a Tax payer having valid Tax identification Number (TIN) and VAT registration number or in lieu any other document acceptable to the Purchaser demonstrating that the Tenderer is a genuine Tax payer and has a VAT registration number as a proof of fulfillment of taxation obligations as stated under ITT Clause 5. In the case of foreign Tenderers, a certificate of competent authority in that country of which the Tenderer is citizen shall be provided ;
- (l) Documentary evidence demonstrating that they are enrolled in the relevant professional or trade organizations registered in Bangladesh or in case of foreign tenderer in their country of origin or a certificate concerning their competency issued by a professional institution in accordance with the law of the country of their origin, as stated under ITT Clause 5;
- (m) The country of origin declarations, to establish the eligibility of the Goods and Related Services as stated under ITT Clause 6, in the Price Schedule for Goods and Related Services (Form PG4-3B,

3C and PG4-3D) as, applicable, furnished in Section 5: Tender and Contract Forms;

- (n) Documentary evidence as stated under ITT Clauses 25, that the Goods and Related Services conform to the Tender Documents;
- (o) Documentary evidence as stated under ITT Clause 26 that the Tenderer's qualifications conform to the Tender Documents;
- (p) Documents establishing legal and financial autonomy and compliance with commercial law, as stated under ITT Sub-clause 5.3 in case of government owned entity; and
- (q) Any other document as specified in the TDS.

21.2 The Tenderer shall submit the Tender Submission Letter (Form PG4-1) as furnished in Section 5: Tender and Contract Forms. This form must be completed without any alterations to its format, and no substitutes shall be accepted. All blank spaces shall be filled in with the information requested.

21.3 The Tenderer shall submit the completed Price Schedule for Goods and Related Services (Form PG4-3A, 3B, 3C and PG4-3D), according to their origin as appropriate as furnished in section 5: Tender and Contract Forms.

22. Alternatives

22.1 Unless otherwise stated in the TDS, alternatives shall not be considered.

23. Tender Prices, Discounts

23.1 The prices and discounts quoted by the Tenderer in the Tender Submission Letter (Form PG4-1) and in the Price Schedule (Form PG4-3A, 3B, 3C and PG4-3D) shall conform to the requirements specified below.

23.2 All lots or items as listed in Section 6: Schedule of Requirements must be listed and priced separately on the Price Schedule following the Form PG4-3A, 3B, 3C and PG4-3D as applicable.

23.3 Tenders are being invited either for a single lot or for a number of lots on 'lot-by-lot' basis, as specified in the TDS.

23.4 Each lot shall constitute a Tender, If Tenders for Goods are invited on 'lot-by-lot' basis.

23.5 Tenders being invited for a single lot or for a number of lots on 'lot-by-lot' basis, price quoted shall correspond to 100% of the items specified for each lot and to 100% of the quantities specified for each item of that particular lot and shall correspond to 100% of the total offered lot value, unless otherwise stated in the TDS

- 23.6 A Lot Tender not offering minimum number of items of those being priced based on percentage of the total number of items, and, the corresponding minimum value based on percentage of the total lot value, as specified in the ITT Sub-Clause 23.5 shall also be considered non-responsive.
- 23.7 Subject to ITT Sub-Clause 23.5, a Lot tender not offering a particular item which represents more than fifty percent (50%) of the estimated lot value identified by the Purchaser and specified in the TDS, even if it complies with the requirement of minimum number of items based on percentage of the total number of items as stated under ITT Sub Clause 23.5, shall be considered non-responsive.
- 23.8 The price to be quoted in Tender Submission Letter (Form PG4-1) shall be the total price of the Tender, excluding any discounts offered, only **in case of being awarded more than one lot**, by the Tenderer
- 23.9 a) Tenderers shall quote any unconditional discount in the Tender Submission Letter as stated under ITT Sub Clause 23.9 (b);
- b) Tenderers wishing to offer any unconditional discount shall be equally applicable on all the items of price schedule after arithmetical correction.
- 23.10 Prices shall be quoted as specified in each Price Schedule (Form PG4-3A, 3B, 3C and PG4-3D) as applicable. The dis-aggregation of price components is required solely for the purpose of facilitating the comparison of tenders by the Purchaser. This shall not in any way limit the Purchaser's right to contract on any of the terms offered. In quoting prices, the Tenderer shall be free to use transportation through carriers registered in any eligible Countries. Similarly, the Tenderer may obtain insurance services from any eligible country. Prices shall be entered in the following manner:
- 23.11 For Goods, manufactured within Bangladesh, the prices in the Price schedule (Form PG4-3A) shall be entered separately in the following manner:
- (a) the price of the Goods quoted EXW (ex works, ex factory, ex warehouse, ex showroom, or off-the-shelf, as applicable), including all customs duties and import vat and other taxes already paid or payable on the components and raw material used in the manufacture or assembly of the Goods;
 - (b) VAT payable on account of supplier, if the contract is awarded ; and
 - (c) the price for inland transportation, insurance, and other local costs for the delivery of the Goods to their final destination (Project Site) specified in the TDS.

23.12 For Goods, manufactured outside Bangladesh, to be imported, the prices in the Price schedule (Form PG4-3B) shall be entered separately in the following manner:

- (a) the price of the Goods, quoted CIP (named place of destination, in the Bangladesh) or CIF (named port of destination, in Bangladesh) as specified in the TDS;
- (b) VAT payable on account of supplier, if the contract is awarded; and
- (c) the price for inland transportation, insurance, and other local costs for the delivery of the Goods to their final destination (Project Site) specified in the TDS;
- (d) in addition to the CIP/CIF prices specified in 23.12(a) above, the price of the Goods to be imported may be quoted in other *INCOTERM* and shall be governed by the rules prescribed in the current edition of *INCOTERM* published by the International Chamber of Commerce, Paris, if so specified in the TDS;

23.13 For Goods, manufactured outside Bangladesh, already imported, the prices in the Price schedule (Form PG4-3C) shall be entered separately in the following manner:

- (a) the price of the Goods, including the original import value of the Goods; plus any mark-up ; plus any other related local cost, and custom duties, import VAT and other import taxes already paid on the Goods already imported.
- (b) the custom duties, import VAT and other import taxes already paid (need to be supported with documentary evidence) on the Goods already imported;
- (c) the price of the Goods, obtained as the difference between (a) and (b) above;
- (d) VAT payable on account of supplier, if the contract is awarded; and
- (e) the price for inland transportation, insurance, and other local costs for the delivery of the Goods to their final destination (Project Site) specified in the TDS.

[For previously imported Goods, the quoted price shall be distinguishable from the original import value of these Goods declared to customs and shall include any rebate or mark-up of the local agent or representative and all local costs except import duties and taxes, which have been paid. For clarity the tenderers are asked to quote the price including import duties, and additionally to provide the import duties and the price net of import duties which is the difference of those values.]

23.14 for Related Services, other than inland transportation and other services required to convey the Goods to their final destination, whenever such Related Services are specified in the Schedule of Requirements, the

prices in the price schedule (Form PG4-3D) shall be entered in the following manner :

- (a) the price of each item comprising the Related Services (inclusive of any applicable taxes).

**24. Tender
Currency**

- 24.1 For expenditures that will be incurred in Bangladesh, the Tenderer shall quote the prices in Bangladeshi Taka (BDT).
- 24.2 Suppliers offering Goods manufactured or assembled in Bangladesh, are permitted to submit their Tender in a combination of local and foreign currencies.
- 24.3 For expenditures that will be incurred outside Bangladesh, the Tenderer may quote the prices in USD or GBP or EUR or JPY as specified in TDS.

**25. Documents
Establishing the
Conformity of
the Goods and
Related
services**

- 25.1 To establish the conformity of the Goods and Related Services to the Tender Documents, the Tenderer shall furnish as part of its Tender the documentary evidence that the Goods and Related services conform to the technical specifications and standards in Section 7, Technical Specifications.
- 25.2 Documentary evidence of conformity of the Goods and services to the Tender Documents may be in the form of literature, drawings, and data, and shall consist of:
 - (a) a detailed description of the essential technical and performance characteristics of the Goods;
 - (b) if so required in TDS, tenderer shall also furnish a list giving full particulars, including available sources and current prices of spare parts, special tools, etc., necessary for the proper and continuing functioning of the Goods during the period specified in the TDS, following commencement of the use of the Goods by the Purchaser ; and
 - (c) an item-by-item commentary on the Purchaser's Technical Specifications demonstrating substantial responsiveness of the Goods and Related services to those specifications, or a statement of deviations and exceptions to the provisions of Section 7. Technical Specifications.

**26. Documents
Establishing
Qualifications
of the Tenderer**

- 26.1 The documentary evidence of the Tenderer's qualifications to perform the contract if its Tender is accepted shall establish to the Purchaser's satisfaction:
 - (a) that the Tenderer meets each of the qualification criterion specified in Sub-Section C, Qualification Criteria of the ITT;
 - (b) that, if required in the TDS, a Tenderer that does not manufacture or produce the Goods it offers to supply shall submit the Manufacturer's Authorization Letter (Form PG4-5) furnished in Section 5: Tender and Contract Forms, to demonstrate that it has been duly authorized by the manufacturer or producer of the Goods to supply the Goods to Bangladesh.; and
 - (c) that, if required in the TDS, in case of a Tenderer not doing business within Bangladesh, the Tenderer is or will be (if awarded the

contract) represented by an Agent in the country equipped and able to carry out the Supplier's maintenance.

- (d) adequacy of minimum liquid assets i.e. working capital substantiated by Audit Reports or Bank Statement or credit line(s) substantiated in the format as specified (**Form PG4-6A**), without alteration as stated under ITT Sub Clause 15.1(a);

27. Validity Period of Tender

27.1 Tender validities shall be determined on the basis of the complexity of the Tender and the time needed for its examination, evaluation, approval of the Tender and issuance of the Notification of Award pursuant to Rule 19 and 20 of the Public Procurement Rules,2008.

27.2 Tenders shall remain valid for the period specified in the TDS after the date of Tender submission deadline prescribed by the Purchaser, as stated under ITT Clause 36. A Tender valid for a period shorter than that specified will be rejected by the Purchaser as non- responsive.

28. Extension of Tender Validity and Tender Security

28.1 In justified exceptional circumstances, prior to the expiration of the Tender validity period, the Purchaser following Rule 21 of the Public Procurement Rules, 2008 may solicit, **not later than ten (10) days** before the expiry date of the Tender validity, compulsorily all the Tenderers' consent to an extension of the period of validity of their Tenders.

28.2 The request for extension of Tender validity period shall state the new date of the validity of the Tender.

28.3 The request from the Purchaser and the responses from the Tenderers will be made in writing.

28.4 Tenderers consenting in writing to the request made by the Purchaser under ITT Sub-Clause 28.1 shall also correspondingly extend the validity of its Tender Security for twenty-eight (28) days beyond the new date for the expiry of Tender validity.

28.5 Tenderers consenting in writing to the request under ITT Sub-Clause 28.1 shall not be required or permitted to modify its Tender in any circumstances.

28.6 If the Tenderers are not consenting in writing to the request made by the Purchaser under ITT Sub-Clause 28.1, its Tender will not be considered for subsequent evaluation.

29. Tender Security

29.1 The Tender Security and its amount shall be determined sufficient to discourage the submission of frivolous and irresponsible tenders pursuant to Rule 22 of the Public Procurement Rule,2008 and shall be expressed as a rounded fixed amount and, shall not be stated as a precise percentage of the estimated total Contract value.

29.2 The Tenderer shall furnish as part of its Tender, in favour of the Purchaser or as otherwise directed on account of the Tenderer as specified in TDS.

- 29.3 Amount of the Tender security may be determined on the basis of different percentages for each lot, but the amount in fixed and currency as specified in TDS, if so indicated that the Tenders are invited on lot-by-lot basis under ITT Sub Clause 23.3
- 30. Form of Tender security**
- 30.1 The Tender Security shall be in the form of an irrevocable bank guarantee issued by an internationally reputable bank and shall require to be endorsed by its any correspondent bank located in Bangladesh, to make it enforceable, in the format (Form PG4-6) furnished in Section 5: Tender and Contract Forms;
- 30.2 be payable promptly upon written demand by the Purchaser in the case of the conditions listed in ITT Clause 33 being invoked; and
- 30.3 remain valid for at least twenty eight (28) days beyond the expiry date of the Tender Validity in order to make a claim in due course against a Tenderer in the circumstances detailed under ITT Clause 33 and pursuant to Rule 25 of the Public Procurement Rules,2008.
- 31. Authenticity of Tender Security**
- 31.1 The authenticity of the Tender security submitted by a Tenderer shall be examined and verified by the Purchaser in writing from the Bank issuing the security, prior to finalization of the Evaluation Report pursuant to Rule 24 of the Public Procurement Rule, 2008.
- 31.2 If a Tender Security is found to be not authentic, the Tender which it covers shall not be considered for subsequent evaluation and in such case the Purchaser shall proceed to take punitive measures against that Tenderer as stated under ITT Sub-Clause 4.6, pursuant to Rule 127 of the Public Procurement Rules, 2008 and in accordance with Section 64(5) of the Public Procurement Act, 2006.
- 31.3 Tender not accompanied by a valid Tender Security as stated under Sub-Clause 29, 30 and 31, shall be considered as non-responsive.
- 32. Return of Tender Security**
- 32.1 No Tender security shall be returned by the Tender Opening Committee (TOC) during and after the opening of the Tenders pursuant to Rule 26 of the Public Procurement Rules 2008.
- 32.2 No Tender security shall be returned to the Tenderers before contract signing, except to those who are found non-responsive.
- 32.3 Tender securities of the non-responsive Tenders shall be returned immediately after the Evaluation Report has been approved by the Purchaser.
- 32.4 Tender securities of the responsive Tenderers shall be returned only after the lowest evaluated responsive Tenderer has submitted the performance security and signed the contract , that being even before the expiration of the validity period specified in Clause 27.
- 32.5 Tender Securities of the Tenderers not consenting within the specified date in writing to the request made by the Purchaser under ITT Sub-Clause 28.1 in regard to extension of its Tender validity shall be discharged or returned forthwith.

33. Forfeiture of Tender Security

- 33.1 The Tender security pursuant to Rule 25 of the Public Procurement Rules, 2008 may be forfeited if a Tenderer:
- (a) withdraws its Tender after opening of Tenders but within the validity of the Tender as stated under ITT Clauses 27, and 28, pursuant to Rule 19 of the Public Procurement Rules 2008; or
 - (b) refuses to accept a Notification of Award as stated under ITT Sub-Clause 62.3, pursuant to Rule 102 of the Public Procurement Rules 2008; or
 - (c) fails to furnish performance security as stated under ITT Sub-Clause 63.2, pursuant to Rule 102 of the Public Procurement Rules 2008; or
 - (d) refuses to sign the Contract as stated under ITT Sub-Clause 67.2 pursuant to Rule 102 of the Public Procurement Rules 2008; or
 - (e) does not accept the correction of the Tender price following the correction of arithmetic errors as stated under ITT Clause 49, pursuant to Rule 98(11) of the Public Procurement Rules 2008

34. Format and Signing of Tender

- 34.1 The Tenderer shall prepare one (1) original of the documents comprising the Tender as described in ITT Clause 21 and clearly mark it "ORIGINAL". In addition, the Tenderer shall prepare the number of copies of the Tender, as specified in the TDS and clearly mark each of them "COPY". In the event of any discrepancy between the original and the copies, the original shall prevail.
- 34.2 Alternatives, if permitted under ITT Clause 22, shall be clearly marked "Alternative".
- 34.3 The original and each copy of the Tender shall be typed or written in indelible ink and shall be signed by a person duly authorised to sign on behalf of the Tenderer. This authorisation shall consist of a written authorisation and shall be attached to the Tender Submission Letter (Form PG4-1).
- 34.4 The name and position held by each person signing the authorisation must be typed or printed below the signature.
- 34.5 All pages of the original and of each copy of the Tender, except for un-amended printed literature, shall be numbered sequentially and signed or initialled by the person signing the Tender.
- 34.6 Any interlineations, erasures, or overwriting shall be valid only if they are signed or initialled by the person(s) signing the Tender.
- 34.7 Person(s) signing the Tender shall describe his or her name, address, position.

E. Tender Submission

35. Sealing, Marking and Submission of Tender

- 35.1 The Tenderer shall enclose the original in one (1) envelope and all the copies of the Tender, including the alternative, if permitted under ITT Clause 22 in another envelope, duly marking the envelopes as "ORIGINAL" "ALTERNATIVE" (if permitted) and "COPY." These sealed envelopes will then be enclosed and sealed in one (1) single outer envelope.

- 35.2 Tenders shall be properly marked by Tenderers in order not be confused with other types of correspondence which may also be hand-delivered or posted by mail or courier service. The inner and outer envelopes shall:
- (a) bear the name and address of the Tenderer ;
 - (b) be addressed to the Purchaser as stated under ITT Sub-Clause 36.1;
 - (c) bear the specific identification of this tendering process indicated in ITT Sub-Clause 1.2 and any additional identification marks as specified in the TDS; and
 - (d) bear a statement “DO NOT OPEN BEFORE...” the time and date for Tender opening, as stated under ITT Sub- Clause 42.2
- 35.3 The Tenderer is solely and entirely responsible for pre-disclosure of Tender information if the envelope(s) are not properly sealed and marked.
- 35.4 Tenders shall be delivered by hand or by mail, including courier services to location as designated in the ITT Sub-Clause 36.1.
- 35.5 Tenders shall be submitted on the basis of this Tender Document issued by the Purchaser.
- 35.6 The Purchaser will, on request, provide the Tenderer with a receipt showing the date and time when it's Tender was received.
- 35.7 When so specified in the TDS, tenderers shall have the option of submitting their tenders electronically.
- 35.8 Tenderers submitting tenders electronically shall follow the electronic tender submission procedures specified in the TDS.
- 36. Deadline for Submission of tenders**
- 36.1 Tenders shall be delivered to the Purchaser at the address specified in the TDS and no later than the date and time specified in the TDS.
- 36.2 The Purchaser may, at its discretion on justifiably acceptable grounds duly recorded, extend the deadline for submission of Tender as stated under ITT Sub Clause 36.1, in which case all rights and obligations of the Purchaser and Tenderers previously subject to the deadline will thereafter be subject to the new deadline as extended.
- 37. Late tender**
- 37.1 Any Tender received by the Purchaser after the deadline for submission of Tenders as stated under ITT Sub-Clause 36.1, shall be declared LATE, rejected, returned unopened to the Tenderer.
- 38. Modification, Substitution or Withdrawal of Tenders**
- 38.1 A Tenderer may modify, substitute or withdraw its Tender after it has been submitted by sending a written notice duly signed by the authorised signatory properly sealed, and shall include a copy of the authorisation (the power of attorney), confirmed by an affidavit duly authenticated as stated under ITT Clause 34.3, provided that such written notice including the affidavit is received by the Purchaser prior to the deadline for submission of Tenders as stated under ITT Sub-Clause 36.1.
- 39. Tender Modification**
- 39.1 The Tenderer shall not be allowed to retrieve its original Tender, but shall be allowed to submit corresponding modification to its original Tender marked as “MODIFICATION”.

- 40. Tender Substitution** 40.1 The Tenderer shall not be allowed to retrieve its original Tender, but shall be allowed to submit another Tender marked as “SUBSTITUTION”.
- 41. Withdrawal of Tender** 41.1 The Tenderer shall be allowed to withdraw its Tender by a Letter of Withdrawal marked as “WITHDRAWAL”.

F. Tender Opening and Evaluation

- 42. Tender Opening** 42.1 Tenders shall be opened pursuant to Rule 97 following steps in Part D of Schedule IV of The Public Procurement Rule, 2008.
- 42.2 Tenders shall be opened in public immediately after the deadline for submission of Tenders at the place, date and time as specified in the TDS but no later than **ONE HOUR** after expiry of the submission deadline. Tender opening shall not be delayed on the plea of absence of Tenderers or his or her representatives.
- 42.3 Any specific electronic Tender opening procedures required if electronic tendering is permitted under ITT Sub-Clause 35.7, shall be as specified in the TDS.
- 42.4 Persons not associated with the Tender may not be allowed to attend the public opening of Tenders.
- 42.5 The Tenderers’ representatives shall be duly authorized by the Tenderer. Tenderers or their authorised representatives will be allowed to attend and witness the opening of Tenders, and will sign a register evidencing their attendance.
- 42.6 The authenticity of withdrawal or substitution of, or modifications to original Tender, if any made by a Tenderer in specified manner, shall be examined and verified by the Tender Opening Committee based on documents submitted under ITT Sub Clause 38.1.
- 42.7 Tenders will be opened in the following manner:
- (a) firstly, envelopes marked “Withdrawal” shall be opened and “Withdrawal” notices read aloud and recorded, and the envelope with the corresponding Tender shall not be opened, but returned unopened to the Tenderer by the Purchaser at a later time immediately after preliminary examination by the Tender Evaluation Committee (TEC) as stated under ITT Sub-Clause 45.1. No Tender withdrawal shall be permitted unless the corresponding withdrawal notice contains a valid authorization to request the withdrawal and in such case the Tender shall be read aloud at the Tender opening ;
 - (b) secondly, the remaining Tenders will be sorted out and those marked “substitutes” or “modified” will be linked with their corresponding “original”(O) Tender;

- (c) Next, envelopes marked “Substitution”(S) shall be opened and read aloud and recorded, and exchanged with the corresponding Tender being substituted, and the substituted Tender shall not be opened, but returned unopened to the Tenderer by the Purchaser at a later time immediately after preliminary examination by the Tender Evaluation Committee (TEC) as stated under ITT Sub-Clause 45.1 . No Tender substitution shall be permitted unless the corresponding substitution notice contains a valid authorization to request the substitution and in such case the Tender shall be read aloud at the Tender opening.
- (d) Next envelopes marked “Modification” (M) shall be opened and read aloud with the corresponding Tender and recorded. No Tender modification shall be permitted unless the corresponding modification notice contains a valid authorization to request the modification and in such case the Tender shall be read aloud at the Tender opening.
- (e) thirdly, if so specified in this Tender Document, the envelopes marked “ Alternative ”(A) shall be opened and read aloud with the corresponding Tender and recorded.

42.8 Ensuring that only the correct (M), (S), (A),(O) envelopes are opened, details of each Tender will be dealt with as follows:

- (a) the Chairperson of the Tender Opening Committee will read aloud each Tender and record in the Tender Opening Sheet (TOS)
 - (i) the name and address of the Tenderer;
 - (ii) state if it is a withdrawn, modified, substituted , or original tender;
 - (iii) the Tender price;
 - (iv) the number of initialled corrections;
 - (v) any discounts;
 - (vi) any alternatives;
 - (vii) the presence or absence of any requisite Tender Security; and
 - (viii) such other details as the Purchaser, at its discretion, may consider appropriate.
- (b) only discounts and alternative read aloud at the Tender opening will be considered in evaluation;
- (c) all pages of the original version of the Tender, except for un-amended printed literature, will be initialled by members of the Tender Opening Committee.

42.9 Upon completion of Tender opening, all members of the Tender Opening Committee and the Tenderers or Tenderer’s duly authorised representatives attending the Tender opening shall sign by name, address, designation and their national Identification Numbers the Tender Opening Sheet, copies of which shall be issued to the Head of the Purchaser or an officer authorised by him or her and also to the members of the Tender Opening Committee and any authorised Consultants and, to the Tenderers immediately.

42.10 The omission of a Tenderer’s signature on the record shall not invalidate the contents and effect of the record under ITT Sub-Clause 42.8.

42.11 No Tender will be rejected at the Tender opening stage except the LATE Tenders. .

42.12 A copy of the record shall be distributed to all Tenderers who submitted tenders in time, and posted online when electronic tendering is permitted.

43. Evaluation of Tenders

43.1 Purchaser's Tender Evaluation Committee (TEC) shall examine, evaluate and compare Tenders that are responsive to the mandatory requirements of Tender Documents in order to identify the successful Tenderer.

43.2 Tenders shall be examined and evaluated only on the basis of the criteria specified in the Tender Document.

44. Evaluation process

44.1 The TEC may consider a Tender as responsive in the Evaluation, only if it is submitted in compliance with the mandatory requirements set out in the Tender Document. The evaluation process should begin immediately after tender opening following four steps:

- (a) Preliminary Examination;
- (b) Technical Examinations and Responsiveness;
- (c) Financial evaluation and price comparison;
- (d) Post-qualification of the lowest evaluated responsive Tenders.

45. Preliminary Examination

45.1 Compliance, adequacy and authenticity of the documentary evidences for meeting the qualification criterion specified in the corresponding section of the Tender document shall have to be preliminarily examined and verified.

45.2 The TEC shall firstly examine the Tenders to confirm that all documentation requested in ITT Clause 21 has been provided. Examination of the compliance, adequacy and authenticity of the documentary evidence may follow the order below:

- (a) verification of the completeness of the eligibility declaration in the Tender Submission Letter (Form PG4-1), to determine the eligibility of the tenderer as stated under ITT Sub-Clause 21(h). Any alterations to its format, filling in all blank spaces with the information requested, failing which the tender may lead to rejection of the Tender;
- (b) verification of that the Tenderer is enrolled in the relevant professional or trade organisations as stated under ITT Clause 21(l);
- (c) verification of the eligibility in terms of legal capacity and fulfilment of taxation obligation by the tenderer in accordance as stated under ITT Sub-Clause 21(i) and 21(k);
- (d) verification of eligibility that the tenderer is not insolvent, in receivership, bankrupt, not in the process of bankruptcy, not temporarily barred as stated under ITT Sub-Clause 21(j);
- (e) verification of eligibility of Tenderer's country of origin as stated under ITT Sub-Clause 21(b);
- (f) verification of the written authorization confirming the signatory of the Tenderer to commit the Tender has been attached with Tender Submission Letter (Form PG4-1) as stated under ITT Sub-Clause 21(g); in order to check the authenticity of Tender and Tenderer itself ;

- (g) verification of the Tender Security as stated under ITT Sub-Clause 21(d); and
- (h) Verification of that the written notice for 'WITHDRAWAL' and 'SUBSTITUTION of' or MODIFICATION to, the corresponding Tender is proper and authentic, if the tender is "WITHDRAWN", "SUBSTITUTION" or "MODIFICATION", as stated under ITT Sub-Clause 38.1

45.3 The TEC shall confirm that the above documents and information have been provided in the Tender and the completeness of the documents and compliance of instructions given in corresponding ITT Clauses shall be verified, failing which the tender shall be considered as non-responsive.

46. Technical Examinations & Responsiveness

46.1 Only those Tenders surviving preliminary examination need to be examined in this phase.

46.2 Secondly, the TEC will examine the adequacy and authenticity of the documentary evidence which may follow the order below:

- (a) verification of the completeness of the country of origin declaration in the Price Schedule for Goods and Related Services (Form PG4-3B, 3C and PG4-3D) as furnished in Section 5: Tender and Contract Forms to determine the eligibility of the Goods and Related Services as stated under ITT Sub Clause 21(m).
- (b) verification and examination of the documentary evidence and completed Specification Submission Sheet (Form PG4-4) as furnished in Section 5: Tender and Contract Forms to establish the conformity of the Goods and Related Services to the Tender Documents as stated under ITT Sub Clause 21(e) and 21(n).
- (c) verification and examination of the documentary evidence that the Tenderer's qualifications conform to the Tender Documents and the Tenderer meets each of the qualification criterion specified in Sub-Section C, Qualification Criteria as stated under ITT Sub Clause 21(o).
- (d) verification and examination of the documentary evidence that Tenderer has met all the requirements in regards to scope of Supply as stated under Section 6, Schedule of Requirements, without any material deviation or reservation.

46.3 TEC may consider a Tender as responsive in the evaluation, only if comply with the mandatory requirements as stated under Clause 46.2.

46.4 The TEC's determination of a Tender's responsiveness is to be based on the documentary evidence as requested in Clause 46.2 without recourse to extrinsic evidence.

46.5 Information contained in a Tender, that was not requested in the Tender Document shall not be considered in evaluation of the Tender.

46.6 If a Tender is not responsive to the mandatory requirements set out in the Tender Document it shall be rejected by the TEC and shall not subsequently be made responsive by the Tenderer by correction of the material deviation, reservation.

46.7 A material deviation or reservation is one-

- (a) which affects in any substantial way the scope, quality, or performance of the Goods and Related Services and Tenderer's qualifications mentioned in the Tender Document.
- (b) which limits in any substantial way, inconsistent with the Tender Documents, the Purchaser's rights or the Tenderer's obligations under the Contract; or
- (c) whose rectification would anyway affect unfairly the competitive position of other Tenderers presenting responsive Tenders.

46.8 During the evaluation of Tender, the following definitions apply:

- (a) "Deviation" is a departure from the requirements specified in the Tender Document;
- (b) "Reservation" is the setting of limiting conditions or withholding from complete acceptance of the requirements specified in the Tender Document;

46.9 A TEC may regard a Tender as responsive, even if it contains-

- (a) minor or insignificant deviations, which do not meaningfully alter or depart from the technical specifications, characteristics and commercial terms and conditions or other requirements set out in the Tender Document;
- (b) errors or oversights, which if corrected, would not alter the key aspects of the Tender.

47. Clarification on Tender

47.1 The TEC may ask Tenderers for clarifications of their Tenders, including breakdowns of unit rates, in order to assist the examination and evaluation of the Tenders, provided that, Tender clarifications which may lead to a change in the substance of the Tender or in any of the key elements of the Tender as stated under ITT Sub-Clause 46.7, shall neither be sought nor permitted by the TEC.

47.2 Change in the tender price shall not be sought or permitted, except to confirm correction of arithmetical errors discovered by the Purchaser in the evaluation of the Tender, as sated under ITT Clause 49.

47.3 Any request for clarifications by the TEC shall not be directed towards making an apparently non-responsive Tender responsive and reciprocally the response from the concerned Tenderer shall not be articulated towards any addition, alteration or modification to its Tender.

47.4 If a Tenderer does not provide clarifications of its Tender by the date and time set in the TEC's written request for clarification, its Tender shall not be considered in the evaluation.

47.5 Requests for clarification shall be in writing and shall be signed only by the Chairperson of the TEC.

48. Restrictions on the Disclosure of Information Relating to the Procurement Process

48.1 Following the opening of Tenders until issuance of Notification of Award no Tenderer shall, unless requested to provide clarification to its Tender or unless necessary for submission of a complaint, communicate with the concerned Purchaser pursuant to Rule 31 of the Public Procurement Rule,2008.

48.2 Tenderers shall not seek to influence in anyway, the examination and evaluation of the Tenders.

48.3 Any effort by a Tenderer to influence a Purchaser in its decision concerning the evaluation of Tenders, Contract awards may result in the rejection of its Tender as well as further action in accordance with Section 64 (5) of the Public Procurement Act 2006.

48.4 All clarification requests shall remind Tenderers of the need for confidentiality and that any breach of confidentiality on the part of the Tenderer may result in their Tender being disqualified.

48.5 Information relating to the examination, evaluation, comparison, and post qualification of the tender or contract award, shall not be disclosed to tenderers or any other persons not officially concerned with such process.

49. Correction of Arithmetical Errors

49.1 The TEC shall correct any arithmetic errors that are discovered during the examination of Tenders, and shall promptly notify the concerned Tenderer(s) of any such correction(s) pursuant to Rule 98(11) of the Public Procurement Rule, 2008.

49.2 Provided that the Tender is responsive, TEC shall correct arithmetical errors on the following basis:

(a) If there is a discrepancy between the unit price and the line item total that is obtained by multiplying the unit price by the quantity, the unit price shall prevail and the line item total shall be corrected, unless in the opinion of the TEC there is an obvious misplacement of the decimal point in the unit price, in which case the total price as quoted will govern and the unit price will be corrected;

(b) If there is an error in a total corresponding to the addition or subtraction of subtotals, the subtotals shall prevail and the total shall be corrected.

49.3 Any Tenderer that does not accept the correction of the Tender amount following correction of arithmetic errors as determined by the application of ITT Sub-Clause 49.2 shall be considered as non-responsive.

50. Conversion to Single Currency

50.1 For evaluation and comparison purpose, TEC shall convert all Tender prices expressed in the amounts in various currencies into an amount in Bangladeshi BDT currency, using the **selling exchange rates** established by the Bangladesh Bank, on the date of **Tender opening**.

51. Domestic Preference

51.1 **Domestic preference** shall be a factor in tender evaluation, unless otherwise specified in the **TDS**

51.2 If **domestic preference shall be a tender-evaluation factor**, the Purchaser will grant a margin of fifteen percent (15%) domestic preference to Goods manufactured in Bangladesh during the evaluation of its Tender while comparing the same with those of other Tenderers under the classification set out in ITT Sub-Clause 51.3. The evaluation will be carried out in accordance with the provisions set out in ITT Clause 54.

51.3 Tenders will be classified in one of two groups, as follows:

(a) **Group A:** Tender offering goods manufactured in Bangladesh, for which:

(i) labour, raw materials, and components from within the Bangladesh account for more than thirty (30) percent of the EXW price; and

- (ii) the production facility in which they will be manufactured or assembled has been engaged in manufacturing or assembling such goods at least since the date of tender submission.
- (b) **Group B:** Tenders offering Goods manufactured outside Bangladesh that have been already imported or that will be imported.

51.4 To facilitate this classification by the Tenderer, the Tenderer shall complete whichever Form of the Price Schedule furnished in the Tender Document is appropriate.

51.5 Completion of an inappropriate Form of the Price Schedule by the Tenderer shall not result in rejection of its tender, but merely in the Purchaser's reclassification of the tenderer into its appropriate tender group.

52. Financial Evaluation

52.1 Thirdly the TEC, pursuant to Rule 98 of the Public Procurement Rules, 2008 shall evaluate each Tender that has been determined, up to this stage of the evaluation, to be responsive to the mandatory requirements in the Tender Document.

52.2 To evaluate a Tender in this stage, the Purchaser shall consider the following:

- (a) Verification and examination of the Price Schedule for Goods and Related Services (Form PG4-3A, 3B, 3C and PG4-3D) as furnished by the Tenderer and checking the compliance with the instructions provided under ITT Clause 23;
- (b) Evaluation will be done for Items or lot by lot as stated under ITT Clause 23 and the Total Tender Price as quoted in accordance with Clause 23 ;
- (c) Adjustment for correction of arithmetical errors as stated under ITT Sub-Clause 49.2;
- (d) Adjustment for price modification offered as stated under ITT Clause 38;
- (e) Adjustment due to discount as stated under ITT Sub-Clauses 23.8 , 23.9 and 52.3;
- (f) Adjustment due to the application of economic factors of evaluation as stated under ITT Sub-Clause 52.5 if any;
- (g) Adjustment due to the assessment of the price of unpriced items as stated under ITT Clause 53 if any;
- (h) Adjustment due to the application of a margin of preference (domestic preference), in accordance with ITT Clause 54 if applicable

52.3 If Tenders are invited for a single lot or for a number of lots as stated under ITT Sub-clauses 23.3, TEC shall evaluate only lots that have included at least the percentage of items per lot as stated under ITT Sub-Clause 23.5 and 23.6. The TEC shall evaluate and compare the Tenders taking into account:

- (a) Lowest evaluated tender for each lot ;
- (b) The price discount/reduction per lot;

- (c) Least cost combination for the Purchaser, considering discounts and the methodology for its application as stated under ITT Sub-clauses 23.8 and 23.9 offered by the Tenderer in its Tender.

52.4 Only those spare parts and tools which are specified as a item in the List of Goods and Related Services in Section 6, Schedule of Requirement or adjustment as stated under ITT Sub-clause 52.5, shall be taken into account in the Tender evaluation. Supplier-recommended spare parts for a specified operating requirement as stated under ITT Sub-clause 25.2(b) shall not be considered in Tender evaluation.

52.5 The Purchaser's evaluation of a tender may require the consideration of other factors, in addition to the Tender Price quoted as stated under ITT Clause 23. The effect of the factors selected, if any, shall be expressed in monetary terms to facilitate comparison of tenders. The factors, methodologies and criteria to be used shall be as specified in TDS. The applicable economic factors, for the purposes of evaluation of Tenders shall be:

- (a) Adjustment for Deviations in the Delivery and Completion Schedule
- (b) Cost of major replacement components, mandatory spare parts, and service

52.6 Variations, deviations, and alternatives and other factors which are in excess of the requirements of the Tender Document or otherwise result in unsolicited benefits for the Purchaser will not be taken into account in Tender evaluation.

53. Assessing the Price of Unpriced Items

53.1 If it is so permitted under ITT Clause 23 , any Tenderer offered only eighty percent (80%) or minimum percent of the items of a lot as stated under ITT Sub-Clause 23.5, the TEC shall calculate the total lot value by adding up the average prices offered by other responsive Tenderers for the missing items to the lot value to establish the winning lot Tender. If the Tenderer offered less than the specified, the Tender shall be evaluated as sated under ITT Clause 23.

53.2 If the winning lot is missing some items as stated under ITT Sub Clause 53.1, comprising less than twenty percent (20%), the Purchaser may procure the missing items from the Tenderer offering the least cost for those remaining items.

54. Evaluation of Domestic Preference

54.1 If the Tender document so specifies, the Tenderer will grant a margin preference to goods manufactured in Bangladesh as stated in ITT Caluse 51 for the purpose of Tender comparison, in accordance with the procedure outlined below:

54.2 The Purchaser will first review the tenders to confirm the appropriateness of, and to modify as necessary, the tenderer group classification to which Tenderers assigned their tenders in preparing their Tender Forms and Price Schedules.

54.3 All evaluated tenders in each group will then be compared to determine the lowest evaluated tender of each group. Such lowest evaluated tenders shall be compared with each other and if as a result of this comparison a tenderer from Group A and the Tenders offering Goods manufactured in Bangladesh is the lowest, it shall be selected for the award.

- 54.4 If, as a result of the preceding comparison, the lowest evaluated tender is from Group B,
- (a) all Group B tenders will then be further compared with the lowest evaluated tender from Group A, after adding to the evaluated tender price of goods offered in the tender for Group B, for the purpose of further comparison only an amount equal to fifteen (15) percent of the CIF/CIP (named place of destination or named port of destination) tender price.
 - (b) The lowest-evaluated tender determined from this last comparison shall be selected for the award.

55. Price Comparison

- 55.1 The TEC shall compare all responsive Tenders to determine the lowest-evaluated Tender, as stated under ITT Clause 54.
- 55.2 In the extremely unlikely event that there is a tie for the lowest evaluated price, the Tenderer with the superior past performance with the Purchaser shall be selected, whereby factors such as delivery period, quality of Goods delivered, complaints history and performance indicators could be taken into consideration.
- 55.3 In the event that there is a tie for the lowest price and none of the Tenderers has the record of past performance with the Purchaser, then the Tenderer shall be selected, subject to firm confirmation through the Post-qualification process described in ITT Clause 57, after consideration as to whether the quality of Goods that is considered more advantageous by the end-users.
- 55.4 The successful Tenderer as stated under ITT Sub Clauses 55.1, 55.2 and 55.3 shall not be selected through lottery under any circumstances.

56. Negotiation

- 56.1 No negotiations shall be held during the Tender evaluation or award with the lowest or any other Tenderer pursuant to Rule 99 of the Public Procurement Rules, 2008.

57. Post-qualification

- 57.1 After determining the lowest-evaluated responsive tender as stated under ITT Sub-Clause 55.1, the Purchaser's TEC pursuant to Rule 100 of the Public Procurement Rules, 2008, shall carry out the Post-Qualification of the Tenderer, using only the requirements specified in Sub-Section C, Qualification Criteria.
- 57.2 The TEC shall contact the references given by Tenderers about their previous Supply experiences to verify, if necessary, statements made by them in their Tender and to obtain the most up-to-date information concerning the Tenderers.
- 57.3 The TEC may visit the premises of the Tenderer as a part of the post-qualification process, if practical and appropriate, to verify information contained in its Tender.
- 57.4 The TEC shall determine to its satisfaction whether the Tenderer that is selected as having submitted the lowest evaluated responsive Tender is qualified to perform the Contract satisfactorily.

57.5 The objective of any visit under ITT Sub-Clause 57.3 shall be limited to a general and visual inspection of the Tenderer's facilities and its plant and equipment, and there shall be no discussion concerning the Tender or its evaluation with the Tenderer during such visit(s).

57.6 In the event that the Tenderer with lowest evaluated cost fails the post-qualification, the TEC shall make a similar determination for the Tenderer offering the next lowest evaluated cost and so on from the remaining responsive Tenders, provided that,

(a) such action shall only be taken if the evaluated costs of the Tenders under consideration are acceptable to the Purchaser;

(b) when the point is reached whereby the evaluated costs of the remaining responsive Tenders are significantly higher than that of the official estimate, or the market price, the Purchaser may take action pursuant to Rule 33 and may proceed for re-Tendering, using a revised Tender Document designed to achieve a more successful result.

58. Rejection of All Tenders

58.1 The Purchaser may, in the circumstances as stated under ITT Sub-Clause 58.2 and pursuant to Rule 33 of the Public Procurement Rules 2008, reject all Tenders following recommendations from the Evaluation Committee only after the approval of such recommendations by the Head of the Purchaser.

58.2 All Tenders can be rejected, if -

(a) the price of the lowest evaluated Tender exceeds the official estimate, provided the estimate is realistic; or

(b) there is evidence of lack of effective competition; such as non-participation by a number of potential Tenderers; or

(c) the Tenderers are unable to propose completion of the delivery within the stipulated time in its offer, though the stipulated time is reasonable and realistic; or

(d) all Tenders are non-responsive; or

(e) evidence of professional misconduct, affecting seriously the Procurement process, is established pursuant to Rule 127 of the Public Procurement Rules, 2008.

58.3 Notwithstanding anything contained in ITT Sub-Clause 58.2 Tenders may not be rejected if the lowest evaluated price is in conformity with the market price.

58.4 A Purchaser may pursuant to Rule 35 of the Public Procurement Rules, 2008, on justifiable grounds, annul the Procurement proceedings prior to the deadline for the submission of Tenders.

58.5 All Tenders received by the Purchaser shall be returned unopened to the Tenderers in the event Procurement proceedings are annulled under ITT Sub-Clause 58.4.

59. Informing Reasons for Rejection

59.1 Notice of the rejection, pursuant to Rule 35 of the Public Procurement Rules, 2008, will be given promptly within seven (7) days of decision taken by the Purchaser to all Tenderers and, the Purchaser will, upon receipt of a written request, communicate to any Tenderer the reason(s) for its rejection but is not required to justify those reason(s).

G. Contract Award

- 60. Award Criteria**
- 60.1 The Purchaser shall award the Contract to the Tenderer whose offer is responsive to the Tender Document and that has been determined to be the lowest evaluated Tender, provided further that the Tenderer is determined to be Post-Qualified as stated under ITT Clause 57.
- 60.2 A Tenderer shall not be required, as a condition for award of contract, to undertake obligations not stipulated in the Tender Document, to change its price, or otherwise to modify its Tender.
- 61. Purchaser's Right to Vary Quantities**
- 61.1 The Purchaser reserves the right at the time of Contract Award to increase or decrease the quantity, per item, of Goods and Related Services originally specified in Section 6: Schedule of Requirements, provided this does not exceed the percentages indicated in the TDS, and without any change in the unit prices or other terms and conditions of the Tender and the Tender Document.
- 62. Notification of Award**
- 62.1 Prior to the expiry of the Tender validity period and within seven (7) working days of receipt of the approval of the award by the Approving Authority, the Purchaser pursuant to Rule 102 of the Public procurement Rules, 2008, shall issue the Notification of Award (NOA) to the successful Tenderer
- 62.2 The Notification of Award, attaching the contract as per the sample (Form PG4-7) to be signed, shall state:
- (a) the acceptance of the Tender by the Purchaser;
 - (b) the price at which the contract is awarded;
 - (c) the amount of the Performance Security and its format;
 - (d) the date and time within which the Performance Security shall be submitted; and
 - (e) the date and time within which the contract shall be signed.
- 62.3 The Notification of Award shall be accepted in writing by the successful Tenderer within seven (7) working days from the date of issuance of NOA.
- 62.4 Until a formal contract is signed, the Notification of Award shall constitute a Contract, which shall become binding upon the furnishing of a Performance Security and the signing of the Contract by both parties.
- 62.5 The Notification of Award establishes a Contract between the Purchaser and the successful Tenderer and the existence of a Contract is confirmed through the signature of the Contract Document that includes all agreements between the Purchaser and the successful Tenderer.
- 63. Performance Security**
- 63.1 The Performance Security shall be determined sufficient to protect the performance of the Contract pursuant to Rule 27 of the Public Procurement Rules, 2008.
- 63.2 Performance Security shall be furnished by the successful Tenderer in the amount specified in the TDS and **denominated in the currencies** in which the Contract Price is payable pursuant to Rule 102 (8) of the Public Procurement Rules, 2008.

- 63.3 The proceeds of the Performance Security shall be payable to the Purchaser unconditionally upon first written demand as compensation for any loss resulting from the Supplier's failure to complete its obligations under the Contract.
- 64. Form and Time Limit for furnishing of Performance security**
- 64.1 The Performance Security shall be in the form of irrevocable Bank Guarantee in the format (Form PG4-9) as stated under ITT Clause 63, **shall be issued by an internationally reputable bank and it shall have correspondent bank located in Bangladesh, to make it enforceable** pursuant to Rule 27(4) of the Public Procurement Rules, 2008..
- 64.2 Within twenty-eight (28) days from issue of the Notification of Award, the successful Tenderer shall furnish the Performance Security for the due performance of the Contract in the amount specified under ITT Sub Clause 63.2.
- 65. Validity of Performance Security**
- 65.1 The Performance Security shall be required to be valid until a date twenty-eight (28) days beyond the date of completion of the Supplier's performance obligations under the Contract, including any warranty obligations.
- 65.2 If under any circumstances date of completion of the Supplier's performance obligations under the Contract, including any warranty obligations is to be extended, the Performance Security shall correspondingly be extended for the extended period.
- 66. Authenticity of performance Security**
- 66.1 The Purchaser shall verify the authenticity of the Performance Security submitted by the successful Tenderer by sending a written request to the branch of the bank issuing irrevocable Bank Guarantee in specified format.
- 66.2 If the Performance Security submitted under ITT Sub Clause 63.2 is not found to be authentic, the Purchaser shall proceed to take measures against the Tenderer in accordance with Section 64 of the Act and pursuant to Rule 127 of the Public Procurement Rules, 2008.
- 67. Contract Signing**
- 67.1 At the same time as the Purchaser issues the Notification of Award, the Purchaser shall send the draft Contract Agreement and all documents forming the Contract pursuant to Rule 102 of the Public Procurement Rule, 2008, to the successful Tenderer.
- 67.2 Within twenty-eight (28) days of the issuance of Notification of Award, the successful Tenderer and the Purchaser shall sign the contract provided that the Performance Security submitted by the Tenderer is found to be genuine.
- 67.3 If the successful Tenderer fails to provide the required Performance Security, as stated under ITT Clause 63 or to sign the Contract, as stated under ITT Sub-Clause 67.2, Purchaser shall proceed to award the Contract to the next lowest evaluated Tenderer, and so on, by order of ranking pursuant to Rule 102 of the Public Procurement Rules,2008.
- 68. Publication of Notification of Award of Contract**
- 68.1 Notification of Awards for Contracts of BDT 10(ten) million and above shall be notified by the Purchaser to the Central Procurement Technical Unit within 7(seven) days of issuance of the NOA for publication in their

website, and that notice shall be kept posted for not less than a month pursuant to Rule 37 of the Public Procurement Rules, 2008.

68.2 Notification of Award for Contracts below BDT 10(ten) million, shall be published by the Purchaser on its Notice Board and where applicable on the website of the Purchaser and that notice shall be kept posted for not less than a month pursuant to Rule 37 of the Public Procurement Rules, 2008..

69. Debriefing of Tenderers

69.1 Debriefing of Tenderers by Purchaser shall outline the relative status and weakness only of his or her Tender requesting to be informed of the grounds for not accepting the Tender submitted by him or her pursuant to Rule 37 of the Public Procurement Rule, 2008, without disclosing information about any other Tenderer.

69.2 In the case of debriefing confidentiality of the evaluation process shall be maintained.

70. Right to Complain

70.1 Any Tenderer has the right to complain if it has suffered or likely to suffer loss or damage due to a failure of a duty imposed on the Purchaser to fulfil its obligations in accordance with Section 29 of the Public Procurement Act 2006 and pursuant to Part 12 of Chapter Three of the Public Procurement Rules, 2008.

70.2 Circumstances in which a formal complaint may be lodged in sequence by a potential Tenderer against a Purchaser pursuant to Rule 56 of the Public Procurement Rules, 2008, and the complaints, if any, be also processed pursuant to Rule 57 of the Public Procurement Rules 2008 .

70.3 The potential Tenderer shall submit his or her complaint in writing within seven (7) calendar days of becoming aware of the circumstances giving rise to the complaint.

70.4 In the first instance, the potential Tenderer shall submit his or her complaint to the Purchaser who issued the Tender Document.

70.5 The place and address for the first stage in the submission of complaints to the Administrative Authority is provided in the TDS.

70.6 The Tenderer may appeal to a Review Panel only if the Tenderer has exhausted all his or her options of complaints to the administrative authority as stated under ITT Sub-Clause 70.2.

Section 2. Tender Data Sheet

<i>Instructions for completing the Tender Data Sheet are provided, as needed, in the notes in italics and under lined mentioned for the relevant ITT clauses.</i>	
ITT Clause	Amendments of, and Supplements to, Clauses in the Instruction to Tenderers
A. General	
ITT 1.1	The Purchaser is: Chairman, BIWTA The Name and identification number of Tender are: Name of the Tender: Procurement of 2 Nos. 28" Cutter Suction Dredger and Ancillary Vessel with Other Accessories Identification number of Tender is: 18.11.0000.311.14.046.2019/2588
ITT 1.2	The number, identification and name of lots comprising the Tender are: Not Applicable
ITT 3.1	The source of public fund is: <i>Government of Bangladesh (GoB).</i>
ITT 3.3	The name of the Development Partner is: None
ITT 5.1	Tenderers from the following countries are not eligible: ISRAEL.
ITT 6.1	Goods and Related Services from the following counties are not eligible: ISRAEL
B. Tender Document	
ITT 8.2	The following are the offices of the Purchaser or authorised agents for the purpose of providing the Tender Document: (a) Accounts Department, BIWTA Bhaban (level-9), 141-143 Motijheel C/A, Dhaka-1000, Bangladesh (b) Social Islami Bank Ltd. (SIBL), Foreign Exchange Branch (Ground Floor), 141-143 Motijheel C/A, Dhaka-1000, Bangladesh
IT3T 9.1	For <u>clarification of Tender purposes</u> only, the Purchaser's address is: Attention: Chief Engineer (Dredging) Address: Dredging Dept. BIWTA Bhaban (level-7), 141-143 Motijheel C/A, Dhaka-1000, Bangladesh. Telephone: +88-02-9552127 Fax number: +88-02-9551072, +88-02-9571453 and +88-02-9552127 Electronic mail address: mamatin77@gmail.com
ITT 10.1	A Pre- Tender meeting shall be held at Office Chief Engineer (Dredging)

	<p>Address: Dredging Dept. BIWTA Bhaban (level-7), 141-143 Motijheel C/A, Dhaka-1000, Bangladesh.</p> <p>Telephone: +88-02-9552127</p> <p>Fax number: +88-02-9551072, +88-02-9571453 and +88-02-9552127</p> <p>Electronic mail address: mamatin77@gmail.com</p> <p>Time and Date: 17-02-2020 on 14:30 Hours</p>
C. Qualification Criteria	
ITT 13.1	The maximum 3 (three) number of arbitrations against the Tenderer over a period of 5 (five) years i.e. years counting backward from the date of publication of IFT in the newspaper.
ITT 14.1(a)	The Tenderer shall have a minimum of 5 (five) years of overall experience in the supply of goods and related services.
ITT 14.1(b)	<p>(i) The minimum specific experience as Supplier in supply of similar Goods (Class dredgers or class vessel) of at least 01(One) contract successfully completed within the last 05 (five) years, each with a value of at least BDT 3150.00 (Three thousand one hundred and fifty) million or US\$ 37.00 (Thirty-seven) million.</p> <p style="text-align: center;">Or</p> <p>The minimum specific experience as Supplier in supply of similar Goods (Class dredgers or class vessel) of at least 02 (Two) contract(s) successfully completed within the last 05 (five) years, each with a value of at least BDT 1575.00 (One thousand five hundred & seventy-five) million or US\$ 19.00(Nineteen) million.</p> <p>(ii) The foreign reputed dredger manufacturer must submit of its at least 20 (twenty) years' experience in manufacturing & overseas supply of class dredgers (with proven documentary evidences). The foreign reputed dredger manufacturer must submit proven satisfactory performance certificate of its class dredgers which is issued by its client (s) supplied.</p> <p style="text-align: center;">Or,</p> <p>The local tenderer who has experience of manufacturing of class dredgers/class vessel, it must have to have at least 5 (Five) years of experience in the production & supply of class dredgers/class vessel. The local tenderer shall also submit proven satisfactory performance certificate of its class dredgers/class vessel which is issued by its client (s) supplied. The local tenderer must confirm that the construction of the dredgers shall be carried out as per drawing & design of a foreign reputed dredger manufacturer, being appointed as a subcontractor, having at least 20 (twenty) years' experience in manufacturing & overseas supply of class dredgers. In this regard, the experience certificate of foreign dredger manufacturer shall have to be submitted. The local tenderer shall ensure the construction of the dredger including installation of main engine, auxiliary engine, dredge pump, hydraulic system, electric system and all other systems, equipment/machinery, etc. shall be carried out under direct supervision of expatriate expert of foreign dredger manufacturer. An agreement between the local tenderer and foreign dredger manufacturer shall have to be submitted to ensure the above condition.</p>

ITT 14.1(c)	<p>The minimum supply and/or production capacity of Goods is/ are:</p> <p>The tenderer must submit a statement with layout plan to show their production/supply capacity sufficient of equal of the goods for which tender has been invited for procurement.</p>
ITT 15.1(a)	<p>The minimum amount of liquid asset or working capital or credit facility is BDT 3900.00 (Three thousand and nine hundred) million or US\$ 46.00 (Forty six) million.</p>
ITT 16.2	<p>The maximum of percentage 20 (<i>twenty</i>) of Goods & related services allowed to be subcontracted for both the local tenderer & foreign tenderer</p> <p>The local tenderer shall appoint a foreign reputed dredger manufacturer as subcontractor having following qualifications:</p> <ul style="list-style-type: none"> (a) It must have at least 20 (<i>twenty</i>) years' experience in manufacturing of class dredgers. The satisfactory completion certificate of overseas supply shall have to be submitted with the offer in support of manufacturing class dredger. (b) It shall have liquid asset or working capital or credit facility of worth Tk. 100% (hundred percent) cost of concerned subcontracting goods & related services. (c) Subcontractor must comply with the provision of ITT clause 5. For this purpose, contractor shall complete the Subcontractor's information in Form PG4-2A for submission with tender. <p>The foreign tenderer may appoint a local tenderer as subcontractor for Crane Boats having following qualifications:</p> <ul style="list-style-type: none"> (a) It must have at least 5 (<i>five</i>) years' experience in manufacturing of class dredgers/class vessel. The satisfactory completion certificate of supply shall have to be submitted with the offer in support of manufacturing class dredgers/class vessel. (b) It shall have liquid asset or working capital or credit facility of worth Tk. 100% (hundred percent) cost of concerned subcontracting goods & related services. (c) Subcontractor must comply with the provision of ITT clause 5. For this purpose contractor shall complete the Subcontractor's information in Form PG4-2A for submission with tender.
D. Preparation of Tender	
ITT 21.1(q)	<p>The Tenderer shall submit with its Tender the following additional documents:</p>

	<ul style="list-style-type: none"> i. Tender document purchase receipt (Original); ii. Attested copy of valid Trade Licence or equivalent certificate(s) as applicable in the Tenderer's Country; iii. Manufacturer's certificate (if applicable); iv. Authorization of Local Agent for foreign tenderer is mandatory. v. G.A plan of dredgers, crane boats, HDPE floating pipes, HDPE shore pipes, Foam type floaters, rubber hose pipes & ball sockets; vi. Midship section, lines plan, stability booklet & speed calculation of crane boats. vii. Brochures (Main Engine, auxiliary engine, generator, dredge pump, hydraulic pump, cutter, crane and other machinery & equipment, etc.); viii. Documentary evidences of the yard facilities, infrastructures, machineries, equipments etc; ix. A list of human resources including experienced engineers, class Welders, class Fitters, Technician etc. with at least 02 (Two) Naval Architects & 02 (two) Mechanical Engineer, who have Bachelor of Science degree in the relevant field shall be provided. x. Other documents described in ITT clause 21.1 and ITT clause 21.2 ;
ITT 22.1	Alternative tender <i>shall not be</i> permitted.
ITT 23.3	Not Applicable
ITT 23.5	No instruction other than in ITT is applicable.
ITT 23.7	The following particular item represents more than fifty percent (50%) of the estimated lot value is: <i>None</i>
ITT 23.11(c) ITT 23.12 (c) ITT 23.13 (e)	"Final destination (Project Site)": Dredger Base, BIWTA, Narayanganj, Bangladesh.
ITT 23.12 (a)	Place of Destination: Dredger Base, BIWTA, Narayanganj, Bangladesh.
ITT 23.12 (d)	In addition to the CIF/CIP price specified in ITT 23.12(a), the price of the Goods manufactured outside Bangladesh shall be quoted: Not Applicable
ITT 24.3	Name of the foreign currency: USD or GBP or EUR or JPY.
ITT 25.2(b)	Spare parts are: Required as mention in Section-7 (Technical Specification).
ITT 26.1(b)	<p>Manufacturer's Authorisation Letter is required for main engine, auxiliary engine, gear box, generator, dredge pump, cutter, crane, spare parts, HDPE shore pipe, Foam type floater, HDPE floating pipe, rubber Hose pipes & ball sockets, F.S wire ropes, Communication equipment etc.</p> <p>Manufacturer's Authorisation Letter shall be submitted from manufacturer or authorized dealer/agent/distributor of manufacturer.</p>

ITT 26.1(C)	After sales service is: The period of time that after sales service is expected to be available shall be 20 (twenty) years.
ITT 27.2	The Tender validity period shall be 180 (One Hundred & Eighty) days.
ITT 29.2	In favour of BIWTA.
ITT 29.3	The amount of the Tender Security shall be BDT 39.00 (Thirty nine) million or US\$ 460,000.00 (USD Four hundred and sixty thousand).
ITT 34.1	In addition to the original of the Tender, 1 (one) photocopy of which each page shall be numbered, signed & sealed by the Tenderer shall be submitted.
E. Submission of Tender	
ITT 35.2(c)	<p>The inner and outer envelopes shall bear the following additional identification marks:</p> <p>The tenderer shall seal the original and each copy of the tender in separate envelopes, duly marking the envelopes as “ORIGINAL” and “COPY”.</p> <p>The inner and outer envelopes shall:</p> <p>(a) bear the name and address of the Tenderer;</p> <p>(b) be addressed to the Purchaser at the address;</p> <p>(c) bear the name of the Tender and the Tender Number and bear a statement “DO NOT OPEN BEFORE 10/03/2020 at 14:30 Hours.”</p>
ITT 35.7	Tenderer shall not have the option of submitting their tender electronically.
ITT 35.8	If bidders shall have the option of submitting their bids electronically, the electronic bidding submission procedures shall be: Not Applicable.
ITT 36.1	<p>For <u>Tender submission purposes</u>, the Purchaser’s address is:</p> <p>Primary: Office of the Chief Engineer (Dredging) and Project Director, Dredging Department, BIWTA Bhaban (Level-7), 141-143 Motijheel C/A, Dhaka, Bangladesh.</p> <p>Secondary:</p> <p>(a) Office of the Divisional Commissioner, 1st 12 storied Govt. Office Bhaban, 2nd floor, Room no. 303, Segunbagicha, Dhaka, Bangladesh.</p> <p>(b) Office of the Police Commissioner, Dhaka Metropolitan Police Headquarters, Ramna, Dhaka-1000, Bangladesh.</p> <p>The deadline for submission of Tenders is 10/03/2020 upto 12:00 Hours.</p>
F. Opening and Evaluation of Tenders	
ITT 42.2	<p>The Tender opening shall take place at:</p> <p>Office of the Chief Engineer (Dredging) and Project Director, Dredging Department, BIWTA Bhaban (Level-7), 141-143 Motijheel C/A, Dhaka, Bangladesh.</p> <p>Time & Date: 14:30 Hours on 10/03/2020.</p>

ITT 42.3	If electronic tender submission is permitted as sated under ITT sub-clause 34.8, the specific tender opening procedures shall be: Not Applicable
ITT 51.1	Domestic preference shall be a tender evaluation factor.
ITT 52.5	The applicable economic factors, for the purposes of evaluation of Tenders shall be: No factor shall be allowed.
G. Award of Contract	
ITT 61.1	The maximum percentage by which quantities per item may be increased is 15% (fifteen). The maximum percentage by which quantities per item may be decreased is 15% (fifteen).
ITT 63.2	<ul style="list-style-type: none"> i. The amount of Performance Security shall be 10% (ten percent) of the Contract Price. Another security as Bank Guarantee amounting to 5% (five percent) of the Contract Price shall be provided for operation contract at the end of warranty obligation of goods which shall remain valid for another 01 (one) year. ii. The Supplier/Manufacturer shall have to submit an additional Performance Guarantee (PG) for another 01 (One) year for HDPE Shore pipe, floating pipe & Foam type floater after expiration of 01 (One) year warranty obligation. The amount of additional performance guarantee (PG) shall be 10% (ten percent) of the contract price of HDPE Shore pipe, floating pipe & Foam type floater.

Section 3. General Conditions of Contract

1. Definitions
- 1.1 The following words and expressions shall have the meaning hereby assigned to them. Boldface type is used to identify the defined term:
- (a) **Completion Schedule** means the fulfilment of the Related Services by the Supplier in accordance with the terms and conditions set forth in the Contract;
 - (b) **Contract Agreement** means the Agreement entered into between the Purchaser and the Supplier, together with the Contract Documents referred to therein, including all attachments, appendices, and all documents incorporated by reference therein;
 - (c) **Contract Documents** means the documents listed in the Contract Agreement, including any amendments thereto;
 - (d) **Contract Price** means the price stated in the Notification of Award and thereafter as adjusted in accordance with the provisions of the Contract;
 - (e) **Day** means calendar days unless otherwise specified as working days;
 - (f) **Delivery** means the transfer of ownership of the Goods from the Supplier to the Purchaser in accordance with the terms and conditions set forth in the Contract;
 - (g) **GCC** mean the General Conditions of Contract;
 - (h) **Goods** means raw materials, products and equipment and objects in solid, liquid or gaseous form, electricity, and related Services if the value of such Services does not exceed that of the Goods themselves ;
 - (i) **Government** means the Government of the People's Republic of Bangladesh;
 - (j) **Procuring Entity/Purchaser** means a Entity having administrative and financial powers to undertake Procurement of Goods, Works or Services using public funds, as specified in the PCC;
 - (k) **Related Services** means Services linked to the supply of Goods contracts.;
 - (l) **PCC** means the Particular Conditions of Contract;
 - (m) **Subcontractor** means any natural person, private or government entity, or a combination of the above, to whom any part of the Goods to be supplied or execution of any part of the Related Services is subcontracted by the Supplier;
 - (n) **Supplier** means a Person under contract with a Purchaser for the supply of Goods and related Services under the Act;
 - (o) **Site** means the point(s) of delivery named in the PCC
 - (p) **Writing** means communication written by hand or machine duly signed and includes properly authenticated messages by facsimile or electronic mail.

- (q) **Verified Report** means the report submitted by the Purchaser to the Head of the Purchaser setting forth its findings as to the existence of grounds or causes for termination and explicitly stating its recommendation for the issuance of a Notice to Terminate.
2. **Contract Documents**
- 2.1 Subject to the order of precedence set forth in the GCC Sub-Clause 5.1, all documents forming the Contract (and all parts thereof) are intended to be correlative, complementary, and mutually explanatory. The Contract Agreement shall be read as a whole.
3. **Corrupt, Fraudulent, Collusive or Coercive Practices**
- 3.1 The Government requires that Purchaser, as well as Suppliers, shall observe the highest standard of ethics during the implementation of procurement proceedings and the execution of contracts under public funds.
- 3.2 The Government requires that Procuring Entities, as well as Suppliers shall, during the execution of Contracts under public funds, ensure-
- (a) strict compliance with the provisions of Section 64 of the Public Procurement Act 2006 (Act 24 of 2006);
- (b) abiding by the code of ethics as mentioned in the Rule 127 of the Public Procurement Rules, 2008;
- (c) that neither it nor any other member of its staff or any other agents or intermediaries working on its behalf engages in any practice as detailed in GCC Sub -Clause 3.3
- 3.3 For the purpose of GCC Sub-clause 3.2 the terms –
- (a) **corrupt practice** means offering, giving or promising to give, receiving, or soliciting, either directly or indirectly, to any officer or employee of a Purchaser or other public or private authority or individual, a gratuity in any form; employment or any other thing or service of value as an inducement with respect to an act or decision or method followed by a Purchaser in connection with a Procurement proceeding or contract execution;
- (b) **fraudulent practice** means the misrepresentation or omission of facts in order to influence a decision to be taken in a Procurement proceeding or Contract execution;
- (c) **collusive practice** means a scheme or arrangement between two (2) or more Persons, with or without the knowledge of the Purchaser, that is designed to arbitrarily reduce the number of Tenders submitted or fix Tender prices at artificial, noncompetitive levels, thereby denying a Purchaser the benefits of competitive price arising from genuine and open competition; or
- (d) **coercive practice** means harming or threatening to harm, directly or indirectly, Persons or their property to influence a decision to be taken in a Procurement proceeding or the execution of a Contract, and this will include creating obstructions in the normal submission process used for Tenders.

- 3.4 Should any corrupt, fraudulent, collusive or coercive practice of any kind come to the knowledge of the Purchaser, it will, in the first place, allow the Supplier to provide an explanation and shall, take actions only when a satisfactory explanation is not received. Such exclusion and the reasons thereof, shall be recorded in the record of the procurement proceedings and promptly communicated to the Supplier concerned. Any communications between the Supplier and the Purchaser related to matters of alleged fraud or corruption shall be in writing.
- 3.5 If corrupt, fraudulent, collusive or coercive practices of any kind determined by the Purchaser against the Supplier alleged to have carried out such practices, the Purchaser shall proceed under GCC Clause 42.4
- 3.6 The Supplier shall permit the Purchaser to inspect the Supplier's accounts and records and other documents relating to the submission of the Tender and Contract performance.

4. Interpretation

- 4.1 In interpreting the GCC, singular also means plural, male also means female or neuter, and the other way around. Headings in the GCC shall not be deemed part thereof or be taken into consideration in the interpretation or construction thereof or of the Contract. Words have their normal meaning under the English language unless specifically defined.

4.2 Entire Agreement

- (a) The Contract constitutes the entire agreement between the Purchaser and the Supplier and supersedes all communications, negotiations and agreements (whether written or oral) of parties with respect thereto made prior to the date of Contract Agreement; except those stated under GCC Sub Clause 5.1(i) .

4.3 Amendment

- (a) No amendment or other variation of the Contract shall be valid unless it is in writing, is dated, expressly refers to the Contract, and is signed by a duly authorised representative of each party thereto.

4.4 Non-waiver

- (a) Subject to GCC Sub-Clause 4.4(b), no relaxation, forbearance, delay, or indulgence by either party in enforcing any of the terms and conditions of the Contract or the granting of time by either party to the other shall prejudice, affect, or restrict the rights of that party under the Contract, neither shall any waiver by either party of any breach of Contract operate as waiver of any subsequent or continuing breach of Contract.
- (b) Any waiver of a party's rights, powers, or remedies under the Contract must be in writing, dated, and signed by an authorised representative of the party granting such waiver, and must specify the right and the extent to which it is being waived.

4.5 Severability

- (a) If any provision or condition of the Contract is prohibited or rendered invalid or unenforceable, such prohibition, invalidity or

unenforceability shall not affect the validity or enforceability of any other provisions and conditions of the Contract.

- 5. Documents Forming the Contract in order of precedence**
- 5.1 The following documents forming the Contract shall be in the following order of precedence, namely :
- (a) the signed Contract Agreement;
 - (b) the Notification of Award;
 - (c) The Tender and the appendices to the Tender;
 - (d) Particular Conditions of Contract;
 - (e) General Conditions of Contract;
 - (f) Technical Specifications;
 - (g) Drawings;
 - (h) Priced Schedule and schedule of requirements and ;
 - (i) Other Documents including correspondences listed in the PCC forming part of the Contract.
- 6. Eligibility**
- 6.1 The Supplier and its Subcontractors shall have the nationality of an eligible country. A Supplier or Subcontractor shall be deemed to have the nationality of a country if it is a citizen or constituted, incorporated, or registered, and operates in conformity with the provisions of the laws of that country.
- 6.2 All Goods and Related Services to be supplied under the Contract shall have their origin in Eligible Countries.
- 6.3 For the purpose of the GCC Clause 6.2, origin means the country where the goods have been grown, mined, cultivated, produced, manufactured, or processed; or through manufacture, processing, or assembly, another commercially recognized article results that differs substantially in its basic characteristics from its components.
- 7. Governing Language**
- 7.1 The Contract shall be written in English language. Correspondence and documents relating to the Contract exchanged by the Supplier and the Purchaser shall be written in English .Supporting documents and printed literature that are part of the Contract may be in another language provided they are accompanied by an accurate translation of the relevant passages in English language, in which case, for purposes of interpretation of the Contract, this translation shall govern.
- 7.2 The Supplier shall bear all costs of translation to the governing language and all risks of the accuracy of such translation.
- 8. Governing Law**
- 8.1 The Contract shall be governed by and interpreted in accordance with the laws of the People’s Republic of Bangladesh.
- 9. No fees/Gratuities**
- 9.1 No fees, gratuities, rebates, gifts, commissions or other payments, other than those shown in the Tender or the contract, shall be given or received in connection with the procurement process or in the contract execution.

- 10. Use of Contract Documents & Information**
- 10.1 The Supplier shall not, except for purposes of performing the obligations in this Contract, without the Purchaser's prior written consent, disclose this Contract, or any provision thereof, or any specification, plan, drawing, pattern, sample, or information furnished by or on behalf of the Purchaser. Any such disclosure shall be made in confidence and shall extend only as far as may be necessary for purposes of such performance.
- 10.2 Any document, other than this Contract itself, enumerated in GCC Clause 10.1 shall remain the property of the Purchaser and shall be returned (all copies) to the Purchaser on completion of the Supplier's performance under this Contract if so required by the Purchaser.
- 11. Communications & Notices**
- 11.1 Communications between Parties (notice, request or consent required or permitted to be given or made by one party to the other) pursuant to the Contract shall be in writing to the addresses specified in the PCC.
- 11.2 A notice shall be effective when delivered or on the notice's effective date, whichever is later.
- 11.3 A Party may change its address for notice hereunder by giving the other Party notice of such change to the address.
- 12. Trademark, Patent and Intellectual Property Rights**
- 12.1 The Purchaser should not be liable for any infringement of intellectual property rights arising from use of the goods procured. In case there are third-party claims of such infringement of patent, trademark, or industrial design rights, the supplier must indemnify and hold the Purchaser free and harmless against such claims and shall not be in contravention of **The Trademark Act, 2009 and The Patents and Designs Act, 1911.**
- 13. Copyright**
- 13.1 The copyright in all drawings, documents, and other materials containing data and information furnished to the Purchaser by the Supplier herein shall remain vested in the Supplier, or, if they are furnished to the Purchaser directly or through the Supplier by any third party, including suppliers of materials, the copyright in such materials shall remain vested in such third party.
- 14. Assignment**
- 14.1 The Supplier shall not assign his rights or obligations under the Contract, in whole or in part, except with the Purchaser's prior written consent.
- 15. Sub contracting**
- 15.1 Any subcontracting arrangements made during contract implementation and not disclosed at the time of the Tendering shall not be allowed.
- 15.2 Subcontracting of any portion of the Goods shall not relieve the Tenderer from any liability or obligations that may arise from its performance.
- 15.3 Supplier shall retain full responsibility for the contract and can not pass any contractual obligations to the subcontractor and under no circumstances assignment of the contract to the subcontractor be allowed.
- 15.4 Subcontractors shall comply with the provisions of GCC Clause 3 and 6.

- 16. Supplier's Responsibilities**
- 16.1 The Supplier shall supply all the Goods and Related Services specified in the Scope of Supply as stated under GCC Clause 18 and the Delivery and Completion schedule, as stated under GCC Clauses 23 and 24 in conformity with the provisions of the Contract Agreement.
- 17. Purchaser's Responsibilities**
- 17.1 Whenever the performance of the obligations in this Contract requires that the Supplier obtain permits, approvals and other license from local public authorities, the Purchaser may, if so needed by the Supplier, make its best effort to assist the Supplier in complying with such requirements in a timely and expeditious manner. However, the supplier shall bear the costs of such permits and/or licenses. On the other hand, the Purchaser shall pay all costs involved in the performance of its responsibilities, in accordance with the contract.
- 17.2 The Purchaser shall pay the Supplier, in consideration of the provision of Goods and Related Services, the Contract Price under the provisions of the Contract at the times and manner prescribed in the Contract Agreement.
- 18. Scope of Supply**
- 18.1 Subject to the PCC, the Goods and Related Services to be supplied shall be as specified in Section 6: Schedule of Requirements.
- 18.2 Unless otherwise stipulated in the Contract, the Scope of Supply shall include all such items not specifically mentioned in the Contract but that can be reasonably inferred from the Contract as being required for attaining Delivery and Completion of the Goods and Related Services as if such items were expressly mentioned in the Contract.
- 19. Amendment to Order**
- 19.1 The Purchaser may make an amendment to Order for necessary adjustment within the general scope of the contract in any one or more of the following aspects in order to fully meet the requirement of the Contract:
- (a) Drawing, design or specifications of the goods, provided that:
 - i. The goods to be furnished are to be specifically manufactured for the government in accordance therewith;
 - ii. The change is an improvement of the goods and advantageous to the Government;
 - iii. It is done at no extra cost; and
 - iv. It is not prejudicial to the losing Tenderers in the sense that such change/s could not have been foreseen during the conduct of the tendering and would have significantly affected the other tenderer's tender;
 - (b) The place of delivery;
 - (c) The place of performance of the services;
 - (d) Additional items needed and necessary for the protection of the goods procured, which were not included in the original contract.
- 19.2 Such amendment may or may not result to an increase or a decrease of the contract price, and/or an extension or reduction of the delivery period. However, the amendment should not have the result of changing the subject matter of the contract or the specifications of the goods or services, in any material aspect and to such an extent that, if introduced during the Tendering stage, may have had a significant effect on other Tenderer's tender, because this situation would actually require another tendering activity.

- 20. Instances When Amendment to Order May be Issued**
- 20.1 The Purchaser may issue amendments order at any time during contract implementation, through a notice as stated under GCC Clause 11, provided that such adjustment is required to fully meet the requirements of the contract. Any of the following circumstances may serve as basis for such amendment/s:
- (a) Emergency cases, fortuitous events or unforeseen contingencies arising during contract implementation, and such contingencies have an impact on the procurement at hand, such as:
 - i. Changes in the conditions affecting the contract, e.g., a change in the place of delivery;
 - ii. Time is of the essence in the implementation of the contract, and any changes require immediate implementation; and
 - iii. Additional requirements have been identified as necessary for the protection of the goods procured, such as changes in the packaging of the goods, or additional items have become necessary to ensure that the goods are sufficiently protected from the elements;
 - (b) When the contract does not reflect the real intention of the parties due to mistake or accident, and the amendment is necessary to reflect the party's intention; and
 - (c) Other analogous circumstances that could affect the conditions of the procurement at hand
- 21. Adjustments in Contract Price and/or Delivery Schedule in Amendment to Order**
- 21.1 If an amendment to order increases or decreases the cost of ,or the time required for executing any part of the delivery under the original contract, an equitable adjustment in contract price and/or delivery schedule should be mutually agreed upon between parties concerned, and the contract should be modified as stated under GCC Clause 46
- 21.2 If the amendment to order consists of additional items, the price adjustment shall be based on the unit price in the original contract for items of goods similar to those in the original contract. If the contract does not contain any rate applicable to the additional items, then suitable prices shall be mutually agreed upon between the parties, based on prevailing market prices.
- 21.3 It is required, however, that any increase in contract price must not exceed ten percent (10%) of the original contract price.
- 22. Packing and Documents**
- 22.1 The Supplier shall provide such packing of the goods as is required to prevent their damage or deterioration during transit to their final destination, as indicated in the Contract and in accordance with existing industry standards. The packing shall be sufficient to withstand, without limitation, rough handling and exposure to extreme temperatures, salt and precipitation, and open storage. Packing case size and weights shall take into consideration, where appropriate, the remoteness of the goods' final destination and the absence of heavy handling facilities at all points in transit.
- 22.2 The packing, marking, and documentation within and outside the packages shall comply strictly with such special requirements as shall be expressly provided for in the Contract as stated under GCC Clause

22.1, including additional requirements, if any, specified in the PCC, and in any subsequent instructions ordered by the Purchaser.

22.3 The outer packaging must contain a "Packing List" which must reflect the actual contents of the package.

23. Delivery and Documents

23.1 Subject to GCC Sub-Clause 19, the Delivery of the Goods and completion of the Related Services shall be in accordance with the Delivery and Completion Schedule specified in the Section 6: Schedule of Requirements.

23.2 The details of shipping and other documents to be furnished by the Supplier shall be specified in the PCC, and shall be received by the Purchaser at least one week before arrival of the Goods and, if not received the Supplier shall be responsible for consequent expenses.

24. Acceptance

24.1 Acceptance by the Purchaser shall be completed not later than fourteen (14) days from receipt of the goods at final destination in the form of an **Acceptance Certificate**, unless any defects in the supply, any damage during transportation or any failure to meet the required performance criteria of the supply are identified and reported to the Supplier as stated under GCC Clause 31 and GCC Clause 32. In such cases the Acceptance Certificate will be issued only for those parts of the contract supplies which are accepted. The Acceptance Certificate for the remaining supplies will only be issued after the Supplier has remedied the defects and/or any non-conformity under GCC Clause 31 and GCC Clause 32.

24.2 The appropriate Technical Inspection and Acceptance Committee of the Purchaser must commence the inspection and acceptance process within two (2) days from delivery of the goods, and shall complete the same as soon as practicable.

25. Contract Price

25.1 The Contract Price shall be specified in the PCC.

25.2 During evaluation, tender has excluded and not taken into account:

(a) In the case of Goods manufactured in Bangladesh, VAT payable on account of Supplier, which will be payable on the goods if a contract is awarded to the Tenderer;

(b) in the case of Goods manufactured outside the Bangladesh, already imported or to be imported, customs duties, import VAT and other import taxes levied on the imported Good, VAT, which will be payable on the Goods if the contract is awarded to the Tenderer.

25.3 The Contract price will include all the costs paid or payable as stated under GCC Clause 25.2.

25.4 Prices charged by the Supplier for the Goods delivered and the Related Services performed under the Contract shall not vary from the price as stated under GCC Sub-Clause 25.1, with the exception of any change in price resulting from a Change Order issued under GCC Clause 19.

- 26. Transportation**
- 26.1 The Supplier is required under the Contract to transport the Goods to a specified place of destination as specified in Section 6: Schedule of Requirements, defined as the Site, transport to such place of destination, including insurance, other incidental costs, and temporary storage, if any. These costs shall be included in the Contract Price.
- 26.2 If not in accordance GCC Clause 26.1, responsibility for transportation of the Goods shall be as specified in the **INCOTERM** indicated in the Price Schedule or any other trade terms specify the responsibilities of the Purchaser and Supplier as specified in PCC.
- 27. Terms of Payment**
- 27.1 The Contract Price, including any Advance Payments, if applicable, shall be paid in the manner as specified in the PCC.
- 27.2 The Supplier's request for payment shall be made to the Purchaser in writing, accompanied by an invoice describing, as appropriate, the Goods delivered and Related Services performed, and accompanied by the documents as stated under GCC Clause 23 and 24 and upon fulfilment of any other obligations stipulated in the Contract.
- 27.3 Payments shall be made promptly by the Purchaser, but in no case later than the days indicated in the PCC after submission of an invoice or request for payment by the Supplier, and after the Purchaser has accepted it.
- 27.4 The currencies in which payments shall be made to the Supplier under this Contract shall be those in which the tender price is expressed.
- 27.5 In the event that the Purchaser fails to pay the Supplier any payment by its respective due date or within the period set forth in the PCC, the Purchaser shall pay to the Supplier interest on the amount of such delayed payment at the rate shown in the PCC, for the period of delay until payment has been made in full, whether before or after judgment or arbitration award.
- 28. Insurance**
- 28.1 The Goods supplied under this Contract shall be fully insured by the Supplier in a freely convertible currency against loss or damage incidental to manufacture or acquisition, transportation, storage, and delivery. The Goods remain at the risk and title of the Supplier until their final acceptance by the Purchaser.
- 28.2 If not in accordance GCC Clause 28.1, the insurance coverage shall be as specified in the **INCOTERM** indicated in the Price Schedule or any other insurance provisions as specified in PCC.
- 29. Taxes and Duties**
- 29.1 For Goods Manufactured within Bangladesh, the Supplier shall be entirely responsible for all taxes, duties, VAT, license fees, and other such levies imposed or incurred until delivery of the contracted goods to the Purchaser.
- 29.2 For Goods manufactured outside Bangladesh, the Supplier shall be entirely responsible for all taxes, duties and other such levies imposed outside Bangladesh.
- 29.3 If any tax exemptions, reductions, allowances or privileges may be available to the Supplier in Bangladesh, the Purchaser shall use its best efforts to enable the Supplier to benefit from any such tax savings to the maximum allowable extent.

30. Performance Security

- 30.1 The proceeds of the Performance Security shall be payable to the Purchaser as compensation for any loss resulting from the Supplier's failure to complete its obligations under the Contract.
- 30.2 The Performance Security shall be discharged by the Purchaser and returned to the Supplier not later than Thirty (30) days following the date of Completion of the Supplier's performance obligations under the Contract and the issuance of certification to that effect by the Purchaser, including any warranty obligations as stated under GCC Clause 33, provided that there are no claims filed against the supplier.

31. Specifications and Standards

- 31.1 The Goods and Related Services supplied under this Contract shall conform to the technical specifications and standards mentioned in Section 7, Technical Specification and in Section 8, Drawings, if any.
- 31.2 If there is no applicable standard, the goods must conform to the authoritative standards appropriate to the good's country of origin. Such standards must be the latest issued by the concerned institution.
- 31.3 Subject to the GCC Clause 19, the Supplier shall be entitled to disclaim responsibility for any design, data, drawing, specification or other document, or any modification thereof provided or designed by or on behalf of the Purchaser, by giving a notice of such disclaimer to the Purchaser.
- 31.4 Wherever references are made in the Contract to codes and standards in accordance with which it shall be executed, the edition or the revised version of such codes and standards shall be those specified in the Technical Specification. During Contract execution, any changes in any such codes and standards shall be applied only after approval by the Purchaser and shall be treated under GCC Clause 19.

32. Inspections and Tests

- 32.1 The Purchaser shall have the right to test the Goods to confirm their conformity to the Contract specifications. The PCC and Technical specifications shall specify what tests the Purchaser requires and where they are to be conducted. The supplier shall at its own expense and at no cost to the Purchaser, carry out all such tests of the Goods and related services as are specified in the Contract.
- 32.2 The Supplier shall provide the Purchaser with a report of the results of any such test.
- 32.3 The Purchaser may engage external agents for the purpose of conducting inspection or pre-shipment inspection of Goods, provided that the Purchaser shall bear all of its costs and expenses.
- 32.4 The Purchaser or its designated representative as specified shall be entitled to attend the tests and/or inspections under GCC Clause 32.1, provided that the Purchaser shall bear all of its own costs and expenses incurred in connection with such attendance.
- 32.5 Whenever the Supplier is ready to carry out any such test and inspection, it shall give a reasonable advance notice, including the place and time, to the Purchaser. The Supplier shall obtain from any relevant third party or manufacturer any necessary permission or consent to enable the Purchaser or its designated representative to attend the test and/or inspection.

- 32.6 The Purchaser may require the Supplier to carry out any test and/or inspection not required by the Contract, but deemed necessary to verify that the characteristics and performance of the Goods comply with the technical specifications, codes and standards under the Contract, provided that the Supplier's reasonable costs and expenses incurred in the carrying out of such test and/or inspection shall be added to the Contract Price. Further, if such test and/or inspection impede the progress of manufacturing and/or the Supplier's performance of its other obligations under the Contract, due allowance will be made in respect of the Delivery Dates and Completion Dates and the other obligations so affected.
- 32.7 The Purchaser may reject any Goods or any part thereof that fail to pass any test and/or inspection or do not conform to the specifications. The Supplier shall either rectify or replace such rejected Goods or parts thereof or make alterations necessary to meet the specifications at no cost to the Purchaser, and shall repeat the test and/or inspection, at no cost to the Purchaser, upon giving a notice under GCC Sub-Clause 32.5.
- 32.8 The Supplier agrees that neither the execution of a test and/or inspection of the Goods or any part thereof, nor the attendance by the Purchaser or its representative, nor the issue of any report as stated under GCC Sub-Clause 32.2, shall relieve the Supplier from any warranties or other obligations under the Contract.

33. Warranty

- 33.1 The Supplier warrants that all the Goods supplied under the Contract are new, unused, and of the most recent or current models, and that they incorporate all recent improvements in design and materials, except when the design and/or material required by the Purchaser provides otherwise under GCC Clause 19.
- 33.2 The Supplier further warrants that the all Goods supplied under this Contract shall have no defect, arising from design, materials, or workmanship or from any act or omission of the Supplier that may develop under normal use of the supplied Goods in the conditions prevailing in Bangladesh.
- 33.3 In order to assure that manufacturing defects shall be corrected by the Supplier, manufacturer, or distributor, as the case may be, a warranty shall be required from the Supplier for a minimum period of three (3) months in the case of supplies, and one (1) year in the case of equipment, or other such period as may be specified in the PCC, after the Goods, or any portion thereof as the case may be, have been delivered to and accepted in the form of an **Acceptance Certificate** as indicated in the GCC Clause 24.1 at the final destination indicated in the PCC
- 33.4 The warranty periods may vary among the various items and lots. The warranty for Goods delivered ahead will lapse earlier than the succeeding deliveries.
- 33.5 The Purchaser shall promptly notify the Supplier in writing of any claims arising under this warranty.
- 33.6 Upon receipt of such notice, the Supplier shall, within the period specified in the PCC, expeditiously repair or replace the defective Goods or parts thereof, at no cost to the Purchaser.

- 33.7 If the Supplier, having been notified, fails to remedy the defect(s) within the period as stated under GCC Sub Clause 33.6, the Purchaser may proceed to call upon the Performance security without prejudice to any other rights which the Purchaser may have against the Supplier under the Contract and under the applicable law.
- 33.8 Performance Security under GCC Clause no 30 shall only be released after the lapse of the warranty period, provided that the goods supplied are free from patent and latent defects and all the conditions imposed under the contract have been fully met.
 - (a) A patent defect, which is one that is apparent to the buyer on normal observation. It is an apparent or obvious defect.
 - i. For example, a ball pen that does not write is patently defective.
 - (b) A latent defect, which is one that is not apparent to the buyer by reasonable observation. A latent defect is "hidden" or one that is not immediately determinable.
 - i. For example, a ball pen that writes .75 kilometres instead of the expected 1.5 kilometres, has a latent defect.

34. Delays in Delivery and Extensions of Time

- 34.1 The Supplier must deliver the Goods or perform the services procured within the period prescribed by the Purchaser, as specified in the Contract.
- 34.2 If at any time during performance of the Contract, the Supplier or its subcontractors should encounter conditions impeding timely delivery of the Goods or completion of Related Services as stated under GCC Clause 23, the Supplier shall promptly notify the Purchaser in writing. It must state therein the cause/s and duration of the expected delay. The Purchaser shall decide whether and by how much to extend the time. In all cases, the request for extension should be submitted before the lapse of the original delivery date.
- 34.3 Within twenty-one (21) days of receipt of the Supplier's notice, the Purchaser shall evaluate the situation and may grant time extensions, if based on justifiable grounds, without liquidated damages.
- 34.4 The Procuring may extend up to twenty percent (20%) of the original contract time, above 20% of the original contract time approval of Head of Purchaser (HOPE) shall be required, in which case the extension shall be ratified by the Parties by amendment of the Contract as stated under GCC Clause 46.
- 34.5 Except in the case of Force Majeure, as provided under GCC Clause 38, a delay by the Supplier in the performance of its Delivery and Completion obligations shall render the Supplier liable to the imposition of liquidated damages as stated under GCC Clause 35, unless an extension of time is agreed upon, under GCC Sub-Clause 34.3.

35. Liquidated Damages

- 35.1 Subject to GCC Clause 34 and 38, if the , if the Supplier fails to deliver any or all of the Goods by the Date(s) of delivery and/or perform the Related Services within the period specified in the Contract as stated under GCC Clause 23, the Purchaser shall, without prejudice to all its other remedies under the Contract, deduct from the Contract Price, as liquidated damages, a sum equivalent to the percentage specified in the PCC of the Contract price of the delayed Goods or unperformed /

Related Services for each week or part thereof of delay until actual delivery or performance, up to a maximum deduction of the percentage specified in those PCC. Once the maximum is reached, the Purchaser may terminate the Contract as stated under GCC Clause 42.

36. Limitation of Liability

36.1 Except in cases of criminal negligence or wilful misconduct, and in the case of infringement of patent and intellectual property rights, if applicable, the Supplier shall not be liable to the Purchaser, whether in contract, tort, or otherwise, for any indirect or consequential loss or damage, loss of use, loss of production, or loss of profits or interest costs, the aggregate liability of the Supplier to the Purchaser shall not exceed the total Contract Price, provided that this limitation shall not apply, to the cost of repairing or replacing defective equipment or, to any obligation of the Supplier to pay liquidated damages to the Purchaser.

37. Change in Laws and Regulations

37.1 Unless otherwise specified in the Contract, if after the Contract, any law, regulation, ordinance, order or bylaw having the force of law is enacted, promulgated, abrogated, or changed in Bangladesh (which shall be deemed to include any change in interpretation or application by the competent authorities) that subsequently affects the Delivery Date and/or the Contract Price, then such Delivery Date and/or Contract Price shall be correspondingly increased or decreased, to the extent that the Supplier has thereby been affected in the performance of any of its obligations under the Contract.

38. Definition of Force Majeure

38.1 In this Clause, "Force Majeure" means an exceptional event or circumstance:

- (a) which is beyond a Party's control;
- (b) which such Party could not reasonably have provided against before entering into the Contract;
- (c) which, having arisen, such Party could not reasonably have avoided or overcome; and
- (d) which is not substantially attributable to the other Party.

38.2 Force Majeure may include, but is not limited to, exceptional events or circumstances of the kind listed below, so long as conditions (a) to (d) above are satisfied:

- (i) war, hostilities (whether war be declared or not), invasion, act of foreign enemies;
- (ii) rebellion, terrorism, sabotage by persons other than the Contractor's Personnel, revolution, insurrection, military or usurped power, or civil war;
- (iii) riot, commotion, disorder, strike or lockout by persons other than the Contractor's Personnel;
- (iv) munitions of war, explosive materials, ionising radiation or contamination by radio-activity, except as may be attributable to the Contractor's use of such munitions, explosives, radiation or radio-activity, and
- (v) natural catastrophes such as cyclone, hurricane, typhoon, tsunami, storm surge, floods, earthquake, landslides, fires, epidemics, quarantine restrictions, or volcanic activity;
- (vi) freight embargoes;

(vii) acts of the Government in its sovereign capacity.

39. Notice of Force Majeure

- 39.1 If a Party is or will be prevented from performing its substantial obligations under the Contract by Force Majeure, then it shall give notice to the other Party of the event or circumstances constituting the Force Majeure and shall specify the obligations, the performance of which is or will be prevented. The notice shall be given within 14 days after the Party became aware, or should have become aware, of the relevant event or circumstance constituting Force Majeure.
- 39.2 The Party shall, having given notice, be excused performance of its obligations for so long as such Force Majeure prevents it from performing them.
- 39.3 Notwithstanding any other provision of this Clause, Force Majeure shall not apply to obligations of either Party to make payments to the other Party under the Contract.

40. Duty to Minimise Delay

- 40.1 Each Party shall at all times use all reasonable endeavours to minimise any delay in the performance of the Contract as a result of Force Majeure.
- 40.2 A Party shall give notice to the other Party when it ceases to be affected by the Force Majeure.

41. Consequences of Force Majeure

- 41.1 The Supplier shall not be liable for forfeiture of its Performance Security, liquidated damages, or termination for default if and to the extent that its delay in performance or other failure to perform its obligations under the Contract is the result of an event of Force Majeure.
- 41.2 The Purchaser may suspend the delivery or contract implementation, wholly or partly, by written order for a certain period of time, as it deems necessary due to force majeure as defined in the contract.
- 41.3 Delivery made either upon the lifting or the expiration of the suspension order. However, if the Purchaser terminates the contract as stated under GCC clause 42, resumption of delivery cannot be done.
- 41.4 Head of Purchaser determines the existence of a force majeure that will be basis of the issuance of suspension of order.
- 41.5 Adjustments in the delivery or contract schedule and/or contract price, Including any need to modify contract under GCC Clause 46.

42. Termination for Default

- 42.1 The Purchaser shall terminate this Contract for default when any of the following conditions attends its implementation:
- (a) Outside of force majeure, the Supplier fails to deliver or perform any or all of the GOODS within the period(s) specified in the contract, or within any extension thereof granted by the Purchaser pursuant to a request made by the Supplier prior to the delay;
 - (b) As a result of force majeure, the Supplier is unable to deliver or perform any or all of the GOODS, amounting to at least ten

percent (10%) of the contract price, for a period of not less than sixty (60) calendar days after receipt of the notice from the Purchaser stating that the circumstance of force majeure is deemed to have ceased; or

- (c) The Supplier fails to perform any other obligation under the Contract;
- (d) If the Supplier, in the judgment of the Purchaser has engaged in corrupt, fraudulent, collusive or coercive practices, as stated under GCC Clause 3, in competing for or in executing the Contract;
- (e) When deductible amount due to liquidated damage reaches its maximum as stated under GCC Clause 35.

42.2 Termination of a contract for default is without prejudice to other remedies available to the Purchaser for breach of contract, such as payment of liquidated and other damages, if there are grounds for the latter.

42.3 In the event the Purchaser terminates the Contract in whole or in part, as stated under GCC Clause 42.1, the Purchaser may procure, upon such terms and in such manner as it deems appropriate, Goods or Related Services similar to those undelivered or not performed, and the Supplier shall be liable to the Purchaser for any additional costs for such similar Goods or Related Services. However, the Supplier shall continue performance of the Contract to the extent not terminated.

- 42.4 In the event as stated under GCC Clause 42.1(d), the Purchaser shall,
- (a) terminate the Supplier's employment under the Contract and cancel the contract, after giving 14 days' notice to the Supplier and the provisions of Clause 42 shall apply as if such expulsion had been made under Sub-Clause 42.1
 - (b) declare, at its discretion, the concerned Person to be ineligible to participate in further Procurement proceedings, either indefinitely or for a specific period of time.

43. Termination for insolvency

43.1 The Purchaser shall terminate this Contract if the Supplier is declared bankrupt or insolvent as determined with finality by a court of competent jurisdiction. In this event, termination will be without compensation to the Supplier, provided that such termination will not prejudice or affect any right of action or remedy which has accrued or will accrue thereafter to the Purchaser and/or the Supplier.

44. Termination for Convenience

44.1 The Purchaser, by written notice sent to the supplier, may terminate this Contract, in whole or in part, at any time for its convenience. The notice of termination shall specify that the termination is for the Purchaser's convenience, the extent to which performance of the supplier under the contract is terminated, and the date upon which such termination becomes effective.

44.2 Any of the following circumstances may constitute sufficient grounds to terminate a contract for conveniences :

- (a) If Physical and economic conditions have significantly changed so as to render the contract no longer economically, financially or technically feasible, as determined by the Head of Purchaser;
- (b) The Head of Purchaser has determined the existences of conditions that make contract implementation impractical and/or unnecessary, such as, but not limited to , fortuitous event/s, change in laws and government policies;
- (c) Funding for the contract has been withheld or reduced;
- (d) Any circumstances analogous to the foregoing.

44.3 The GOODS that have been delivered and/or performed or are ready for delivery or performance within thirty (30) calendar days after the Supplier's receipt of Notice to Terminate shall be accepted by the Purchaser at the contract terms and prices. For GOODS not yet performed and/or ready for delivery, the Purchaser may elect:

- (a) to have any portion delivered and/or performed and paid at the contract terms and prices; and/or
- (b) to cancel the remainder and pay to the Supplier an agreed amount for partially completed and/or performed goods and for materials and parts previously procured by the Supplier.

45. Procedures for Termination of Contracts

45.1 The following provisions shall govern the procedures for termination of this Contract as stated under GCC Clauses 42,43 and 44:

- (a) Upon receipt of a written report of acts or causes which may constitute ground(s) for termination as aforementioned, or upon its own initiative, the Purchaser shall, within a period of seven (7) calendar days, verify the existence of such ground(s) and cause the execution of a Verified Report, with all relevant evidence attached;
- (b) Upon recommendation by the Purchaser, the Head of the Purchaser shall terminate this Contract only by a written notice to the Supplier conveying the termination of this Contract. The notice shall state:
 - i. that this Contract is being terminated for any of the ground(s) afore-mentioned, and a statement of the acts that constitute the ground(s) constituting the same;
 - ii. the extent of termination, whether in whole or in part;
 - iii. an instruction to the Supplier to show cause as to why this Contract should not be terminated; and
 - iv. special instructions of the Purchaser, if any.
- (c) The Notice to Terminate shall be accompanied by a copy of the Verified Report;

- (d) Within a period of seven (7) calendar days from receipt of the Notice of Termination, the Supplier shall submit to the Head of the Purchaser a verified position paper stating why this Contract should not be terminated. If the Supplier fails to show cause after the lapse of the seven (7) day period, either by inaction or by default, the Head of the Purchaser shall issue an order terminating this Contract;
- (e) The Purchaser may, at any time before receipt of the Supplier's verified position paper, withdraw the Notice to Terminate if it is determined that certain items or works subject of the notice had been completed, delivered, or performed before the Supplier's receipt of the notice;
- (f) Within a non-extendible period of ten (10) calendar days from receipt of the verified position paper, the Head of the Purchaser shall decide whether or not to terminate this Contract. It shall serve a written notice to the Supplier of its decision and, unless otherwise provided, this Contract is deemed terminated from receipt of the Supplier of the notice of decision. The termination shall only be based on the ground(s) stated in the Notice to Terminate; and
- (g) The Head of the Purchaser may create a Contract Termination Review Committee (CTRC) to assist him in the discharge of this function. All decisions recommended by the CTRC shall be subject to the approval of the Head of the Purchaser.

46. Contract Amendment

- 46.1 Subject to applicable laws, no variation in or modification of the terms of this Contract shall be made except by written amendment signed by the parties.
- 46.2 The Purchaser, in accordance with their Delegation of Financial Powers, as required, may amend the Contract to reflect the changes introduced to the Original terms and Conditions of the Contract.

47. Settlement of Disputes

47.1 **Amicable Settlement:**

- (a) The Purchaser and the Supplier shall use their best efforts to settle amicably all disputes arising out of or in connection with this Contract or its interpretation.

47.2 **Adjudication**

- (a) If the Supplier /Purchaser believe that amicable settlement of dispute is not possible between the two parties, the dispute shall be referred to the Adjudicator within fourteen (14) days of first written correspondence on the matter of disagreement;
- (b) The Adjudicator named in the PCC is jointly appointed by the parties. In case of disagreement between the parties, the Appointing Authority designated in the PCC shall appoint the Adjudicator within fourteen (14) days of receipt of a request from either party;
- (c) The Adjudicator shall give its decision in writing to both parties within twenty-eight (28) days of a dispute being referred to it;

- (d) The supplier shall make all payments (fees and reimbursable expenses) to the Adjudicator, and the Purchaser shall reimburse half of these fees through the regular progress payments;
- (e) Should the Adjudicator resign or die, or should the Purchaser and the Supplier agree that the Adjudicator is not functioning in accordance with the provisions of the Contract; a new Adjudicator will be jointly appointed by the Purchaser and the Supplier. In case of disagreement between the Purchaser and the Supplier the Adjudicator shall be designated by the Appointing Authority designated in the PCC at the request of either party, within fourteen (14) days of receipt of a request from either party.

47.3 **Arbitration**

- (a) If the Parties are unable to reach a settlement under GCC Clause 47.1(a) within twenty-eight (28) days of the first written correspondence on the matter of disagreement, then either Party may give notice to the other party of its intention to commence arbitration in accordance with GCC Sub-Clause 47.3(b);
- (b) The arbitration shall be conducted in accordance with the rules of procedure specified in the PCC.

Section 4. Particular Conditions of Contract

<i>Instructions for completing the Particular Conditions of Contract are provided, as needed, in the notes in italics mentioned for the relevant GCC clauses.</i>	
GCC Clause	Amendments of, and Supplements to, Clauses in the General Conditions of Contract
GCC 1.1(j)	The Purchaser is Chairman, BIWTA, BIWTA Bhaban (Level-6), 141-143 Motijheel C/A, Dhaka-1000, Bangladesh
GCC 1.1(o)	The site(s)/ point(s) of delivery is/are: Dredger Base, BIWTA, Narayanganj, Bangladesh.
GCC 5.1(i)	The following documents shall also be part of the Contract: 1. Tender Submission Letter 2. Copy of Bank Guarantee for Performance Security
GCC 11.1	<p>For <u>notices</u>, the Purchaser's contact details shall be: Attention: Chief Engineer (Dredging) and Project Director Address: Dredging Department, BIWTA Bhaban (Level-7), 141-143, Motijheel C/A, Dhaka-1000, Bangladesh. Telephone: +88-02-9552127 Facsimile number: +88-02-9551072, +88-02-9552127 Electronic mail address: mamatin77@gmail.com</p> <p>For <u>notices</u>, the Supplier's contact details shall be: Attention: Address: Telephone: Facsimile number: Electronic mail address:</p>

GCC 18.1

The scope of Supply shall be defined in:

Item No.	Description of Item	Unit of Supply	Qty.
1.	28" Cutter Suction Dredger	Nos.	02
2.	HDPE Floating Pipe for 28" Cutter Suction Dredger	meter	3000
3.	Foam type floater for 28" Cutter Suction Dredger	Nos.	1000
4.	HDPE Shore Pipe for 28" Cutter Suction Dredger	meter	5000
5.	Ball Socket for 28" Cutter Suction Dredger	Pairs	80
6.	Rubber Hose Pipe for 28" Cutter Suction Dredger	Nos.	150
7.	Spare parts for 28" Cutter Suction Dredgers	L.S	-
8.	Crane Boat for 28" Cutter Suction Dredger	Nos.	02
9.	Spare Parts for Crane Boat of 28" Cutter Suction Dredger	L.S	-
10.	F. S Wire Rope (Different sizes) (each coil 300 m)	Coil	100

GCC 22.2

The packing, marking and documentation within and outside the packages shall be:

A packing list indicating the content of each package, shall be enclosed in a water proof envelope and shall be secured to the outside of the packing case. All materials used for packing shall be environmentally neutral.

In addition, each package shall be clearly marked with indelible ink/paint in bold letters on four sides, with the following:

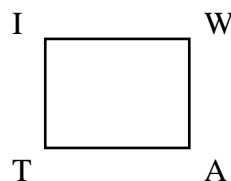

The outer packing may be clearly marked on at least four sides as follows:

- (a) Name and address of the Purchaser;
- (b) Name of the Supplier;
- (c) Contract Description;
- (d) Final Destination/Delivery Point;
- (e) Gross weight;
- (f) Package number of total number of packages;

	<p>(g) Brief description of the content;</p> <p>(h) Special lifting instructions, if any.</p> <p>(i) <i>Special handling instructions, if any.</i></p>
GCC 23.2	<p>Details of shipping and documents to be furnished by the Supplier shall be:</p> <p><u>“For Goods supplied from abroad as per INCOTERM CIF or CIP:</u></p> <p>Upon shipment, the Supplier shall notify the Purchaser and the Insurance Company by telex or fax the full details of the shipment, including Contract number, description of Goods, quantity, the vessel, the bill of lading number and date, port of loading, date of shipment, port of discharge, etc. The Supplier shall send the following documents to the Purchaser, with a copy to the Insurance Company:</p> <ul style="list-style-type: none"> (a) 6 (six) copies of the Supplier’s invoice showing the description of the Goods, quantity, unit price, and total amount (including freight and insurance);; (b) Original and 6 (six) copies of the negotiable, clean, on-board bill of lading marked “freight prepaid” and 6 (six) copies of non-negotiable bill of lading; (c) 6 (six) copies of the packing list identifying contents of each package; (d) Insurance certificate-- 3 copies; (e) Manufacturer’s or Supplier’s warranty certificate-3 copies; (f) Inspection certificate, issued by the nominated inspection agency and the Supplier’s factory inspection report (if applicable)-3 copies; (g) Certificate of origin-6 copies. (h) Operation, Maintenance Manual & Parts Catalogue of dredgers, crane boats and installed engines & equipment as built drawings – 4 copies <p>The Purchaser shall receive the above documents at least one week before arrival of the goods at the port or place of arrival and, if not received, the Supplier will be responsible for any consequent expenses.</p>
	<p>For Goods from within the Purchaser’s country as per INCOTERM EXW:</p> <p>Upon delivery of the Goods to the transporter, the Supplier shall notify the Purchaser and send the following documents to the Purchaser:</p> <ul style="list-style-type: none"> (a) 6 (six) copies of the Supplier’s invoice showing the description of the Goods, quantity, unit price, and total amount; (b) Delivery note, railway receipt, or truck receipt-3 copies; (c) Manufacturer’s or Supplier’s warranty certificate-3 copies; and (d) Certificate of origin-6 copies. <p>The Purchaser, shall receive the above documents before the arrival of the Goods at the place of destination and, if not received, the Supplier shall be responsible for any consequent expenses.</p>
GCC 25.1	The Contract price is: <i>[insert the contract Price]</i>

GCC 26.2	Responsibility of the Purchaser and Supplier is: As stated in GCC clause 26.1
GCC 27.1	The method and conditions of payment to be made to the Supplier under this Contract shall be as follows:
	<p>Payment for Goods supplied from abroad:</p> <p>(a) Payment shall be made through an irrevocable confirmed letter of credit opened in favour of the Supplier or authorized representatives of supplier's in a scheduled bank of Bangladesh.</p> <p>(b) Payment of local currency portion shall be made in Bangladesh Taka.</p> <p>(c) Payment of foreign currency portion shall be made in contracted currency.</p> <p>(d) Payment shall be made in the following manner.</p>
	<p><u>(i) For Dredger:</u></p> <p>1st Stage : 10 (ten) percent of the Contract Price of the goods shall be paid within 30 (thirty) days on presentation of supplier's invoice with relevant certificates/documents as per Clause GCC 32.1 towards approval of drawing, preparation & laying of keel of dredgers which shall be supported by inspection certificates issued by the Classification Society, and upon submission of claim along with a bank guarantee for equivalent amount. The bank guarantee shall be valid until the goods are delivered to the Final Destination and in the form provided in the Tender Document (PG4-10).</p> <p>2nd Stage : 20 (twenty) percent of the Contract Price of the goods shall be paid within 30 (thirty) days on presentation of supplier's invoice with relevant certificates/documents as per Clause GCC 32.1 towards completion of main hull of dredgers at the factory of manufacturer's yard (s) which shall be supported by inspection certificates issued by the representative (s) of Purchaser, Classification Society and Consultant, and upon submission of Bank Guarantee for an equivalent amount. The bank guarantee shall be valid until the goods are delivered to the Final Destination.</p> <p>3rd Stage : 35 (thirty five) percent of the Contract Price of the goods shall be paid within 30 (thirty) days on presentation of supplier's invoice with relevant certificates/documents as per Clause GCC 32.1 towards inspection of main engine, auxiliary engine, generator, dredge pump, hydraulic pump and cutter at the factory of manufacturer's yard (s) which shall be supported by inspection certificates issued by the Purchaser's representative (s), and upon submission of Bank Guarantee for an equivalent amount. The bank guarantee shall be valid until the goods are delivered to the Final Destination.</p> <p>4th Stage : 25 (twenty five) percent of the Contract Price of the goods shall be paid within 30 (thirty) days upon presentation of Supplier's invoice, Test & Trial Certificates of Dredger (separate certificate for each dredger) which shall be supported by inspection certificates issued by the representative (s) of Purchaser, Classification Society and Consultant and other documents as specified in PCC against the Clauses GCC 32.1 and upon submission of Bank Guarantee for an equivalent amount valid until the Goods are delivered to the Final Destination.</p> <p>5th Stage : 10 (ten) percent of the Contract Price of the goods shall be paid within 30 (thirty) days of issuance of Final Acceptance Certificate issued by the representative (s) of Purchaser, Classification Society & Consultant, upon presentation of Supplier's invoice and on submission of certificates/documents as per Clause GCC 23.2 of PCC.</p>

	<p>All the above Bank Guarantees shall be issued from a scheduled bank of Bangladesh or from any foreign bank duly endorsed by any schedule bank of Bangladesh. Charges for the establishment or amendment of letter of credit shall be borne by the Purchaser. However, if amendment is made at the specific request of the supplier, charges for such amendment of the letter of credit shall be borne by the supplier.</p>
	<p><u>(ii) For Crane Boats:</u></p> <p>1st Stage : 10 (ten) percent of the Contract Price of the goods shall be paid within 30 (thirty) days on presentation of supplier's invoice with relevant certificates/documents as per Clause GCC 32.1 towards approval of drawing, preparation & laying of keel of Crane Boats which shall be supported by inspection certificates issued by the Classification Society, and upon submission of claim along with a bank guarantee for equivalent amount. The bank guarantee shall be valid until the goods are delivered to the Final Destination and in the form provided in the Tender Document (PG4-10).</p> <p>2nd Stage : 20 (twenty) percent of the Contract Price of the goods shall be paid within 30 (thirty) days on presentation of supplier's invoice with relevant certificates/documents as per Clause GCC 32.1 towards completion of main hull of crane boats at the factory of manufacturer's yard (s) which shall be supported by inspection certificates issued by the representative (s) of Purchaser, Classification Society and Consultant, and upon submission of Bank Guarantee for an equivalent amount. The bank guarantee shall be valid until the goods are delivered to the Final Destination.</p> <p>3rd Stage : 20 (twenty) percent of the Contract Price of the goods shall be paid within 30 (thirty) days on presentation of supplier's invoice with relevant certificates/documents as per Clause GCC 32.1 towards inspection of engine, generator and crane of crane boats at the factory of manufacturer's yard (s) which shall be supported by inspection certificates issued by the Purchaser's representative (s), and upon submission of Bank Guarantee for an equivalent amount. The bank guarantee shall be valid until the goods are delivered to the Final Destination.</p> <p>4th Stage : 40 (forty) percent of the Contract Price of the goods shall be paid within 30 (thirty) days upon presentation of Supplier's invoice, Test & Trial Certificates of Crane Boats (separate certificate for each Crane Boat) which shall be supported by inspection certificates issued by the representative (s) of Purchaser, Classification Society and Consultant and other documents as specified in PCC against the Clauses GCC 32.1 and upon submission of Bank Guarantee for an equivalent amount valid until the Goods are delivered to the Final Destination.</p> <p>5th Stage : 10 (ten) percent of the Contract Price of the goods shall be paid within 30 (thirty) days of issuance of Final Acceptance Certificate issued by the representative (s) of Purchaser, Classification Society & Consultant, upon presentation of Supplier's invoice and on submission of certificates/documents as per Clause GCC 23.2 of PCC.</p>

	<p><u>iii) For HDPE Shore pipe, HDPE Floating pipe, Foam type Floater:</u></p> <p>1st Stage : 30 (Thirty) percent of the Contract Price of the concerned goods shall be paid within 30 (Thirty) days upon presentation of Supplier's invoice with relevant certificates/documents as per clause GCC clause 32.1 towards inspection of HDPE Shore pipe, HDPE Floating Pipe, and Foam type Floater at the factory of manufacturer yard (s) before shipment of goods which shall be supported by inspection certificates issued by the Purchaser's representative (s) and upon submission of Bank Guarantee for an equivalent amount valid until the Goods are delivered to the Final Destination.</p> <p>2nd Stage 70 (seventy) percent of the Contract Price of the goods shall be paid within 30 (thirty) days of issuance of Final Acceptance Certificate issued by the representative (s) of Purchaser and Consultant along with specification survey certificate issued by classification society, upon presentation of Supplier's invoice and on submission of certificates/documents as per Clause GCC 23.2 of PCC.</p>
	<p><u>(iv) For Ball Socket:</u></p> <p>1st Stage : 30 (Thirty) percent of the Contract Price of the concerned goods shall be paid within 30 (Thirty) days upon presentation of Supplier's invoice with relevant certificates/documents as per clause GCC clause 32.1 towards inspection of Ball Socket at the factory of manufacturer yard (s) before shipment of goods which shall be supported by inspection certificates issued by the Purchaser's representative (s) and upon submission of Bank Guarantee for an equivalent amount valid until the Goods are delivered to the Final Destination.</p> <p>2nd Stage 70 (seventy) percent of the Contract Price of the goods shall be paid within 30 (thirty) days of issuance of Final Acceptance Certificate issued by the representative (s) of Purchaser and Consultant along with specification survey certificate issued by classification society, upon presentation of Supplier's invoice and on submission of certificates/documents as per Clause GCC 23.2 of PCC.</p>
	<p><u>(v) For Rubber Hose Pipe:</u></p> <p>1st Stage : 30 (Thirty) percent of the Contract Price of the concerned goods shall be paid within 30 (Thirty) days upon presentation of Supplier's invoice with relevant certificates/documents as per clause GCC clause 32.1 towards inspection of Rubber Hose Pipe at the factory of manufacturer yard (s) before shipment of goods which shall be supported by inspection certificates issued by the Purchaser's representative (s) and upon submission of Bank Guarantee for an equivalent amount valid until the Goods are delivered to the Final Destination.</p> <p>2nd Stage 70 (seventy) percent of the Contract Price of the goods shall be paid within 30 (thirty) days of issuance of Final Acceptance Certificate issued by the representative (s) of Purchaser and Consultant along with specification survey certificate issued by classification society, upon presentation of Supplier's invoice and on submission of certificates/documents as per Clause GCC 23.2 of PCC</p>

	<p><u>(vi) For Spare Parts:</u></p> <p>1st Stage : 30 (Thirty) percent of the Contract Price of the concerned goods shall be paid within 30 (Thirty) days upon presentation of Supplier's invoice with relevant certificates/documents as per clause GCC clause 32.1 towards inspection of Spare Parts of main engine & auxiliary engine of dredger & crane boat at the factory of manufacturer yard (s) before shipment of goods which shall be supported by inspection certificates issued by the Purchaser's representative (s) and upon submission of Bank Guarantee for an equivalent amount valid until the Goods are delivered to the Final Destination.</p> <p>2nd Stage : 70 (seventy) percent of the Contract Price of the goods shall be paid within 30 (thirty) days of issuance of Final Acceptance Certificate issued by the Purchaser's representative and consultant (s) along with specification survey certificate issued by classification society, upon presentation of Supplier's invoice and on submission of certificates/documents as per Clause GCC 23.2 of PCC</p>
	<p><u>(vii) For F.S wire rope:</u></p> <p>100 (one hundred) percent of the Contract Price of the goods shall be paid within 30 (thirty) days of issuance of Final Acceptance Certificate issued by the Purchaser's representative(s) and consultant along with specification survey certificate issued by classification society, upon presentation of Supplier's invoice and on submission of certificates/documents as per Clause GCC 23.2 of PCC.</p> <p><u>viii) For classification Society:</u></p> <p>Payment of classification society shall be made at the following stages:</p> <p><u>viii-a) For Dredger:</u></p> <p>1st Stage : 10 (Ten) percent of the Contract Price of inspection (applicable for each Dredger) shall be paid towards submission of class approved keel laying plan which shall be supported by keel laying certificate issued by the classification society.</p> <p>2nd Stage : 20 (twenty) percent of the Contract Price of inspection (applicable for each Dredger) shall be paid upon submission of hull related approved basic drawings and completion of main hull which shall be supported by inspection certificates issued by the classification society.</p> <p>3rd Stage : 20 (twenty) percent of the Contract Price of inspection (applicable for each Dredger) shall be paid on placement of Engine and generator at manufacturer's premises which shall be supported by class certificates issued by the classification society.</p> <p>4th Stage : 20 (Twenty) percent of the Contract Price of inspection (applicable for each Dredger) shall be paid upon submission of superstructure, piping, electrical & outfitting related approved basic drawings and installation of Engine, dredge pump & other equipment on Board which shall be supported by inspection certificates issued by the classification society.</p> <p>5th Stage : 20 (Twenty) percent of the Contract Price of inspection (applicable for each Dredger) shall be paid of successful completion of Test trail which shall be supported by inspection certificates issued by the classification society</p> <p>6th Stage : 10 (Ten) percent of the Contract Price of inspection (applicable for each Dredger) shall be paid upon issuance of as built all approved drawings, completion of specification survey, Final Acceptance Certificate and final class certificate issued by the classification society.</p>

	<p><u>viii-b) For Crane Boat:</u></p> <p>1st Stage : 10 (Ten) percent of the Contract Price of inspection (applicable for each Crane boat) shall be paid towards submission of class approved keel laying plan which shall be supported by keel laying certificate issued by the classification society.</p> <p>2nd Stage : 20 (twenty) percent of the Contract Price of inspection (applicable for each Crane Boat) shall be paid upon submission of hull related approved basic drawings and completion of main hull which shall be supported by inspection certificates issued by the classification society.</p> <p>3rd Stage : 20 (twenty) percent of the Contract Price of inspection (applicable for each Crane Boat) shall be paid on placement of Engine and generator at manufacturer's premises which shall be supported by class certificates issued by the classification society.</p> <p>4th Stage : 20 (Twenty) percent of the Contract Price of inspection (applicable for each Crane Boat) shall be paid upon submission of superstructure, piping, electrical & outfitting related approved basic drawings and installation of Engine, dredge pump & other equipment on Board which shall be supported by inspection certificates issued by the classification society.</p> <p>5th Stage : 20 (twenty) percent of the Contract Price of inspection (applicable for each Crane Boat) shall be paid of successful completion of Test trail which shall be supported by inspection certificates issued by the classification society</p> <p>6th Stage : 10 (Ten) percent of the Contract Price of inspection (applicable for each Crane Boat) shall be paid upon issuance of as built all approved drawings, completion of specification survey, Final Acceptance Certificate and final class certificate issued by the classification society.</p> <p><u>viii-c) For HDPE Shore pipe, HDPE Floating Pipe, Foam type Floater, Ball Socket, Spare parts, Rubber Hose Pipe & F.S Wire Rope (Different sizes):</u></p> <p>100 (One Hundred) percent of the Contract Price of concerned Goods (Applicable for Each item) shall be paid upon completion of specification survey and issuance of specification survey certificate issued by the classification society.</p> <p>All the above Bank Guarantees shall be issued from a scheduled bank of Bangladesh or from any foreign bank duly endorsed by any schedule bank of Bangladesh.</p> <p>Charges for the establishment or amendment of letter of credit shall be borne by the Purchaser. However, if amendment is made at the specific request of the supplier, charges for such amendment of the letter of credit shall be borne by the supplier.</p>
	<p><u>Payment for Goods manufactured in Bangladesh:</u></p> <p>(a) Payment shall be made through an irrevocable confirmed letter of credit opened in favour of the Supplier or authorized representatives of supplier's in a scheduled bank of Bangladesh.</p> <p>(b) Payment of local currency portion shall be made in Bangladesh Taka.</p> <p>(c) Payment of foreign currency portion shall be made in contracted currency.</p> <p>(d) Payment shall be made in the following manner:</p>

(i) Payment of the goods (28" dredgers) shall be made at the following stages:

- 1st Stage** : 10 (ten) percent of the Contract Price of the goods (applicable for each dredger) shall be paid within 30 (thirty) days on presentation of supplier's invoice with relevant certificates/documents as per Clause GCC clause 32.1 towards approval of drawing, preparation & laying of keel of 28" dredgers which shall be supported by inspection certificates issued by the representative (s) of Purchaser, Classification society, as well as Consultant and upon submission of claim along with a bank guarantee for equivalent amount. The bank guarantee shall be valid until the goods are delivered to the Final Destination and in the form provided in the Tender Document **(PG4-10)**.
- 2nd Stage** : 20 (Twenty) percent of the Contract Price of the goods (applicable for each dredger) shall be paid within 30 (Thirty) days on presentation of supplier's invoice with relevant certificates/documents as per Clause GCC clause 32.1 on completion of main hull of 28" dredgers at the factory of manufacturer's yard (s) which shall be supported by inspection certificates issued by the representative (s) of Purchaser, Classification society, as well as Consultant, and upon submission of Bank Guarantee for an equivalent amount. The bank guarantee shall be valid until the goods are delivered to the Final Destination.
- 3rd Stage** : 20 (twenty) percent of the Contract Price of the goods (applicable for each dredger) shall be paid within 30 (Thirty) days on presentation of supplier's invoice with relevant certificates/documents as per Clause GCC clause 32.1 towards inspection of main engine, auxiliary engine, generator of dredgers at the factory of manufacturer's yard (s) before shipment of goods which shall be supported by inspection certificates issued by the Purchaser's representative (s), and upon submission of Bank Guarantee for an equivalent amount. The bank guarantee shall be valid until the goods are delivered to the Final Destination.
- 4th Stage** : 20 (twenty) percent of the Contract Price of the goods (applicable for each dredger) shall be paid within 30 (thirty) days on presentation of supplier's invoice with relevant certificates/documents as per Clause GCC clause 32.1 towards inspection of dredge pump, hydraulic pump and cutter of dredgers at the factory of manufacturer's yard (s) before shipment of goods and placement of main engine, auxiliary engine on board the dredger which shall be supported by inspection certificates issued by the Purchaser's representative (s), and upon submission of Bank Guarantee for an equivalent amount. The bank guarantee shall be valid until the goods are delivered to the Final Destination.
- 5th Stage** : 20 (twenty) percent of the Contract Price of the goods (applicable for each dredger) shall be paid within 30 (thirty) days upon presentation of supplier's invoice towards completion of installation of engines and other accessories and test-trial certificates of dredgers which shall be supported by inspection certificates issued by the representative (s) of Purchaser, Classification society as well as Consultant and other documents as specified in PCC against the Clauses GCC 32.1 and upon submission of Bank Guarantee for an equivalent amount valid until the Goods are delivered to the Final Destination.

	<p>6th Stage : 10 (ten) percent of the Contract Price of the goods (applicable for each dredger) shall be paid within 30 (thirty) days of issuance of Final Acceptance Certificate issued by the representative (s) of Purchaser, Classification society as well as Consultant, upon presentation of Supplier's invoice and on submission of certificates/documents as per Clause GCC 23.2 of PCC.</p>
	<p><u>(ii) Payment of the goods (crane boats) shall be made at the following stages:</u></p> <p>1st Stage : 10 (ten) percent of the Contract Price of the goods (applicable for each crane boat) shall be paid within 30 (thirty) days on presentation of supplier's invoice with relevant certificates/documents as per Clause GCC 32.1 towards approval of drawing, preparation & laying of keel of crane boats which shall be supported by inspection certificates issued by the representative (s) of Purchaser, Classification society as well as Consultant and upon submission of claim along with a bank guarantee for equivalent amount. The bank guarantee shall be valid until the goods are delivered to the Final Destination and in the form provided in the Tender Document (PG4-10).</p> <p>2nd Stage : 20 (twenty) percent of the Contract Price of the goods (applicable for each crane boat) shall be paid within 30 (thirty) days on presentation of supplier's invoice with relevant certificates/documents as per Clause GCC 32.1 on completion of main hull of crane boats at the factory of manufacturer's yard (s) which shall be supported by inspection certificates issued by the representative (s) of Purchaser, Classification society as well as Consultant and upon submission of Bank Guarantee for an equivalent amount. The bank guarantee shall be valid until the goods are delivered to the Final Destination.</p> <p>3rd Stage : 25 (twenty five) percent of the Contract Price of the goods (applicable for each crane boat) shall be paid within 30 (thirty) days on presentation of supplier's invoice with relevant certificates/documents as per Clause GCC 32.1 towards inspection of main engine, auxiliary engine, generator & crane of crane boats at the factory of manufacturer yard (s) before shipment which shall be supported by inspection certificates issued by the Purchaser's representative (s), and upon submission of Bank Guarantee for an equivalent amount. The bank guarantee shall be valid until the goods are delivered to the Final Destination.</p> <p>4th Stage : 35 (thirty five) percent of the Contract Price of the goods (applicable for each crane boat) shall be paid within 30 (thirty) days upon presentation of Supplier's invoice towards completion of installation of engines and other accessories and test-trial certificates of crane boats which shall be supported by inspection certificates issued by the representative (s) of Purchaser, Classification society as well as Consultant and other documents as specified in PCC against the Clauses GCC 32.1 and upon submission of Bank Guarantee for an equivalent amount valid until the Goods are delivered to the Final Destination.</p> <p>5th Stage : 10 (ten) percent of the Contract Price of the goods (applicable for each crane boat) shall be paid within 30 (thirty) days of issuance of Final Acceptance Certificate issued by the representative (s) of Purchaser, Classification society as well as Consultant, upon presentation of Supplier's invoice and on submission of certificates/documents as per Clause GCC 23.2.</p>
	<p><u>(iii) Payment of the goods (HDPE Shore pipe, HDPE Floating Pipe, Foam type Floater) shall be made at the following stages:</u></p> <p>1st Stage : 30 (Thirty) percent of the Contract Price of the goods (applicable for each item) shall be paid within 30 (thirty) days upon presentation of Supplier's invoice with relevant certificates/documents as per clause GCC 32.1 towards inspection of HDPE Shore pipe, HDPE Floating</p>

	<p>Pipe, and Foam type Floater at the factory of manufacturer yard (s) before shipment of goods which shall be supported by inspection certificates issued by the Purchaser's representative (s) and upon submission of claim along with a bank guarantee for equivalent amount. The bank guarantee shall be valid until the goods are delivered to the Final Destination and in the form provided in the Tender Document (PG4-10).</p> <p>2nd Stage 70 (Seventy) percent of the Contract Price of the goods shall be paid within 30 (thirty) days of issuance of Final Acceptance Certificate issued by the representative (s) of Purchaser as well as Consultant along with specification survey certificate issued by classification society, upon presentation of Supplier's invoice and on submission of certificates/documents as per Clause GCC 23.2</p>
	<p><u>(iv) Payment of the goods (Ball Socket) shall be made at the following stages:</u></p> <p>1st Stage : 30 (Thirty) percent of the Contract Price of the concerned goods shall be paid within 30 (thirty) days upon presentation of Supplier's invoice with relevant certificates/documents as per clause GCC 32.1 towards inspection of Ball Socket at the factory of manufacturer yard (s) before shipment of goods and upon submission of claim along with a bank guarantee for equivalent amount. The bank guarantee shall be valid until the goods are delivered to the Final Destination and in the form provided in the Tender Document (PG4-10).</p> <p>2nd Stage 70 (Seventy) percent of the Contract Price of the goods shall be paid within 30 (thirty) days of issuance of Final Acceptance Certificate issued by the representative (s) of Purchaser as well as Consultant along with specification survey certificate issued by classification society, upon presentation of Supplier's invoice and on submission of certificates/documents as per Clause GCC 23.2</p>
	<p><u>(v) Payment of the goods (Rubber Hose Pipe) shall be made at the following stages:</u></p> <p>1st Stage : 30 (Thirty) percent of the Contract Price of the concerned goods shall be paid within 30 (thirty) days upon presentation of Supplier's invoice with relevant certificates/documents as per clause GCC 32.1 towards inspection of Rubber Hose Pipe at the factory of manufacturer yard (s) before shipment of goods and upon submission of claim along with a bank guarantee for equivalent amount. The bank guarantee shall be valid until the goods are delivered to the Final Destination and in the form provided in the Tender Document (PG4-10).</p> <p>2nd Stage 70 (Seventy) percent of the Contract Price of the goods shall be paid within 30 (thirty) days of issuance of Final Acceptance Certificate issued by the representative (s) of Purchaser as well as Consultant along with specification survey certificate issued by classification society, upon presentation of Supplier's invoice and on submission of certificates/documents as per Clause GCC 23.2.</p>
	<p><u>(vi) Payment of the goods (Spare Parts) shall be made at the following stages:</u></p> <p>1st Stage : 30 (Thirty) percent of the Contract Price of the goods shall be paid within 30 (thirty) days upon presentation of Supplier's invoice with relevant certificates/documents as per clause GCC 32.1 towards inspection of spare parts of main engine & auxiliary engine of dredgers & crane boats at the factory of manufacturer yard (s) before shipment of goods which shall be supported by inspection certificates issued by</p>

	<p>the Purchaser's representative (s) and upon submission of claim along with a bank guarantee for equivalent amount. The bank guarantee shall be valid until the goods are delivered to the Final Destination and in the form provided in the Tender Document (PG4-10).</p> <p>2nd Stage : 70 (Seventy) percent of the Contract Price of the goods shall be paid within 30 (thirty) of issuance of Final Acceptance Certificate issued by the Purchaser's representative (s) and consultant along with specification survey certificate issued by classification society, upon presentation of Supplier's invoice and on submission of certificates/documents as per Clause GCC 23.2 of PCC.</p>
	<p><u>(vii) For F.S wire rope:</u></p> <p>100 (one hundred) percent of the Contract Price of the goods shall be paid within 30 (thirty) days of issuance of Final Acceptance Certificate issued by the Purchaser's representative(s) and consultant along with specification survey certificate issued by classification society, upon presentation of Supplier's invoice and on submission of certificates/documents as per Clause GCC 23.2 of PCC.</p> <p><u>viii) For classification Society:</u></p> <p>Payment of classification society shall be made at the following stages:</p> <p><u>viii-a) For Dredger:</u></p> <p>1st Stage : 10 (Ten) percent of the Contract Price of inspection (applicable for each Dredger) shall be paid towards submission of class approved keel laying plan which shall be supported by keel laying certificate issued by the classification society.</p> <p>2nd Stage : 20 (twenty) percent of the Contract Price of inspection (applicable for each Dredger) shall be paid upon submission of hull related approved basic drawings and completion of main hull which shall be supported by inspection certificates issued by the classification society.</p> <p>3rd Stage : 20 (twenty) percent of the Contract Price of inspection (applicable for each Dredger) shall be paid on placement of Engine and generator at manufacturer's premises which shall be supported by class certificates issued by the classification society.</p> <p>4th Stage : 20 (Twenty) percent of the Contract Price of inspection (applicable for each Dredger) shall be paid upon submission of superstructure, piping, electrical & outfitting related approved basic drawings and installation of Engine, dredge pump & other equipment on Board which shall be supported by inspection certificates issued by the classification society.</p> <p>5th Stage : 20 (Twenty) percent of the Contract Price of inspection (applicable for each Dredger) shall be paid of successful completion of Test trail which shall be supported by inspection certificates issued by the classification society</p> <p>6th Stage : 10 (Ten) percent of the Contract Price of inspection (applicable for each Dredger) shall be paid upon issuance of as built all approved drawings, completion of specification survey, Final Acceptance Certificate and final class certificate issued by the classification society.</p> <p><u>viii-b) For Crane Boat:</u></p> <p>1st Stage : 10 (Ten) percent of the Contract Price of inspection (applicable for each Crane boat) shall be paid towards submission of class approved keel laying plan which shall be supported by keel laying certificate issued by the classification society.</p>

	<p>2nd Stage : 20 (twenty) percent of the Contract Price of inspection (applicable for each Crane Boat) shall be paid upon submission of hull related approved basic drawings and completion of main hull which shall be supported by inspection certificates issued by the classification society.</p> <p>3rd Stage : 20 (twenty) percent of the Contract Price of inspection (applicable for each Crane Boat) shall be paid on placement of Engine and generator at manufacturer's premises which shall be supported by class certificates issued by the classification society.</p> <p>4th Stage : 20 (Twenty) percent of the Contract Price of inspection (applicable for each Crane Boat) shall be paid upon submission of superstructure, piping, electrical & outfitting related approved basic drawings and installation of Engine, dredge pump & other equipment on Board which shall be supported by inspection certificates issued by the classification society.</p> <p>5th Stage : 20 (twenty) percent of the Contract Price of inspection (applicable for each Crane Boat) shall be paid of successful completion of Test trail which shall be supported by inspection certificates issued by the classification society</p> <p>6th Stage : 10 (Ten) percent of the Contract Price of inspection (applicable for each Crane Boat) shall be paid upon issuance of as built all approved drawings, completion of specification survey, Final Acceptance Certificate and final class certificate issued by the classification society..</p> <p><u>viii-c) For HDPE Shore pipe, HDPE Floating Pipe, Foam type Floater, Ball Socket, Spare parts, Rubber Hose Pipe & F.S Wire Rope (Different sizes):</u></p> <p>100 (One Hundred) percent of the Contract Price of concerned Goods (applicable for each item) shall be paid upon completion of specification survey and issuance of specification survey certificate issued by the classification society.</p> <p>All the above Bank Guarantees shall be issued from a scheduled bank of Bangladesh or from any foreign bank duly endorsed by any schedule bank of Bangladesh.</p> <p>Charges for the establishment or amendment of letter of credit shall be borne by the Purchaser. However, if amendment is made at the specific request of the supplier, charges for such amendment of the letter of credit shall be borne by the supplier.</p>
GCC 27.3	Payments shall be made in no case later than the 45 (forty five) days after submission of an invoice or request for payment by the Supplier, and after the Purchaser has accepted it.
GCC 27.5	<p>The payment-delay period after which the Purchaser shall pay interest to the supplier shall be [-----] days after submission of an invoice or request for payment by the Supplier, and after the Purchaser has accepted it.</p> <p>The interest rate that shall be applied is 0% percent.</p> <p>Not Applicable</p>

GCC 28.2	The insurance coverage shall be: The insurance shall be in an amount equal to 110% percent of the CIP value of the goods from “Warehouse” to “Warehouse” on “All Risks” basis, including war risk and strikes.
GCC 32.1	<p>The inspections and tests shall be:</p> <p><u>For Goods manufactured in abroad</u></p> <p>a) For the dredgers complete:</p> <p>In addition to the inspections by the Class, the dredger, engines, equipment, machinery etc. shall be inspected by a team consisting of 5 (five) persons having at least 3 (three) technical persons of the Purchaser and/or its representative (s) to the manufacturer’s yard (s) or supplier’s premises at the following stages:</p> <p>1st Stage Inspection : On completion of hull of dredgers at the manufacturer’s yard (s). Consultant also inspects the work in this stage.</p> <p>2nd Stage Inspection : Inspection of main engine, auxiliary engine, generator, dredge pump, hydraulic pump and cutter of dredgers at the factory of manufacturer’s yard (s)..</p> <p>3rd stage inspection : Conduction of test & trials of all machinery and test of performance of dredger including dredging work at the factory of manufacturer’s yard (s). All cost for test & trial shall be borne by the supplier. Consultant also inspects the work in this stage.</p> <p>The total period of inspection at each stage shall be minimum 7 (seven) days excluding traveling & transit time. All incidental expenses for these inspections & training including travel, food, boarding etc. shall be borne by the Supplier.</p>

	<p>b) For the Crane Boats complete:</p> <p>In addition to the inspections by the Class, the crane boat, engines, generator & crane shall be inspected by a team consisting of 5 (five) persons having at least 3 (three) technical persons of the Purchaser and/or its representative (s) to the manufacturer yard (s) at the following stages:</p> <p>1st Stage Inspection : On completion of hull of crane boats at the manufacturer's yard (s). Consultant also inspects the work in this stage.</p> <p>2nd Stage Inspection : On inspection of main engine, auxiliary engine, generator and crane of crane boats at the factory of manufacturer's yard (s).</p> <p>3rd stage inspection : Conduction of test & trials of crane boats at the factory of manufacturer yard (s). Consultant also inspects the work in this stage.</p> <p>The total period of inspection at each stage shall be minimum 7 (seven) days excluding traveling & transit time. All incidental expenses for these inspections & training including travel, fooding, boarding, etc. shall be borne by the Supplier.</p>
	<p>c) For the HDPE Shore pipes, HDPE Floating pipes, Foam type floaters:</p> <p>Pre-Shipment Inspection (PSI)/Factory Acceptance Test (FAT) along with laboratory test for virgin raw material of HDPE Pipe and floater is mandatory to ensure the quality of material as desired by the procuring Entity and will be conducted by 4 (four) personnel having at least 3 (three) technical personnel to be nominated by Purchaser for a period at least 5 (five) days excluding the travel period at the cost of supplier at the manufacturer's yard of relevant goods before shipment. All expenses for these inspections including travel, food, boarding, etc. shall be borne by the supplier following latest government order regarding foreign travel allowances.</p> <p>d) For Ball sockets:</p> <p>Pre-shipment Inspection (PSI) / Factory Acceptance Test (FAT) is mandatory as desired by the procuring Entity and will be conducted by 4 (four) personnel having at least 3 (three) technical personnel to be nominated by Purchaser for a period at least 5 (five) days excluding the travel period at the cost of supplier at the manufacturer's yard of Ball Socket before shipment of goods. All expenses for these inspections including travel, food, barding, etc. shall be borne by the supplier following latest government order regarding foreign travel allowances.</p> <p>e) Rubber hose pipes:</p> <p>Pre-shipment Inspection (PSI) / Factory Acceptance Test (FAT) is mandatory as desired by the procuring Entity and will be conducted by 4 (four) personnel having at least 3 (three) technical personnel to be nominated by Purchaser for a period at least 5 (five) days excluding the travel period at the cost of supplier at the manufacturer's yard of Rubber Hose Pipe before shipment of goods. All expenses for these inspections including travel, food, boarding, etc. shall be borne by the supplier following latest government order regarding foreign travel allowances.</p> <p>f) Spare parts of main engine & auxiliary engine of dredgers & crane boat:</p> <p>Pre-shipment Inspection (PSI) is mandatory and will be conducted by 4 (four) personnel having at least 3 (three) technical personnel to be nominated by Purchaser for a period</p>

	<p>at least 5 (five) days excluding the travel period at the cost of supplier at the engine manufacturer's yard of Spare Parts before shipment. All expenses for these inspections including travel, fooding, boarding, etc. shall be borne by the supplier following latest government order regarding foreign travel allowances.</p> <p><i>The Purchaser's right to inspect, test and where appropriate reject the goods after delivery, shall in no way be limited or waived by the reason of goods having previously been inspected, tested or passed by the Purchaser or its representative prior the goods shipment.</i></p>
	<p><u>For Goods manufactured in Bangladesh</u></p> <p><u>a) Foreign Inspection</u></p> <p><u>(i) For engine of 28" dredgers</u></p> <p>In addition to the inspections by the Class, Pre-shipment Inspection (PSI) / Factory Acceptance Test (FAT) is mandatory as desired by the procuring Entity and will be conducted by 5 (five) personnel having at least 3 (three) technical personnel to be nominated by Purchaser for a period at least 7 (seven) days excluding the travel period at the cost of supplier at the manufacturer's yard (s) of main engine, auxiliary engine, generator of 28" dredgers before shipment. All expenses for these inspections including travel, food, boarding etc. shall be borne by the supplier following latest government order regarding foreign travel allowances.</p> <p>The Purchaser's right to inspect, test and where appropriate reject the goods after delivery, shall in no way be limited or waived by the reason of goods having previously been inspected, tested or passed by the Purchaser or its representative prior the goods shipment.</p> <p><u>(ii) For dredge pump, hydraulic pump and cutter of dredgers</u></p> <p>In addition to the inspections by the Class, Pre-shipment Inspection (PSI)/ Factory Acceptance Test (FAT) is mandatory as desired by the procuring Entity and will be conducted by 5 (five) personnel having at least 3 (three) technical personnel to be nominated by Purchaser for a period at least 7 (seven) days excluding the travel period at the cost of supplier at the manufacturer's yard (s) of dredge pump, hydraulic pump and cutter with concerned spare parts before shipment. All expenses for these inspections including travel, food, boarding, etc. shall be borne by the supplier following latest government order regarding foreign travel allowances.</p> <p>The Purchaser's right to inspect, test and where appropriate reject the goods after delivery, shall in no way be limited or waived by the reason of goods having previously been inspected, tested or passed by the Purchaser or its representative prior the goods shipment.</p> <p><u>(iii) For engine, generator & crane of crane boats</u></p> <p>In addition to the inspections by the Class, Pre-shipment Inspection (PSI)/Factory Acceptance Test (FAT) is mandatory as desired by the procuring Entity and will be conducted by 5 (five) personnel having at least 3 (three) technical personnel to be nominated by Purchaser for a period at least 7 (seven) days excluding the travel period at the cost of supplier at the manufacturer's yard (s) of engine, generator & crane of crane boats before shipment. All expenses for these inspections including travel, food, boarding, etc. shall be borne by the supplier following latest government order regarding foreign travel allowances.</p> <p>The Purchaser's right to inspect, test and where appropriate reject the goods after delivery, shall in no way be limited or waived by the reason of goods having previously</p>

	<p>been inspected, tested or passed by the Purchaser or its representative prior the goods shipment.</p>
	<p><u>(iv) For HDPE Shore Pipes, HDPE Floating Pipe, Foam Type Floater:</u></p> <p><i>In case of supply of above-mentioned goods from outside Bangladesh the condition shall be as follows:</i></p> <p>Pre-Shipment Inspection (PSI)/Factory Acceptance Test (FAT) along with laboratory test for virgin raw material of HDPE Pipe and floater is mandatory to ensure the quality of material as desired by the procuring Entity and will be conducted by 4 (four) personnel having at least 3 (three) technical personnel to be nominated by Purchaser for a period at least 5 (five) days excluding the travel period at the cost of supplier at the manufacturer’s yard of relevant goods before shipment. All expenses for these inspections including travel, food, boarding, etc. shall be borne by the supplier following latest government order regarding foreign travel allowances.</p> <p><i>In case of supply of above-mentioned goods from within Bangladesh the condition shall be as follows:</i></p> <p>Pre-Shipment Inspection (PSI) of Virgin raw material and laboratory test is mandatory to ensure the quality of material of HDPE pipes & Floater as desired by the procuring Entity and will be conducted by 4 (four) personnel having at least 3 (three) technical personnel to be nominated by Purchaser for a period at least 5 (five) days excluding the travel time at the manufacturer’s factory of Virgin raw Material before shipment. Inspection at Port of Landing of raw material is also mandatory which shall be done by the purchaser. All expenses for these inspections including travel, food, boarding, etc. shall be borne by the supplier following latest government order regarding foreign travel allowances.</p> <p><i>The Purchaser’s right to inspect, test and where appropriate reject the goods after delivery, shall in no way be limited or waived by the reason of goods having previously been inspected, tested or passed by the Purchaser or its representative prior the goods shipment.</i></p>
	<p><u>(v) For Ball Socket:</u></p> <p>Pre-shipment Inspection (PSI) / Factory Acceptance Test (FAT) is mandatory as desired by the procuring Entity and will be conducted by 4 (four) personnel having at least 2 (two) technical personnel to be nominated by Purchaser for a period at least 5 (five) days excluding the travel period at the cost of supplier at the manufacturer’s yard of Ball Socket before shipment of goods. All expenses for these inspections including travel, food, boarding, etc. shall be borne by the supplier following latest government order regarding foreign travel allowances.</p> <p>The Purchaser’s right to inspect, test and where appropriate reject the goods after delivery, shall in no way be limited or waived by the reason of goods having previously been inspected, tested or passed by the Purchaser or its representative prior the goods shipment.</p>

	<p><u>(vi) For Rubber Hose Pipe:</u></p> <p>Pre-shipment Inspection (PSI) / Factory Acceptance Test (FAT) is mandatory as desired by the procuring Entity and will be conducted by 4 (four) personnel having at least 2 (two) technical personnel to be nominated by Purchaser for a period at least 5 (five) days excluding the travel period at the cost of supplier at the manufacturer's yard of Rubber Hose Pipe before shipment of goods. All expenses for these inspections including travel, food, boarding, etc. shall be borne by the supplier following latest government order regarding foreign travel allowances.</p> <p>The Purchaser's right to inspect, test and where appropriate reject the goods after delivery, shall in no way be limited or waived by the reason of goods having previously been inspected, tested or passed by the Purchaser or its representative prior the goods shipment.</p>
	<p><u>(vii) For Spare Parts of main engine & auxiliary engine of dredgers & crane boats:</u></p> <p>Pre-shipment Inspection (PSI) is mandatory and will be conducted by 4 (four) personnel having at least 3 (three) technical personnel to be nominated by Purchaser for a period at least 5 (five) days excluding the travel period at the cost of supplier at the engine manufacturer's yard of above spare parts before shipment. All expenses for these inspections including travel, food, boarding, etc. shall be borne by the supplier following latest government order regarding foreign travel allowances.</p> <p>The Purchaser's right to inspect, test and where appropriate reject the goods after delivery, shall in no way be limited or waived by the reason of goods having previously been inspected, tested or passed by the Purchaser or its representative prior the goods shipment.</p>
	<p><u>b) Local Inspection and conducting Test-Trials:</u></p> <p><u>(i) For dredgers (28")</u></p> <p>During manufacturing of dredgers, in addition to the inspections by the Classification Society and Consultant, the dredgers shall be inspected by a team consisting of 5 officials of the Purchaser and/or its representative(s) to the supplier's premises in the following stages:</p> <p>1st Stage Inspection : Preparation & laying of keel.</p> <p>2nd Stage Inspection : On completion of main hull (before cleaning & painting) of the dredgers.</p> <p>3rd Stage Inspection : Placement of main engine & auxiliary engine on board the dredger.</p> <p>4th Stage Inspection : Conduction of test & trials of all machinery and test of dredging works performance of dredger in the Suppliers' premises. All cost for test & trial shall be borne by the supplier.</p> <p>Other than the above four local inspections, the representative (s) of the purchaser may inspect the construction work at any time.</p> <p>Moreover, the purchaser shall depute technical personnel to supervise the construction work during the whole construction period. Lodging and fooding for technical personnel have to be provided by the supplier.</p>

	<p><i>N.B: This inspection shall be applicable for all the vessels separately</i></p> <p><u>ii) For crane boats:</u></p> <p>During manufacturing of crane boats, in addition to the inspections by the Classification Society and Consultant, the above vessels shall be inspected (each separately) by a team consisting of 5 officials of the Purchaser and/or its representative(s) to the supplier's premises in the following stages:</p> <p>1st Stage Inspection : Preparation & laying of keel.</p> <p>2nd Stage Inspection : On completion of main hull (before cleaning & painting) of the vessels.</p> <p>3rd Stage Inspection : Installation of main engine, auxiliary engine, propeller shaft, propeller, rudder shaft, rudder, steering system, hydraulic system etc. for vessels.</p> <p>4th Stage Inspection : Conduction of test & trials of vessels in the Suppliers' premises. All cost for test & trial shall be borne by the supplier.</p> <p>Other than the above four local inspections, the representative (s) of the purchaser may inspect the construction work at any time.</p> <p>Moreover, the purchaser shall depute technical personnel to supervise the construction work during the whole construction period. Lodging and fooding for technical personnel have to be provided by the supplier.</p> <p><i>N.B: This inspection shall be applicable for all the vessels separately</i></p>
	<p><u>iii) For HDPE Shore Pipe, HDPE Floating Pipe, Foam type Floater:</u></p> <p>After 100% delivery of the above goods shall be inspected by a team consisting of 5 officials of the Purchaser and/or its representative(s) to the purchaser's premises/Store.</p>
	<p><u>iv) Ball Socket:</u></p> <p>After 100% delivery of the above goods shall be inspected by a team consisting of 5 officials of the Purchaser and/or its representative(s) to the purchaser's premises/Store.</p>
	<p><u>v) Rubber Hose Pipe:</u></p> <p>After 100% delivery of the above goods shall be inspected by a team consisting of 5 officials of the Purchaser and/or its representative(s) to the purchaser's premises/Store.</p>
	<p><u>vi) For Spare Parts:</u></p> <p>After 100% delivery of the above spare parts shall be inspected by a team consisting of 5 officials of the Purchaser and/or its representative(s) to the purchaser's premises/Store.</p>
	<p><u>vii) For F.S wire rope:</u></p> <p>After 100% delivery of the above items shall be inspected by a team consisting of 5 Officials of the Purchaser and/or its representative(s) to the purchaser's premises/Store.</p>
<p>GCC 33.3</p>	<p>(i) The period of validity of the Warranty shall be 365 (three hundred sixty-five) days from date of acceptance of the Goods.</p> <p>(ii) The period of validity of repair and or replacement warranty for HDPE Shore pipe and floating pipe and Foam type floater shall be 02 (Two) years from the date of final acceptance of HDPE Shore pipe and floating pipe, and Foam type floater. For purpose of the Warranty, the place(s) of final destination(s) shall be: Dredger Base, BIWTA, Narayanganj, Bangladesh.</p>

GCC 33.6	The Supplier shall correct any defects covered by the Warranty within 28 (twenty-eight) days of being notified by the Purchaser of the occurrence of such defects.
GCC 35.1	<p>a) With respect to delay in delivery:</p> <p>The applicable rate for liquidated damages for delay shall be 0.50% (one half of one) of the contract price of the delayed Goods for each week or part thereof of delay until actual delivery.</p> <p><u>b) With respect to technical aspect:</u></p> <p><u>i) Dredger-28":</u></p> <p>Draft: In case the dredger draft is in excess of 2.00 m in fully loaded condition, the supplier shall pay liquidated damages to the purchaser at 0.5% for 0.75 cm upto a maximum limit of 10% of contract price of dredger.</p> <p>Dredging depth: In case the Dredging depth is less than 20.00 m at 50° ladder angle at minimum 2200 cubic meter/hour of solid output at discharge distance of 2500 m, the supplier shall pay liquidated damages to the purchaser at 1 % for 10 centimeter up to a maximum limit of 10% of contract price of 28 inch cutter suction dredger.</p> <p>Production capacity: In the case of Production capacity is less than 2200 cubic meter/hour of solid output at discharge distance of 2500 m at 20.00 m dredging depth at 50° ladder angle, the supplier shall pay liquidated damages to the purchaser at 1 % for 20 cubic meter/hour up to a maximum limit of 10% of contract price of 28 inch cutter suction dredger.</p> <p>Discharge distance: In case of discharge distance is less than 2500 meter at minimum 2200 cubic meter/hour of solid output at 20.00 m dredging depth at 50° ladder angle, the supplier shall pay liquidated damages to the purchaser at 1 % for 30 meter up to a maximum limit of 10% of contract price of 28 inch cutter suction dredger.</p> <p><u>ii) Crane Boat for 28" Dredgers:</u></p> <p>Draft: In case the Crane Boat draft is in excess of 1.20 m in fully loaded condition, the supplier shall pay liquidated damages to the purchaser at 0.5% for 0.75 centimeter upto a maximum limit of 10% of contract price of Crane Boat.</p> <p>Speed: In case of failure to achieve the Crane Boats speed of 7.50 knots at maximum continuous power rating (MCR) in fully loaded condition at 1.20 m draft, the supplier shall pay liquidated damages to the purchaser at 1% for 0.05 knot reduction upto a maximum limit of 10% of contract price of Crane Boat.</p>
GCC 47.2(b)	The Adjudicator Jointly Appointed by the parties during contract signing.
GCC 47.3(b)	<p>The rules of procedure for arbitration proceedings shall be as follows:</p> <p>(i) Contract with foreign Supplier:</p> <p>Any dispute, controversy or claim arising out of or relating to this Contract, or breach, termination or invalidity thereof, shall be settled by arbitration in accordance with the UNCITRAL Arbitration Rules as at present in force.</p> <p style="text-align: center;">OR</p> <p>All disputes arising in connection with the present Contract shall be finally settled under the Rules of Conciliation and Arbitration of the International</p>

	<p>Chamber of Commerce by one or more arbitrators appointed in accordance with said Rules.</p> <p>(b) <i>Contracts with Supplier national of the Purchaser's country:</i></p> <p>In the case of a dispute between the Purchaser and a Supplier who is a national of the Bangladesh, the dispute shall be referred to adjudication or arbitration in accordance with the laws of the Bangladesh i.e. Arbitration Act (Act No 1 of 2001) of Bangladesh as at present in force.</p>
--	--

Section 5. Tender and Contract Forms

Form	Title
Tender Forms	
PG4 – 1	Tender Submission Letter
PG4 – 2	Tenderer Information Sheet
PG4-2A	Subcontractor Information
PG4 – 3A,3B & 3C	Price Schedule for Goods
PG4 – 3D	Price Schedule for Related Services
PG4 – 4	Specifications Submission and Compliance Sheet
PG4 – 5	Manufacturer’s Authorisation Letter
PG4 – 6	Bank Guarantee for Tender Security
PG4 – 6A	Bank’s Commitment for Line of Credit <i>(when this option is chosen)</i>
Contract Forms	
PG4 – 7	Notification of Award
PG4 – 8	Contract Agreement
PG4 – 9	Bank Guarantee for Performance Security
PG4 – 10	Bank Guarantee for Advance Payment

Forms PG4-1 to PG4-6 comprises part of the Tender and should be completed as stated in ITT Clause 21.

Forms PG4-7 to PG4-10 comprises part of the Contract as stated in GCC Clause 5.

Tender Submission Letter (Form PG4 – 1)

[This letter shall be completed and signed by the Authorized Signatory on the Letter-Head pad of the Tenderer]

To: <i>[Contact Person]</i> <i>[Name of Purchaser]</i> <i>[Address of Purchaser]</i>	Date:
Invitation for Tender No:	<i>[indicate IFT No]</i>
Tender Package No:	<i>[indicate Package No]</i>
Lot No:	<i>[indicate number of Lots]</i>

We, the undersigned, offer to supply in conformity with the Tender Document the following Goods and related Services:

In accordance with ITT Clauses 23 and 24, the following prices and discounts apply to our Tender:

The Tender Price is: (ITT Sub-Clause 23.1)	<i>a. BDT [state amount in figures] [state amount in words]</i>
	<i>b. Other Currency(s) [state amount in figures] [state amount in words] as stated in the TDS Sub-Clause 24.3</i>
In Accordance with ITT sub clause 23.9 (a) and 23.9 (b) the unconditional discount offered by us is: (This discount shall be applicable on all the items of Price Schedule after Arithmetical Correction)	_____ <i>[Percentage in figures and words]</i>
The advance payment (when applicable) is: <i>[insert the percentage of the Contract Price]</i> (GCC Sub-Clause 27.1)	_____ <i>[Percentage in figures and words]</i>
and we shall accordingly submit an Advance Payment Guarantee in the format shown in Form PG4-10 .	
Mandatory Spare Parts Price (When Economic Factor applicable) is: (ITT Sub-Clause 52.2 (f) & 52.5 (b))	BDT _____ <i>[in figures]</i>
	BDT _____ <i>[in words]</i>

and we shall accordingly submit an Advance Payment Guarantee in the format shown in Form PG4 - 10.

In signing this letter, and in submitting our Tender, we also confirm that:

- a) our Tender shall be valid for the period stated in the Tender Data Sheet (ITT Sub-Clause 27.2) and it shall remain binding upon us and may be accepted at any time before the expiration of that period;
- b) a Tender Security is attached in the form of a bank guarantee in the amount stated in the Tender Data Sheet (ITT Clause 29) and valid for a period of 28 days beyond the Tender validity date;
- c) if our Tender is accepted, we commit to furnishing a Performance Security in the amount stated in the Tender Data Sheet (ITT Sub-Clause 63.2) in the form stated in Tender Data Sheet (ITT Sub-Clause 64.1) and valid for a period of 28 days beyond the date of completion of our performance obligations;
- d) we have examined and have no reservations to the Tender Document, issued by you on *[insert date]*;

including Addendum to Tender Documents No(s) *[state numbers]*, issued in accordance with the Instructions to Tenderers (ITT Clause 11). *[insert the number and issuing date of each addendum; or delete this sentence if no Addendum have been issued]*;
- e) we, including as applicable, subcontractor for any part of the contract resulting from this Tender process, have nationalities from eligible countries, in accordance with ITT Sub-Clause 5.1;
- f) we are submitting this Tender as a sole Tenderer
- g) we are not a Government owned entity as defined in ITT Sub-Clause 5.3
or
we are a Government owned entity, and we meet the requirements of ITT Sub-Clause 5.3];
(delete one of the above as appropriate)
- h) we, declare that we are not associated, nor have been associated in the past, directly or indirectly, with a consultant or any other entity that has prepared the design, specifications and other documents, in accordance with ITT Sub-Clause 5.5;
- i) we, including as applicable subcontractor, have not been declared ineligible by the Government of Bangladesh or the Development Partner, under the laws of Bangladesh or official regulations or by an act of compliance with a decision of the United Nations Security Council on charges of engaging in corrupt, fraudulent, collusive, coercive (or obstructive in case of Development Partner) practices, in accordance with ITT Sub-Clause 5.6;
- j) furthermore, we are aware of ITT Sub Clause 4.3 concerning such practices and pledge not to indulge in such practices in competing for or in executing the Contract;
- k) we intend to subcontract an activity or part of the Supply, in accordance with ITT Sub-Clause 16.1 to the following Subcontractor(s);

Nature of the Supply or related service	Name and address of Subcontractor

- l) we, confirm that we do not have a record of poor performance, such as abandoning the Supply, not properly completing contracts, inordinate delays, or financial failure as stated in ITT Sub-Clause 5.8, and that we do not have, or have had, any litigation against us, other than that stated in the Tenderer Information Sheet(Form PG4-2);

- m) we are not participating as Tenderers in more than one Tender in this Tendering process. We understand that your written Notification of Award shall become a binding Contract between us, until a formal Contract is prepared and executed;

- n) we understand that you reserve the right to accept or reject any Tender, to cancel the Tender proceedings, or to reject all Tenders, without incurring any liability to Tenderers, in accordance with ITT Clause 58.1.

Signature:

<i>[insert signature of authorized representative of the Tenderer]</i>
--

Name:

<i>[insert full name of signatory with National ID]</i>

In the capacity of:

<i>[insert designation of signatory]</i>
--

Duly authorized to sign the Tender for and on behalf of the Tenderer

[If there is more than one (1) signatory add other boxes and sign accordingly].

Attachment 1: Written confirmation authorizing the above signatory(ies) to commit the Tenderer, in accordance with ITT Sub-Clause 34.3;

<ul style="list-style-type: none"> □ <i>A certificate issued by the competent authority of Bangladesh stating that the Tenderer is a Tax payer having valid Tax identification Number (TIN) and VAT registration number or in lieu any other document acceptable to the Purchaser demonstrating that the Tenderer is a genuine Tax payer and has a VAT registration number as a proof of fulfillment of taxation obligations in accordance with ITT Clause 5 .</i> □ <i>Documentary evidence demonstrating that they are enrolled in the relevant professional or trade organizations registered in Bangladesh in accordance with ITT Clause 5.</i> 		
<p>2. Litigation History: <i>[Number of arbitration awards against the tenderer over the period in accordance the ITT Clause 13.1] if no [state “None”]</i></p>		
<p>3. Qualification Information of the Tenderer:</p>		
3.1	<p><i>Number of years of overall experience of the Tenderer in the supply of goods and related services as stated under ITT Sub-Clause 14.1(a):</i></p>	
3.2	<p><i>Number of completed supply contracts in the supply of similar goods and related services of required value within the period mentioned in TDS as stated under ITT Sub-Clause 14.1(b):</i></p> <ul style="list-style-type: none"> ▪ <i>Number of Contracts:</i> ▪ <i>Value of the Contracts:</i> ▪ <i>Period of the Contract:</i> 	
3.3	<p><i>The supply and/or production capacity of Goods, if applicable, as stated under ITT Sub-Clause 14.(c)</i></p>	
3.4	<p><i>Available liquid assets or working capital or credit facility in accordance with ITT Clause 15.1(a)</i></p>	

Subcontractor Information (Form PG4-2A)

[This Form should be completed by each Subcontractor, preferably on its Letter-Head Pad]

Invitation for Tender No: [IFT No]
 Tender Package No [Package No]
 Lot No. (when applicable) [Lot No]

1. Eligibility Information of the Subcontractor <i>[ITT Clause 5 and 26]</i>		
1.1	Nationality of Individual or country of Registration	
1.2	Subcontractor's legal title	
1.3	Subcontractor's registered address	
1.4	Subcontractor's legal status <i>[complete the relevant box]</i>	
	Proprietorship	
	Partnership	
	Limited Liability Concern	
	Government-owned Enterprise	
	Other (please describe)	
1.5	Subcontractor's year of registration	
1.6	Subcontractor's authorised representative details	
	Name	
	Address	
	Telephone / Fax numbers	
	e-mail address	
1.7	Subcontractor to attach copies of the following original documents	All documents to the extent relevant to ITT Clause 5 and 26 in support of its eligibility
The following two information are applicable for national Subcontractors		
1.8	Subcontractor's Value Added Tax Registration (VAT) Number	
1.9	Subcontractor's Tax Identification Number (TIN)	

[The foreign Subcontractors, in accordance with ITT Sub Clause 5.1, shall provide evidence by a written declaration to that effect to demonstrate that it meets the criterion]

2. Key Activity(ies) for which it is intended to be Subcontracted [ITT Sub Clause 16.1]

2.1	Elements of Activity	Brief description of Activity	
2.2	List of Similar Contracts in which the proposed Subcontractor had been engaged		
	Name of Contract and Year of Execution		
	Value of Contract		
	Name of Procuring Entity		
	Contact Person and contact details		
	Type of Good supplied or service provided or Works performed		

Price Schedule for Goods (Form PG4-3A)
[Group A Tenders: Goods Manufactured in Bangladesh]

Invitation for Tender No:		Date:	
Tender Package No:		Package Description:	<i>[enter description as specified in Section 6]</i>
Tender Lot No:		Lot Description:	<i>[enter description as specified in Section 6]</i>

1 Line Item No.	2 Description of Item	3 Unit of Measurement	4 Quantity	5 Unit price EXW Excluding VAT <i>[FC or BDT]</i>	6 EXW price per Line Item (Col. 4 × 5) <i>[FC or BDT]</i>	7 Inland transportation, Insurance and other local costs for the delivery of the Goods to their final destination <i>[BDT]</i>	8 Cost of local labour, raw materials and components from with origin in Bangladesh	9 VAT Payable on account of Supplier if the Contract is awarded <i>[BDT]</i>	10 Total Price per line item (Col. 6+7)	
									FC	BDT
<i>[Insert number of the item]</i>	<i>[Insert name of Goods]</i>	<i>[Insert name of the Unit]</i>	<i>[Insert number of Unit to be supplied]</i>	<i>[Insert EXW unit price, also indicate Currency]</i>	<i>[Insert total EXW price per line item]</i>	<i>[Insert corresponding price per line item]</i>	<i>[Insert cost of local labour, raw material and components as a % of the Col 5]</i>	<i>[Insert Supplier's VAT if Contract is awarded]</i>	<i>[Insert total price per line item]</i>	
1	28" Cutter Suction Dredger	Nos.	02							
2	HDPE Floating Pipe for 28" Cutter Suction Dredger	meter	3000							
3	Foam type floater for 28" Cutter Suction Dredger	Nos.	1000							
4	HDPE Shore Pipe for 28" Cutter Suction Dredger	meter	5000							

5	Ball Socket for 28" Cutter Suction Dredger	Pairs	80						
6	Rubber Hose Pipe for 28" Cutter Suction Dredger	Nos.	150						
7	Spare parts for 28" Cutter Suction Dredger	LS							
8	Crane Boat for 28" Cutter Suction Dredger	Nos.	02						
9	Spare Parts for Crane Boat Of 28" Cutter Suction Dredger	LS							
10	F. S Wire Rope (Different sizes) (each coil 300 m)	Coil	100						
Note: Price offered in foreign currency (FC) & Bangladeshi Taka BDT								Total Price for Lot	
Point of Delivery as per Schedule of Requirement:						Period of Delivery as per Schedule of Requirement:			

Name:	<i>[insert full name of signatory]</i>	<i>Signature with Date and Seal</i>
In the capacity of:	<i>[insert designation of signatory]</i>	<i>[Sign]</i>
Duly authorised to sign the Tender for and on behalf of the Tenderer		

Price Schedule for Goods (Form PG4-3B)

[Group B Tenders: Goods Manufactured outside Bangladesh, to be imported]

Invitation for Tender No:		Date:	
Tender Package No:		Package Description:	<i>[enter description as specified in Section 6]</i>
Tender Lot No:		Lot Description:	<i>[enter description as specified in Section 6]</i>

1	2	3	4	5	6	7	8	9	10	
Line Item No .	Description of Item	Country of Origin	Unit of Measurement	Quantity	Unit price CIF[Chittagong port/Mongla port] Or CIP[Chittagong port/Mongla port] [FC]	CIF/CIP price per Line Item (Col. 5 × 6) [FC]	Inland transportation, Insurance and other local costs for the delivery of the Goods to their final destination [BDT]	VAT Payable on account of Supplier if the Contract is awarded [BDT]	Total Price per line item (Col. 7+ Col. 8)	
									FC	BDT
<i>[Insert number of the item]</i>	<i>[Insert name of Goods]</i>	<i>[insert country of origin of the</i>	<i>[Insert name of the Unit]</i>	<i>[Insert number of Unit to be</i>	<i>[Insert unit price in CIF or CIP, also indicate currency]</i>	<i>[Insert total price per line item]</i>	<i>[Insert corresponding price per line item]</i>	<i>[Insert Supplier's VAT if Contract is awarded]</i>	<i>[Insert total price per line item]</i>	
1	28" Cutter Suction		Nos.	02						
2	HDPE Floating Pipe for 28" Cutter Suction Dredger		meter	3000						
3	Foam type floater for 28" Cutter Suction Dredger		Nos.	1000						

1	2	3	4	5	6	7	8	9	10	
Line Item No .	Description of Item	Country of Origin	Unit of Measurement	Quantity	Unit price CIP[Chittagong port/Mongla port] Or CIF[Chittagong port/Mongla port] [FC]	CIF/CIP price per Line Item (Col. 5 × 6) [FC]	Inland transportation, Insurance and other local costs for the delivery of the Goods to their final destination [BDT]	VAT Payable on account of Supplier if the Contract is awarded [BDT]	Total Price per line item (Col. 7+ Col. 8) FC BDT	
<i>[Insert number of the item]</i>	<i>[Insert name of Goods]</i>	<i>[insert country of origin of the</i>	<i>[Insert name of the Unit]</i>	<i>[Insert number of Unit to be</i>	<i>[Insert unit price in CIF or CIP, also indicate currency]</i>	<i>[Insert total price per line item]</i>	<i>[Insert corresponding price per line item]</i>	<i>[Insert Supplier's VAT if Contract is awarded]</i>	<i>[Insert total price per line item]</i>	
4	HDPE Shore Pipe for 28" Cutter Suction		meter	5000						
5	Ball Socket for 28" Cutter Suction		Pairs	80						
6	Rubber Hose Pipe for 28" Cutter Suction		Nos.	150						
7	Spare parts for 28" Cutter Suction		LS	-						
8	Crane Boat for 28" Cutter Suction		Nos.	02						
9	Spare Parts for Crane Boat of 28" Cutter		LS	-						

1	2	3	4	5	6	7	8	9	10	
Line Item No .	Description of Item	Country of Origin	Unit of Measurement	Quantity	Unit price CIP[Chittagong port/Mongla port] Or CIF[Chittagong port/Mongla port] [FC]	CIF/CIP price per Line Item (Col. 5 × 6) [FC]	Inland transportation, Insurance and other local costs for the delivery of the Goods to their final destination [BDT]	VAT Payable on account of Supplier if the Contract is awarded [BDT]	Total Price per line item (Col. 7+ Col. 8) FC BDT	
<i>[Insert number of the item]</i>	<i>[Insert name of Goods]</i>	<i>[insert country of origin of the</i>	<i>[Insert name of the Unit]</i>	<i>[Insert number of Unit to be</i>	<i>[Insert unit price in CIF or CIP, also indicate currency]</i>	<i>[Insert total price per line item]</i>	<i>[Insert corresponding price per line item]</i>	<i>[Insert Supplier's VAT if Contract is awarded]</i>	<i>[Insert total price per line item]</i>	
10	F. S Wire Rope (Different sizes) (each coil 300 m)		Coil	100						
Note : Price offered in foreign currency (FC) & Bangladeshi Taka(BDT)							Total Price for Lot			
Point of Delivery as per Schedule of Requirement:						Period of Delivery as per Schedule of Requirement:				

<i>The</i>	Name:	<i>[insert full name of signatory]</i>	<i>Signature with Date and Seal</i>
	In the capacity of:	<i>[insert designation of signatory]</i>	<i>[Sign]</i>
	Duly authorised to sign the Tender for and on behalf of the Tenderer		

[Note:

Purchaser may also use other INCOTERMs, if deemed necessary, In such case Form PG4-3B, will require to be customized by the Purchaser]

Price Schedule for Goods (Form PG4-3C)

[Group B Tenders: Goods Manufactured outside Bangladesh, already imported]

Invitation for Tender No:		Date:	
Tender Package No:		Package Description:	<i>[enter description as specified in Section 6]</i>
Tender Lot No:		Lot Description:	<i>[enter description as specified in Section 6]</i>

1	2	3	3	4	5	6	7	8	9	10	11
Line Item No .	Description of Item	Country of Origin	Unit of Measurement	Quantity	Unit price Including Custom Duties, import VAT & other import taxes already paid [BDT]	Custom Duties, import VAT & other import taxes already paid per unit [BDT]	Unit Price per line item net of Custom Duties, import VAT & other import taxes already paid [BDT] (Col. 5 – Col.6)	Price per line item net of Custom Duties, import VAT & other import taxes already paid [BDT] (Col. 4X Col. 7)	Inland transportation, Insurance and other local costs for the delivery of the Goods to their final destination [BDT]	VAT Payable on account of Supplier if the Contract is awarded [BDT]	Total Price per line item (Col.8+ Col.9) [BDT]
<i>[Insert number of the item]</i>	<i>[Insert name of Goods]</i>	<i>[insert country of origin of the Good]</i>	<i>[Insert name of the Unit]</i>	<i>[Insert number of Unit to be supplied]</i>	<i>[Insert unit price including CD & all import taxes]</i>	<i>[Insert CD, VAT & import taxes paid per unit] to be supported by</i>	<i>[insert unit price net of CD, VAT and import taxes]</i>	<i>[insert price per line item net of CD, VAT and import taxes]</i>	<i>[Insert corresponding price per line item]</i>	<i>[Insert Supplier's VAT if Contract is awarded]</i>	<i>[Insert total price per line item]</i>
Not Applicable											
Note : Price offered in Bangladesh Taka							Total Price for Lot				
Point of Delivery as per Schedule of Requirement:						Period of Delivery as per Schedule of Requirement:					

Name:	<i>[insert full name of signatory]</i>	<i>Signature with Date and Seal</i>
In the capacity of:	<i>[insert designation of signatory]</i>	<i>[Sign]</i>
Duly authorised to sign the Tender for and on behalf of the Tenderer		

Price and Completion Schedule - Related Services (Form PG4-3D)

Invitation for Tender No:		Date:	
Tender Package No:		Package Description:	<i>[enter description as specified in Section 6]</i>
Tender Lot No:		Lot Description:	<i>[enter description as specified in Section 6]</i>

1 Service No.	2 Description of Services (excludes inland transportation and other services required in Bangladesh to convey the goods to their final destination)	3 Country of Origin	4 Unit of Measurement	5 Quantity	6 Unit price of service [FC] or [BDT]	7 Price per line item of service (Col. 5 X Col. 6) [FC] or [BDT]	8 VAT Payable on account of Supplier if the Contract is awarded [BDT]	9 Total Price per line item of service (Col. 7)	
								FC	BDT
<i>[insert number]</i>	<i>[insert name of Services]</i>	<i>[insert country of origin of the Service]</i>	<i>[Insert name of the Unit]</i>	<i>[Insert number of Unit to be supplied]</i>	<i>[Insert unit price]</i>	<i>[Insert price per line item of service]</i>	<i>[Insert Supplier's VAT if Contract is awarded]</i>	<i>[Insert total price per line item of service]</i>	
01	<i>Plan approval and survey work including supervision of Dredger by Classification Society of Lloyds/ABS/NKK/DNV.GL</i>		<i>Job</i>	<i>02</i>					
02	<i>Plan approval and survey work including supervision of crane boat by Classification Society of Lloyds/ABS/NKK/ DNV.GL</i>		<i>Job</i>	<i>02</i>					

03	Specification survey of HDPE Shore pipe, HDPE Floating Pipe, Foam type Floater, Ball Socket, Spare parts, Rubber Hose Pipe & F.S Wire Rope by Classification Society of Lloyds/ABS/NKK/ DNV.GL		Job	01				
Note Price offered in foreign currency (FC) & Bangladesh Taka(BDT)						Total Price for Lot		
Point of Delivery as per Schedule of Requirement:				Period of Delivery as per Schedule of Requirement:				

Name:	<i>[insert full name of signatory]</i>	<i>Signature with Date and Seal</i>
In the capacity of:	<i>[insert designation of signatory]</i>	<i>[Sign]</i>
Duly authorised to sign the Tender for and on behalf of the Tenderer		

Specifications Submission and Compliance Sheet (Form PG4-4)

Invitation for Tender No:

Date:

Tender Package No:

Package Description: *[enter description as specified in Section 6]*

Tender Lot No:

Lot Description: *[enter description as specified in Section 6]*

Item No.	Name of Goods or Related Service	Country of Origin	Make and Model (when applicable)	Full Technical Specifications and Standards
1	2	3	4	5
	FOR GOODS			Note 1

[The Tenderer should complete all the columns as required]

Signature:

<i>[insert signature of authorised representative of the Tenderer]</i>
<i>[insert full name of signatory]</i>
<i>[insert designation of signatory]</i>

Name:

In the capacity of:

Duly authorised to sign the Tender for and on behalf of the Tenderer

Manufacturer's Authorisation Letter (Form PG4 - 5)

[The Tenderer shall require the Manufacturer to fill in this Form in accordance with the instructions indicated. This letter of authorization should be on the letterhead of the Manufacturer and should be signed by a person with the proper authority to sign documents that are binding on the Manufacturer. The Tenderer shall include it in its tender, if so indicated in the TDS as stated under ITT Sub-Clause 26.1(b)]

Invitation for Tender No:	Date:
Tender Package No:	
Tender Lot No:	
To: Name and address of Purchaser]	

WHEREAS

We *[insert complete name of Manufacturer]*,

who are official manufacturers of *[insert type of goods manufactured]*, having factories at *[insert full address of Manufacturer's factories]*, do hereby

authorize *[insert complete name of Tenderer]* to supply the following Goods, manufactured by us *[insert name and or brief description of the Goods]*.

We hereby extend our full guarantee and warranty as stated under GCC Clause 33 of the General Conditions of Contract, with respect to the Goods offered by the above Tenderer.

Signed: *[insert signature(s) of authorized representative(s) of the Manufacturer]*

Name: *[insert complete name(s) of authorized representative(s) of the Manufacturer]*

Address: *[insert full address including Fax and e-mail]*

Title: *[insert title]*

Date: *[insert date of signing]*

Bank Guarantee for Tender Security (Form PG4 – 6)

[this is the format for the Tender Security to be issued by a scheduled bank of Bangladesh as stated under ITT Clauses 29 and 30]

Invitation for Tender No:

Date:

Tender Package No:

Tender Lot No:

To:

[Name and address of Purchaser]

TENDER GUARANTEE No:

We have been informed that *[insert name of Tenderer]* (hereinafter called “the Tenderer”) intends to submit to you its Tender dated *[insert date of Tender]* (hereinafter called “the Tender”) for the supply of *[description of goods and related services]* under the above Invitation for Tenders (hereinafter called “the IFT”).

Furthermore, we understand that, according to your conditions, Tenders must be supported by a Bank Guarantee for Tender Security .

At the request of the Tenderer, we *[insert name of bank]* hereby irrevocably undertake to pay you, without cavil or argument, any sum or sums not exceeding in total an amount of Bangladeshi Taka(BDT) *[insert amount in figures and in words]* upon receipt by us of your first written demand accompanied by a written statement that the Tenderer is in breach of its obligation(s) under the Tender conditions, because the Tenderer:

- a. has withdrawn its Tender after opening of Tenders but within the validity of the Tender Security ; or
- b. refused to accept the Notification of Award (NOA) within the period as stated under Instructions to Tenderers (ITT) ; or
- c. failed to furnish Performance Security within the period as stipulated in the NOA; or
- d. refused to sign the Contract Agreement by the time specified in the NOA; or
- e. did not accept the correction of the Tender price following the correction of the arithmetic errors in accordance with the ITT; or

This guarantee will expire:

- (a) if the Tenderer is the successful Tenderer, upon our receipt of a copies of the contract signed by the Tenderer and the Performance Security issued to you in accordance with the ITT; or
- (b) if the Tenderer is not the successful Tenderer, twenty eight (28) days after the expiration of the Tenderer’s Tender validity period, being *[date of expiration of the Tender validity plus twenty eight(28) days]*

Consequently, we must receive at the above-mentioned office any demand for payment under this guarantee on or before that date.

Signature

Seal

Letter of Commitment for Bank's Undertaking for Line of Credit (Form PG4-6A)

[This is the format for the Credit Line to be issued by any internationally reputable bank in accordance with ITT Clause 26.1(d)]

Memo No.:

Date:

Invitation for Tender No:

Date:

Tender Package No:

Lot No (*when applicable*):

To:

[Name and address of the Procuring Entity]

CREDIT COMMITMENT No: *[insert number]*

We have been informed that *[name of Tenderer]* (hereinafter called "the Tenderer") intends to submit to you its Tender (hereinafter called "the Tender") for the supply of Goods of *[description of Goods and related services]* under the above Invitation for Tenders (hereinafter called "the IFT").

Furthermore, we understand that, according to your conditions, the Tenderer's Financial Capacity i.e. Liquid Asset must be substantiated by a Letter of Commitment of Bank's Undertaking for Line of Credit.

At the request of, and arrangement with, the Tenderer, we *[name and address of the Bank]* do hereby agree and undertake that *[name and address of the Tenderer]* will be provided by us with a revolving line of credit, in case awarded the Contract, for the delivery of Goods and related services viz. *[insert name of supply]*, for an amount not less than *[name of currency(s)] [Amount in figure] (in words)* for the sole purpose of the supply of Goods and related services under the above Contract. This Revolving Line of Credit will be maintained by us until issuance of "**Acceptance Certificate**" by the Procuring Entity.

In witness whereof, authorised representatives of the Bank have hereunto signed and sealed this Letter of Commitment.

Name and Signature

Name and Signature

Notification of Award (Form PG4 - 7)

Contract No:
To:

Date:

[Name of Contractor]

This is to notify you that your Tender dated *[insert date]* for the supply of Goods and related Services for *[name of contract]* for the Contract Price of Tk *[state amount in figures and in words]* as corrected and modified in accordance with the Instructions to Tenderers, has been approved by *[name of Purchaser]*.

You are thus requested to take following actions:

- i. accept in writing the Notification of Award within seven (7) working days of its issuance pursuant to ITT Sub-Clause 62.3
- ii. furnish a Performance Security in the specified format and in the amount of Tk *[state amount in figures and words]* ,within Twenty-eight (28) days from issue of this Notification of Award but not later than *(specify date)*, in accordance with ITT Clause 64.2
- iii. sign the Contract within twenty eight (28) days of issuance of this Notification of Award but not later than *(specify date)*, in accordance with ITT Clause 67.2

You may proceed with the execution of the supply of Goods and related Services only upon completion of the above tasks. You may also please note that this Notification of Award shall constitute the formation of this Contract, which shall become binding upon you.

We attach the draft Contract and all other documents for your perusal and signature.

Signed

Duly authorised to sign for and on
behalf of *[name of Purchaser]*

Date:

Contract Agreement (Form PG4 - 8)

THIS AGREEMENT made the [day] day of [month] [year] between [name and address of Purchaser] (hereinafter called "the Purchaser") of the one part and [name and address of Supplier] (hereinafter called "the Supplier") of the other part:

WHEREAS the Purchaser invited Tenders for certain goods and related services, viz, [brief description of goods and related services] and has accepted a Tender by the Supplier for the supply of those goods and related services in the sum of BDT [Contract Price in figures and in words] (hereinafter called "the Contract Price").

NOW THIS AGREEMENT WITNESSETH AS FOLLOWS:

1. In this Agreement words and expressions shall have the same meanings as are respectively assigned to them in the General Conditions of Contract hereafter referred to.
2. The following documents forming the Contract shall be in the following order of precedence, namely :
 - (a) the signed Form of Contract Agreement;
 - (b) the Notification of Award
 - (c) The Tender and the appendices to the Tender
 - (d) Particular Conditions of Contract;
 - (e) General Conditions of Contract;
 - (f) Technical Specifications;
 - (g) Drawings;
 - (h) Price Schedules and Schedule of Requirements and;
 - (i) other document including correspondences listed in the PCC forming part of the Contract
3. In consideration of the payments to be made by the Purchaser to the Supplier as hereinafter mentioned, the Supplier hereby covenants with the Purchaser to provide the goods and related services and to remedy any defects therein in conformity in all respects with the provisions of the Contract.
4. The Purchaser hereby covenants to pay the Supplier in consideration of the provision of the goods and related services and the remedying of defects therein, the Contract Price or such other sum as may become payable under the provisions of the Contract at the times and in the manner prescribed by the Contract.

IN WITNESS whereof the parties hereto have caused this Agreement to be executed in accordance with the laws of Bangladesh on the day, month and year first written above.

For the Purchaser:

For the Supplier:

Signature

Print Name

Title

In the presence
of Name
Address

Bank Guarantee for Performance Security (Form PG4 – 9)

*[This is the format for the Performance Security to be issued by **an internationally reputable bank and it shall have correspondent bank located in Bangladesh, to make it enforceable in accordance with ITT Sub-Clause 64.1 pursuant to Rule 27(4) of the Public Procurement Rules, 2008.]***

Contract No:

Date:

To:

[Name and address of Purchaser]

PERFORMANCE GUARANTEE No: *[insert Performance Guarantee number]*

We have been informed that *[name of supplier]* (hereinafter called “the Supplier”) has undertaken, pursuant to Contract No *[reference number of Contract]* dated *[date of Contract]* (hereinafter called “the Contract”) for the supply of *[description of goods and related services]* under the Contract.

Furthermore, we understand that, according to your conditions, Contracts must be supported by a performance guarantee.

At the request of the Supplier, we *[name of bank]* hereby irrevocably undertake to pay you, without cavil or argument, any sum or sums not exceeding in total an amount of Tk *[insert amount in figures and in words]* upon receipt by us of your first written demand accompanied by a written statement that the Supplier is in breach of its obligation(s) under the Contract conditions, without you needing to prove or show grounds or reasons for your demand of the sum specified therein.

This guarantee is valid until *[date of validity of guarantee]*, consequently, we must receive at the above-mentioned office any demand for payment under this guarantee on or before that date.

[Signatures of authorized representatives of the bank]

Signature

Seal

Bank Guarantee for Stage Payment (Form PG4 – 10)

Contract No:

Date:

To:

[Name and address of Purchaser]

STAGE PAYMENT GUARANTEE No:

We have been informed that *[name of supplier]* (hereinafter called “the Supplier”) has undertaken, pursuant to Contract No *[reference number of Contract]* dated *[date of Contract]* (hereinafter called “the Contract”) for the supply of *[description of goods and related services]* under the Contract.

Furthermore, we understand that, according to your Particular Conditions of Contract Clause 26.1, Stage Payment(s) on Contracts must be supported by a bank guarantee.

At the request of the Supplier, we *[name of bank]* hereby irrevocably undertake to pay you, without cavil or argument, any sum or sums not exceeding in total an amount of Tk *[insert amount in figures and in words]* upon receipt by us of your first written demand accompanied by a written statement that the Supplier is in breach of its obligation(s) under the Contract conditions, without you needing to prove or show grounds or reasons for your demand of the sum specified therein.

We further agree that no change, addition or other modification of the terms of the Contract to be performed, or of any of the Contract documents which may be made between the Purchaser and the Supplier, shall in any way release us from any liability under this guarantee, and we hereby waive notice of any such change, addition or modification.

This guarantee is valid until *[date of validity of guarantee]*, consequently, we must receive at the above-mentioned office any demand for payment under this guarantee on or before that date.

[Signatures of authorized representatives of the bank]

Signature

Seal

Section 6. Schedule of Requirements

Invitation for Tender No:
Tender Package No:

Date

A. List of Goods and Delivery Schedule

When completing Form PG4-3A, 3B & 3C the Tenderer shall quote prices and contract delivery dates, as specified in the List of Goods and Delivery Schedule.

Item No.	Description of Item	Unit of Measurement	Quantity	Point of Delivery [Final (Project Site) Destination as specified in TDS]	Delivery Date Required (in months)	
					6	7
1	2	3	4	5	6	7
1	28" Cutter Suction Dredger	Nos.	02	Dredger Base, BIWTA, Narayanganj	18 (Eighteen) months from the date of signing of contract	
2	HDPE Floating Pipe for 28" Cutter Suction Dredger	meter	3000			
3	Foam type floater for 28" Cutter Suction Dredger	Nos.	1000			
4	HDPE Shore Pipe for 28" Cutter Suction Dredger	meter	5000			
5	Ball Socket for 28" Cutter Suction Dredger	Pairs	80			
6	Rubber Hose Pipe for 28" Cutter Suction Dredger	Nos.	150			
7	Spare parts for 28" Cutter Suction Dredger	LS	-			
8	Crane Boat for 28" Cutter Suction Dredger	Nos.	02			
9	Spare Parts for Crane Boat of 28" Cutter Suction Dredger	LS	-			
10	F. S Wire Rope (Different sizes) (each coil 300 m)	Coil	100			

B. List of Related Services and Completion Schedule

When completing Form PG4-3D, the Tenderer shall quote prices and Completion date for services for each item against each lot

Item No.	Description of Item	Unit of Measurement	Quantity	Place where Services shall be performed	Final Completion Date(s) of Services
1	2	3	4	5	6
					<i>[insert required Completion Date(s)]</i>
01	<i>Plan approval and survey work including supervision of Dredger by Classification Society of Lloyds/ABS/NKK/DNV.GL</i>	<i>Job</i>	<i>02</i>		
02	<i>Plan approval and survey work including supervision of Crane boat by Classification Society of Lloyds/ABS/NKK/DNV.GL</i>	<i>Job</i>	<i>02</i>		
03	<i>Specification survey of HDPE Shore pipe, HDPE Floating Pipe, Foam type Floater, Ball Socket, Spare parts, Rubber Hose Pipe & F.S Wire Rope by Classification Society of Lloyds/ABS/NKK/ DNV.GL</i>	<i>Job</i>	<i>01</i>		
Lot No 1: [enter description]					
<i>[add as many rows and details as there are individual items in the Lot]</i>					
Lot No 2: [enter description]					
<i>[add as many rows and details as there are individual items in the Lot]</i>					

Section 7. Technical Specifications

The Goods shall comply with following Technical Specifications:

Item No	Name of Item or Related Service	Technical Specification and Standards
1	2	3
1	28" Cutter Suction Dredger	Details in Annex-I
2	HDPE Floating Pipe for 28" Cutter Suction Dredger	
3	Foam type floater for 28" Cutter Suction Dredger	
4	HDPE Shore Pipe for 28" Cutter Suction Dredger	
5	Ball Socket for 28" Cutter Suction Dredger	
6	Rubber Hose Pipe for 28" Cutter Suction Dredger	
7	Spare parts for 28" Cutter Suction Dredger	
8	Crane Boat for 28" Cutter Suction Dredger	
9	Spare Parts for Crane Boat of 28" Cutter Suction Dredger	
10	F. S Wire Rope (Different sizes) (each coil 300 m)	

Section 8. Drawings

Notes on Drawings

[Insert here a list of Drawings, including site plans, which should be attached to this section or annexed in a separate folder. The Drawings shall be clearly dated, numbered and show any revision number(s), if appropriate.]

General Arrangement (G.A) Plan of dredger & crane boat have been attached in Annex-3 & 4

FORMAT

LOGO

[Insert Full Contact Details of the Procuring Entity]

CONTRACT AMENDMENT

Contract No.	
Amendment No.	
Approval Reference No.	

Contract No. [insert number/year] by and between the [insert Procuring Entity's name] and [insert Supplier's legal title] for the contract named [insert name of the Goods and related services] is amended as follows:

1. GCC Clause [insert clause no], is hereby revised as _____

2. GCC Clause [insert clause no], is hereby revised as _____

and so on .

The effective date of this Amendment is [insert effective date] or upon execution whichever is later.

**ALL OTHER TERMS AND CONDITIONS OF THE ORIGINAL CONTRACT SHALL
REMAIN IN FULL FORCE AND EFFECT**

THIS AMENDMENT, consisting of [insert number] page(s) and [insert number] attachment(s), is executed by the persons signing below who warrant that they have the authority to execute this Amendment under the original Contract.

IN WITNESS WHEREOF, the Procuring Entity and the Supplier have signed this Amendment.

[Supplier's Authorized Signatory]

[Procuring Entity's Authorized Signatory]

Signature

Signature

Title

Date

Title

Date

FORMAT

LOGO

[Insert Full Contact Details of Issuing Authority]

Office Memo no: _____

Date: _____

ACCEPTANCE CERTIFICATE

01	Procuring Entity Details		
	(a) Division	:	
	(b) Circle/Directorate	:	
	(c) Zone/Region	:	
	(d) Others (<i>specify</i>)	:	
02	Name of Supply	:	
03	Contract No	:	
04	Supplier's Legal Title	:	
05	Supplier's Contact Details	:	
06	Supplier's Trade License/Enlistment/Registration Details	:	
07	Reference to NOA with Date	:	
08	Original Contract Price as in NOA	:	
09	Final Contract Price as Delivered	:	
10	Original Contract Period		
	(a) Date of Commencement	:	
	(b) Date of Completion	:	
11	Actual Delivery Period		
	(a) Date of Actual Commencement	:	
	(b) Date of Actual Completion	:	
12	Days/Months Delivery Period Extended	:	
13	Amount of LD for Delayed Delivery	:	
14	Special Note (<i>if any</i>)	:	

Certified that the Goods and related services under the Contract has been delivered and completed in all respects in strict compliance with the provisions of the Contract including all plans, designs, drawings, specifications and all modifications thereof as per direction and satisfaction of the Procuring Entity/Engineer-in Charge/Other (*specify*). All defects in the Goods reported during inspection and tests have been duly rectified or replaced.

Name and Signature of the Issuing Authority with Designation

please turn over

Technical Specification

A brief guideline specification of the cutter suction dredger with accessories is given here under. The tenderer has to submit detailed specification of each and every item with its description, drawing, data etc. as required.

Bangladesh is a tropical Country. As such all the equipment to be supplied should be suitable for climate of Bangladesh. The recorded temperature is in the range of 10°C to 40°C and relative humidity is in the range of 60% to 100%.

A. CUTTER SUCTION DREDGER, 28" (700 mm) discharge diameter.**A-1: PARTICULARS OF DREDGER**

Principal Particulars		Dimensions/Instructions
1.01	Principal Dimensions	
	Length over all (about)	60.00 m
	Breadth (about)	13.50 m
	Depth (about)	3.20 m
	Draught loaded (maximum)	2.00 m
	Superstructure height (max)	13.00 m, signal mast shall be Collapsible/Folding type to maintain the height.
1.02	Dredging Installation	
	Inner diameter of suction pipe	750/700 mm
	Inner diameter of discharge pipe	700 mm
	Discharge distance	2500 m
	Dredging width	
	at minimum depth (approx.)	75.00 m
	at maximum depth (approx.)	65.00 m
	Dredging Depth	
	Maximum (Not less than)	20.00 m at 50° ladder angle
	Minimum	4.00 m
	Pump production capacity (Solid output)	Minimum 2200 cubic meter/hour of solid at pipeline distance of 2500 m at 20m dredging depth, dredge material-medium sand and with in situ density of 1950 kg/m ³ . Volumetric concentration of in situ solid of 20% to 30%. The pump performance curve/production curve is to be submitted in the tender to support the output.
	Fuel oil bunker tank capacity	100000-150000 litres
	Fresh water tank capacity	Minimum 50000 litres

	Hydraulic oil tank capacity	Minimum 10000 litres
1.03	Dredge pump	<p>Double/Single wall Dredge pump of high efficiency proven model (having proven record of at least ten years) with wear resistant material construction of its wearing parts as to suit best performance in dredging.</p> <p>Dredge pump with proven efficiency of more than 85 percent when pumping water.</p> <p>Material hardness for pump casing, suction nozzle liner, suction and shaft cover wearing plates and impeller–55-65 HRC or equivalent.</p> <p>Country of Origin: EU Countries/UK/ USA/ Australia/ Canada/ Japan.</p>
1.04	Steel Work	<p>Steel for hull fabrication including super structures shall be class certified under which class vessel shall be built.</p> <p>All the stiffeners and steel plates must be certified by the Classification Society. Necessary documents/certificates must be provided to the purchaser for the evidence that all the MS plates and Stiffeners are certified by above mentioned class. The supplier must notify to the purchaser after opening of Letter of credit (LC) for procurement of MS plate & Stiffener.</p> <p>All welding consumables shall be particular class type approved under which ship will be built and from a reputed and well known source.</p>
1.05	Main Engine	
	Make	Heavy Duty Marine Engine of reputed make which shall be type approved by appointed classification society.
	Power	Appropriate Power (approx. 2300 KW) to produce dredge pump solid output of 2200 cubic metre/hour at a discharge distance of 2500 metre.
	Diesel engine RPM (not exceeding)	1800
	Rating	The Heavy Duty Marine engine should have the capability to run at rated speed up to 80% of the time or 10 hours out of 12 hours.
	Country of Origin, Country of Manufacture, Country of Assembly, Country of Shipment	EU Countries/ UK/USA/ Australia / Canada/ Japan.
	Other Features	Engine shall have the capability of monitoring engine parameters and percentage of load locally and remotely.
1.06	Auxiliary Engine	
	Make	Marine Engine of reputed make which shall be type approved by appointed classification society.
	Power	Appropriate Power (Approx. 1000KW) to suite necessary requirement for operation of hydraulic pumps, motors and components.

	Diesel engine RPM (maximum)	1800
	Rating	The Heavy Duty Marine engine should have the capability to run at rated speed up to 80% of the time or 10 hours out of 12 hours.
	Country of Origin, Country of Manufacture, Country of Assembly, Country of Shipment	EU Countries/ UK/USA/ Australia / Canada/ Japan.
	Other Features	Engine shall have the capability of monitoring engine parameters and percentage of load locally and remotely.
1.07	Main Generator & Emergency Generator sets (02 Nos.)	
	Make	Marine Engine of reputed make which shall be type approved by appointed classification society.
	Power	Appropriate Power (approximate 2 x 120KW, 400V, 50 Hz) to suit necessary requirement for operation of dredger.
	Diesel engine RPM (maximum)	1500
	Country of Origin, Country of Manufacture, Country of Assembly, Country of Shipment	EU Countries/ UK/USA/ Australia / Canada/ Japan.
1.08	Harbour Generator	
	Make	Marine Engine of reputed make which shall be type approved by appointed classification society.
	Power	Appropriate Power (approximate 50 KW, 400V, 50Hz) to suite necessary requirement for operation of hydraulic pumps, motors and other components.
	RPM (maximum)	1500
	Country of Origin, Country of Manufacture, Country of Assembly, Country of Shipment	EU Countries/ UK/USA/ Australia / Canada/ Japan.
1.09	Shore connection	
		Shore connection boxes for backup power supply when laying moored at a quay. Connection boxes for shore supply cable provided on both sides of engine room casing.
1.10	Cutter	
	Type	Crown type or equivalent
	Teeth	Replaceable teeth of chisel type. Teeth are locked by expandable locking pin.
	Speed	0-30 rpm (about)
	Drive	Cutter direct driven by low speed hydraulic motor. Cutter is fitted on the cutter shaft by means of screw thread.
	Material	Suitable for dredging sand.
1.11	Ladder gantry	
	Gantry construction	Sturdy ladder gantry shall be constructed from A-frame, made of thick-walled steel pipes. The gantry shall be dismantled from deck.

	Deck crane fore	Suitable Deck Crane fore (About 10.0 Ton) shall be positioned on the ladder gantry.
	Anchor booms	Anchor booms provided with turning point on deck and with pendant wire suspended from the box shaped ladder gantry.
1.12	Spuds	
	Diameter	Approx. 800 mm
	Length	26.00 m (minimum)
	Wall thickness	As required.
	Drive	Hydraulic ram
	Spud tilting facility	Spud tilting facility to be provided.
1.13	Spud carriage installation	
	Spud carriage	Spud carriage installation is to be fitted in complete set. This installation is to be operated by hydraulic rams or any other suitable system which can be controlled from the operating cabin. Any special tools required for assembly and disassembly is to be supplied.
1.14	Dredge winches	
	Swing winches	Swing winches are mounted on foundations on the superstructure in front of the operating cabin so that the operator has a clear view on the winch drums during dredge operation. Winches each driven by radial piston hydraulic motor via reduction gearbox.
	Ladder hoisting winch	Ladder winch mounted on foundation on the superstructure in front of the operating cabin and between the swing winches so that the operator has a clear view on the winch drum during dredge operation. Winches each driven by radial piston hydraulic motor via reduction gearbox and provided with fail safe brake.
	Anchor boom winches	Hydraulic driven anchor hoisting winches mounted on foundations on deck. Guy winches to be provided.
1.15	Deck Crane	
	Deck crane	Suitable Deck Crane with 15.0 Ton capacity is to be provided for maintenance of dredge pump and other components of dredger with electric driven mechanism. The Deck crane is subjected to classification society requirement & approval.
1.16	Class	<p>The vessels shall be designed and constructed under the applicable classification society rules. IACS 99- Recommendation for the safety of cargo vessels less than convention size for statutory aspects shall be considered.</p> <p>The vessel including its hull, Main propulsion and auxiliary engines, other equipment and machinery shall be designed, built classed for coastal water and manufactured under the supervision of reputed international classification society of Lloyds/ABS/NKK/DNV.GL being a member of IACS. The appropriate class notations for fully classed hull and machinery to be mentioned in the offer.</p> <p><u>Full Class Notation (Hull):</u> Means ship's hull design, hull materials used and constructions done under the proposed Classification society Special Survey in full compliance with the Rules and regulations. Hull notation shall be mentioned at the technical specification, Example- ✕100A1 or Equivalent.</p>

		<p>Full Class Notation (Machinery): Means all propelling and essential auxiliary machinery to be designed, constructed, installed and tested under Special Survey in accordance with proposed Classification society Rules and Regulations.</p> <p>Propelling and essential auxiliary machinery includes machinery, equipment and systems installed for the ship to be under seagoing conditions and that are necessary for the following:</p> <ol style="list-style-type: none"> a. Maintaining the watertight and weathertight integrity of the hull and spaces within the hull. b. The safety of the ship, machinery and personnel on board. c. The functioning and dependability of propulsion, steering and electrical systems. d. The operation and functioning of control engineering systems for the monitoring and safety of propulsion and steering systems. e. The operation and functioning of emergency machinery and equipment. <p>Machinery notation shall be mentioned at technical specification, Example- \timesLMC or Equivalent.</p> <p>The cost of the Classification society shall be borne by Purchaser through Supplier and the Classification society will fully responsible to the Purchaser for their work. Details responsibility of the Classification society has been attached in Annex-II. Price for this work shall be quoted in the price schedule for related services (Form PG4-3D). The total contract price shall be inclusive of the price of classification society.</p> <p>The following rules and regulations (if applicable) are to be complied with: Maritime Regulations of Bangladesh; SOLAS 1974 with latest amendments International Convention for the Prevention of Collision at Sea 1972 International Convention for Load Lines, 1966 IMO stability guideline including weather criteria Other rules and regulations applicable Registration & Survey (with Department of Shipping /Mercantile Marine Department of Bangladesh) must be completed by supplier's own cost`.</p>
1.17	Operating Cabin	<p>The Operating Cabin is to be properly insulated with air coolers fitted, considering high temperature of Bangladesh. The Cabin should be spacious enough for working 5-6 persons and to be provided with an adjustable chair for operator/dredge Master, writing desk with computer. All dredge controls, instrumentation, etc. are to be positioned in the control consoles and instrument panel. Instrument panel includes a.o. gland water pressure indicators, dredge pump vacuum pressure indicator and discharge pressure indicators, pressure indicators for hydraulic systems and HMI.</p>

		<p>Control consoles comprise operating devices for hydraulic equipment, dredge pump drives, alarm panel and other facilities required for operating of the dredger.</p> <p>The operating cabin is placed on vibration dampers on top of the engine room casing.</p> <p>All the wooden works of bridge deck including navigational panel should be of foreign made marine quality plywood/wood.</p> <p>Country of origin of plywood/wood- To be mentioned.</p> <p>Navigation light panels shall be class certified. Navigation lights shall be of class type approved.</p>
1.18	Accommodation space	<p>A day and night accommodation unit for 20 persons is placed on vibration dampers on main deck. The accommodation unit is provided with air conditioning. All watertight doors & windows should be Marine quality, class approved and class certified. Sanitary outfitting included in the accommodation space and consists of toilets and showers.</p> <p><u>Officers' accommodation</u></p> <p>Each consisting of a day cabin/sleeping room and a bathroom</p> <p><u>Each day cabin consists of</u></p> <ul style="list-style-type: none"> ▪ 1 U-shaped settee with integrated tables in the corner. ▪ 1 table with chair ▪ 1 desk lamp ▪ 1 cupboard ▪ Window curtain for each window ▪ 1 bedside lamp ▪ 1 TV (Minimum 42 inch) ▪ Other items as required. <p><u>Crew's accommodation (Each double berth crew's cabin)</u></p> <ul style="list-style-type: none"> ▪ 2 wardrobe ▪ 1 table with one chair ▪ Window curtain for each window or porthole ▪ 1 bedside lamp ▪ Other items as required. <p><u>Messroom</u></p> <ul style="list-style-type: none"> ▪ 2 dining table ▪ 12 chairs ▪ 1 low cupboard ▪ 1 medicine locker ▪ 1 cup rack ▪ 1 glass rack ▪ 1 curtain for each porthole ▪ 1 domestic refrigerator, net capacity approx 200 litres ▪ 1 LED TV (Minimum 48 inch). ▪ Other items as required. <p><u>Recreation area with cosy corner</u></p> <ul style="list-style-type: none"> ▪ 2 settees ▪ 1 saloon table ▪ 1 cupboard for TV and video equipment ▪ 1 TV. (Minimum 48 inch) ▪ Other items as required.

		<p><u>Galley</u></p> <ul style="list-style-type: none"> ▪ 1 stainless steel dresser with double sink and drawers underneath. ▪ 1 worktables for food preparation and wooden racks underneath. ▪ 1 stainless steel wall shelf ▪ 1 plate rack ▪ 1 pan rack ▪ 1 rack for cooking utensils ▪ 1 waste bin ▪ 6 extra electric connections for kitchen machines ▪ 1 domestic refrigerator, net capacity approx 500 litres ▪ Double Gas Burner ▪ Crockeries as required for 20 persons. ▪ Other items as required. <p>All the sanitary fittings should be of European Origin.</p>
1.19	Hydraulic system	<p>All hydraulic pump for cutter drive, ladder, spud, anchor boom, swing winch and emergency work to be provided as well as all motor for cutter drive, ladder, anchor boom and swing winch to be provided. All components of hydraulic system of proven design to be used for operation of winches, cutter, spuds etc. All components are to be of proven design for trouble free operation. Country of origin of design & components: EU Countries/UK/USA/ Australia/ Canada/ Japan. The hydraulic system shall be subjected to classification society requirement and approval.</p>
1.20	Anchors and chains	<p>Anchors: 4 Nos. @ 2500kg for each dredger, 8 Nos. @ 1500 kg for each dredger are to be provided for instant operation of the dredger. The anchors & chains should be subjected to classification society requirement and shall be class certified.</p>

1.21 Painting and Painting Schedule:

Painting thickness that are given below are of minimum value that is to be maintained for paint job

Paint Specification	Different Part of the Vessel	Color Code
<p><i>Welds will be brushed and painted with a first layer</i> Anti-Corrosive System Primer (1st coat) – 1x75µm Primer (2nd coat) – 1x75µm Epoxy Anticorrosive – 1x125µm Epoxy Tie Coat – 1x50 µm Self-polishing Anti-fouling – 1 x100 µm ----- TDFT = 425 µm</p>	<p>Bottom Plating & Shell Plating(U/W)</p>	<p>Red</p>

<p><i>Plate & Welds will be sand blasted, brushed and painted with a first layer</i></p> <p>Primer (1st coat) – 1x75µm Primer (2nd coat) – 1x75µm Recoatable Epoxy undercoat – 1x100 µm Recoatable Epoxy finish undercoat – 1x75 µm ----- TDFT = 325 µm</p>	Main Deck	GREEN
<p><i>Plate & Welds will be sand blasted, brushed and painted with a first layer</i></p> <p>Primer (1st coat) – 1x75µm Primer (2nd coat) – 1x75µm Recoatable Epoxy undercoat – 1x100 µm Recoatable Epoxy finish undercoat – 1x75 µm ----- TDFT = 325 µm</p>	Top Side (above water hull)	TURQUISE BLUE
<p><i>Plate & Welds will be sand blasted, brushed and painted with a first layer</i></p> <p>Primer (1st coat) – 1x75µm Primer (2nd coat) – 1x75µm Recoatable Epoxy undercoat – 1x100 µm Recoatable Epoxy finish undercoat – 1x75 µm ----- TDFT = 325 µm</p>	M/E & A/E hatch & Mast,	WHITE
<p><i>Plate & Welds will be sand blasted, brushed and painted with a first layer</i></p> <p>Primer (1st coat) – 1x75µm Primer (2nd coat) – 1x75µm Recoatable Epoxy undercoat – 1x100 µm Recoatable Epoxy finish undercoat – 1x75 µm ----- TDFT = 325 µm</p>	Ladder Gantry, David, Boom	YELLOW
<p><i>Plate & Welds will be sand blasted, brushed and painted with a first layer</i></p> <p>Primer (1st coat) – 1x75µm Recoatable Epoxy undercoat – 1x100 µm Recoatable Epoxy finish undercoat – 1x75 µm ----- TDFT = 250 µm</p>	Mixture Pipe & supports	GREY
<p><i>Plate & Welds will be sand blasted, brushed and painted with a first layer</i></p> <p>Primer (1st coat) – 1x75µm Primer (2nd coat) – 1x75µm Epoxy Anticorrosive – 1x125 µm Epoxy finish coat – 1x100 µm ----- TDFT = 375 µm</p>	Cutter Ladder	BLACK
<p><i>Plate & Welds will be sand blasted, brushed and painted with a first layer</i></p> <p>Primer (1st coat) – 1x75µm Primer (2nd coat) – 1x75µm Epoxy Anticorrosive – 1x125 µm Epoxy finish coat – 1x100 µm ----- TDFT = 375 µm</p>	Spud	BLACK

<p><i>Plate & Welds will be sand blasted, brushed and painted with a first layer</i></p> <p>Primer (1st coat) – 1x75 µm Primer (2nd coat) – 1x75 µm Epoxy finish coat – 1x40 µm Epoxy finish coat – 1x35 µm</p> <p>-----</p> <p style="text-align: center;">TDFT = 225 µm</p>	Control cabin, Mast & Stair wall	WHITE
<p><i>Plate & Welds will be sand blasted, brushed and painted with a first layer</i></p> <p>Primer (1st coat) – 1x75µm Primer (2nd coat) – 1x75µm Epoxy Anticorrosive – 1x125 µm Epoxy Anticorrosive – 1x125 µm</p> <p>-----</p> <p style="text-align: center;">TDFT = 400 µm</p>	Ballast tanks	GREY
<p><i>Plate & Welds will be sand blasted, brushed and painted with a first layer</i></p> <p>Primer (1st coat) – 1x75µm Primer (2nd coat) – 1x75µm Alkyd Finish Coat – 1x40 µm</p> <p>-----</p> <p style="text-align: center;">TDFT = 190 µm</p>	Hull internal	CREAM
<p><i>Plate & Welds will be sand blasted, brushed and painted with a first layer</i></p> <p>Primer (1st coat) – 1x75µm Primer (2nd coat) – 1x75µm Solvent free epoxy – 1x200 µm</p> <p>-----</p> <p style="text-align: center;">TDFT = 325 µm</p>	Fresh Water Tank	STANDARD
<p><i>Plate & Welds will be sand blasted, brushed and painted with a first layer</i></p> <p>Primer (1st coat) – 1x75µm</p> <p>Primer (2nd coat) – 1x75µm Epoxy Anticorrosive – 1x100 µm</p> <p>-----</p> <p style="text-align: center;">TDFT = 250 µm</p>	Hull internal (Dry Tanks)	GREY
<p><i>Plate & Welds will be sand blasted, brushed and painted with a first layer</i></p> <p>Primer (1st coat) – 1x75µm Epoxy Anticorrosive – 1x100 µm</p> <p>-----</p> <p style="text-align: center;">TDFT = 175 µm</p>	Hull internal (Fuel oil and Hydraulic Oil tanks)	STANDARD
<p><i>Plate & Welds will be sand blasted, brushed and painted with a first layer</i></p> <p>Minimum 1x100 Microns Silicon Zinc/Aluminum Heat Resisting Primer to temperatures up to 600°C. Minimum 2x100 Microns Acrylic Silicon Heat Resistant Finish Coat.</p>	Hull External (Exhaust Pipe and other Heat prone areas)	SILVER

Standard coating Should be applied	Piping system	Should be of international standard/ Surveyor's satisfaction
------------------------------------	----------------------	---

Recommendations:

1. All steel surface should be prepared to near white blasted of **SA 2 ½ Standard** as per standard surface preparation practice/methods.
2. Class approved marine paint should be used as per hull class – **Classification Society**
3. Standard paint scheme should be maintained as per paint manufacturer manual/recommendation.
4. Standard color should be maintained, other color should be approved by owner.
5. **Maintaining paint coating record file is mandatory** to ensure each and every film thickness of paint scheme.

1.22	Cathodic Protection	To be provided as per standard.
1.23	Pumps	All the pumps onboard should be subjected to classification society requirement and approval.
1.24	Piping & Valves	The dimensions and qualities of pipes shall be suitable for the purpose intended. The thickness of pipes and the dimensions of flanges shall be in accordance with the requirements of the Classification Society. Pipes shall be effectively supported or embraced to stand up to vibrations in the engine room and also well protected where liable to mechanical damages. With schematic drawing of pipe line detailed construction drawing shall be provided. All the valves onboard shall be subjected to classification society requirement & approval.
1.25	Other Installations and accessories	
	a) Swivel joint	To be provided with the discharge pipeline at the aft of the dredger.
	b) Automatic Vacuum relief valve	To be Provided on suction pipeline on board dredger.
	c) Non return Valve	To be Provided on discharge pipeline on board dredger.
	d) Fuel & running hour meter	Fuel & running hour meter to be provided.
	e) Dredging depth meter	Electric ladder angel transmitter, presentation via HMI in operating cabin.
	f) Lights	In addition to normal lights for operation of the dredger, for night time operation sufficient halogen lights are to be provided in suitable locations.
	g) Portable bilge pump (diesel engine or electric motor driven)	To be operated when dredger is not in operation. In built bilge pump to be provided
	h) Portable welding set with diesel engine	400 Amps output with all accessories- 1 set for each dredger.

i) Electric bench grinding machine	Electric motor driven bench grinding machine of disc size 200 mm (min) to be provided.
j) Electric bench drill machine	Electric motor driven bench drill machine of drill size 12 mm (min) to be provided.
k) Fuel oil transfer pump	Electric motor driven pump to be provided.
l) Mechanical ventilation for the engine room and auxiliary equipment room	Air Blowers and Exhaust fans are to be provided of adequate capacity and number for proper ventilation considering high temperature and humidity in Bangladesh.
m) Tanks	Fuel oil tanks, dirty oil tank, dirty water tank, faeces tank, water ballast tanks, fresh water tank, dry tanks and store with storing facilities are to be provided.
n) Signal mast	To be Provided with requisite signal lamps, search lights etc. Complete for navigation.
o) Bollard	8 Nos. double bollard shall be provided on the side pontoon of dredger.
p) Communication equipment	1 No. GPS Receiver, 1 No. VHF/UHF, shall be provided. All communication equipment shall be 2019 model or latest. All communication equipment shall be of class type approved. Country of Origin: EU Countries/UK/ USA/ Australia/ Canada/ Japan
q) SSB Set	SSB set to be provided for each dredger for communication. All navigational equipment shall be of class type approved. Country of Origin: EU Countries/UK/ USA/ Australia/ Canada/ Japan
r) Furniture	Adequate furniture for all spaces to be provided.
s) Gland pump for dredge pump	Gland pump having capacity minimum 30 cubic meter to be provided.
t) Flushing pump for cutter bearing	Flushing pump having capacity minimum 40 cubic meter to be provided.
u) Switchboard	The main switchboard & emergency switchboard shall be class approved and certified.
v) Distribution Systems, Electric Cable & lights	Others power distribution boards & Group starter panels shall be class certified. All the electrical cable should be marine quality type & shall be class type approved. Circuit breakers shall be class type approved. All navigation lights shall class type approved.

1.26	Other Supplies	<p>To be supplied:</p> <p>(a) For each dredger</p> <ul style="list-style-type: none"> i. Lifesaving appliances, i.e., Life jackets, life buoys etc. of adequate number as per class requirement. Life Saving appliances shall be provided as per approved Safety plan by classification society. All LSA items shall be class type approved. All the life savings appliances should be subjected to classification society requirement and approval or as per IACS 99. The following lifesaving and signal appliances will be supplied, ii. Boatswain's inventory, iii. Firefighting appliances- Firefighting appliances shall be provided as per approved Fire safety plan by classification society. All FFA items shall be class type approved iv. First Aid box. v. Tools as described in sl no. 1.19.1 for general maintenance and special tools for dredge pump, cutter, hydraulic system, electric system, engine and other works to be provided. vi. Instruction Manuals and Operation & Maintenance Manuals for dredgers, dredge pump, cutter, hydraulic & electric system, engines, generator, crane and all accessories fitted on board dredger in English language-3 sets. vii. Spare parts Catalogue/Books for all components in English language-3 sets. viii. Drawing—General Arrangement (GA) and other relevant drawings-3 sets in English language. ix. Submersible Pump having dia. 3" shall be provided. x. 2 nos. desktop Computer (latest model) & 2 Nos. Laptop (latest model) with printer & UPS shall be supplied. Computers and Laptops shall be configured with the Genuine Windows 10 along with Anti-Virus (Kaspersky). All laptop and pc will have to be supplied with Microsoft Home Office 365 license for minimum 2 years. xi. 1 No. Photocopier (latest model of Toshiba/Equivalent) shall be supplied. xii. 2 pairs walk talky (10 km range) to be supplied. xiii. Hand Mike (1 km range) to be supplied. xiv. 1 No. Smart Cell-Phone (iPhone) of latest model is to be supplied. xv. As built drawing (Hard & Soft copy) for each dredger shall be provided during delivery- 3 sets. xvi. 1 No. LED Colour TV (48") (latest model of Sony/Samsung) shall be supplied. <p>(b) For whole package</p> <ul style="list-style-type: none"> i. 1 no. HDPE floating pipe and foam type floater repairable machine shall be supplied. Country of origin: EU Countries/ USA/ Australia/ New Zealand/ Canada/ Japan/UK ii. 2 Nos. extra spud shall be supplied. iii. A prototype model for 28-inch cutter suction dredger is to be provided having length approximately 0.75m. iv. 1 No. Multimedia Projector with screen (latest model of LG/BenQ) shall be supplied.
------	----------------	--

1.27	FS Wire Rope	For Side Winch: 4 Coils per dredger Size: minimum 36 mm For Ladder: 2 Coils per dredger Size: minimum 36 mm For dredger Towing: 2 Coils per dredger Size: minimum 28 mm Specification: Construction of the Rope: 6 X 19 (12+6+1) FC Normal Tensile Strength: 1670-1770 N/sq.mm Lay of Wire: Right Hand Regular Lay Minimum Breaking Strength for 28 mm: 432-458 kN Minimum Breaking Strength for 36 mm: 714-757 kN Length per coil: 300 meters Grade: A (Galvanized)
------	---------------------	---

1.28 Each dredger shall be equipped with following online monitoring system:

A. General Specification:

The system should have RTK (Real Time Kinematic) heading GNSS (Global Navigation Satellite System) with beacon tracking capability; inclinometers/angle sensors and on-board software which should be able to work with a RTK GNSS base station both using radio as well as cellular RTK communication. This system should be able to work with a predefined design surface providing guidance to dredger operator for accurate dredging and should be able to update and store the as-built dredging surface in real time during operation. It should provide requisite software in office to view remote dredger in real time - the views and data will be similar to what the dredge operator is viewing, that is position of dredger and cutter depth relative to the bathymetry survey and the design surface. All parts (sensors, GNSS & software) shall be supplied preferably from one manufacturer. Tenderer shall submit manufacturer Authorization Letter for online monitoring system. This online monitoring system will be installed in the dredgers which are subjected to continuous dredging operation with a dredging depth upto 20 metres. Therefore, the tenderer have to submit their offer with consideration of the above matter. Details Specification has given below:

Sl no	Item	Quantity (unit)	Characteristics	Specification
i	GNSS Rover	1 no.	Satellite Tracking Measuring Modes Number of Channels	Should be Capable of tracking, GPS, GLONASS, GALILEO, BeiDou DGNSS Corrections via MSK Beacon Reception , 2 Channel SBAS (WAAS/EGNOS/MSAS/GAGAN) Real-time Kinematic 400 or more

			Real Time Accuracy for Kinematic	
			Horizontal	8 mm + 1 ppm or Better
			Vertical	15 mm + 1 ppm or Better
			Code Differential Accuracy	25 cm + 1 ppm or Better
			GNSS Antenna	2 nos separate antenna with each GNSS Rover for heading. Should be able to work with MSK Beacon. To be supplied with 10 meter antenna cables.
			Memory	6GB Internal memory, Should have expandable facilities through memory stick
			Communication	Should have 3 serial ports or more Mini USB, Ethernet port, pps output or Better Should have inbuilt Wi-Fi, Bluetooth, Radio, cellular in a single housing as GNSS Receiver.
			Physical and Environmental Specification	
			Operating Temperature of GNSS Receiver	-40°C to +65°C or Better
			Storage Temperature of GNSS Receiver	-40°C to +95°C or Better
			Shock	MIL-STD 810F or Better
			Position Update Rate	20 Hz or Better
			Water and Dust	IP67 water proof, Should be Dust proof or Better
			NMEA output	Support for NMEA output.
			RTK Corrections data format input/output	At least RTCM 2.x, 3.x, 3.1 input & output, CMR+ CMRx
			Power	
			Internal	Removable Internal battery for minimum 6 hours rover operation
			External Power	9-36 V DC external power input. Should have Overvoltage protection
			System	
			On-board keyboard and display	OLED display with 4 arrow keys (up, down, left, right) and OK key or Better
ii		1 set (Each	Dual Axis Angle Sensors	

	Dual Axis Angle Sensors	set consists of 2 nos.)	Sensor Enclosure	E-Coated aluminum 6061 equivalent alloy. Stainless Steel backing or Better
			Connection Port	Minimum 2 x Deutsch DT series 4-pin male compatible
			Signal Output	CAN bus J1939. Pin 1: GND, PIN 2: V+, Pin 3: CAN Low, Pin 4: Can High or more
			Range	+/- 180° pitch, +/- 75° roll, +/- 2 G acceleration, +/- 200°/s rate of rotation
			Output Rate	1, 25, 50, 250 Hz configurable
			Low dynamic tilt accuracy	+/- 0.1° Less than 1.5 meters per second or equivalent.
			High dynamic tilt accuracy	+/- 0.5°
			Dynamic Accuracy Limit	300°/s or Better
			Operating Vibration Limit	5 G peak or Better
			Supply Voltage	9 ~ 30 V DC
			Power Supply Protection	Any polarity up to 36 V
			Environment Protection	IP67 or Better
iii	Rugged Computer to Run On-dredge Marine Software	01 No	Rugged Computer	Rugged vehicle type computer running windows 10 & UPS with a separate screen with OEM specified specification to run on-dredge Marine Software with power cable carrying bag and other related accessories
iv	On Dredge Software	01 No	<p>The software should support visualization and monitoring of the angle and position of the ladder and cutter head.</p> <p>It also should show the absolute position of the dredge head in relation to the surveyed and any number of design surfaces.</p> <p>The working surface should be updated with the dredged depths in real time and displayed in plan, profile and 3D views.</p> <p>Over-dredge and under-dredge tolerances can be set and are visible on the profile view of the dredge head.</p> <p>The software should support customizable interface: Multiple monitors, with independent layouts can be tailored to the needs of the dredge operator. A color-coded plan view and 3D rendering highlights high and low spots.</p>	

			<p>The surface Digital Terrain Model (DTM) is updated in real time registering the progress of the dredging work showing depth, differential and production models all updated according to progress of the cutter head.</p> <p>Should support Continuous data logging for as build and volume reports.</p> <p>Should support Dredge tolerance visualization provides guidance for accurate, efficient dredging productivity.</p> <p>Should be configurable by Administrator who can configure the screens for a specific workflow/user and lock it down for the operator, this helping to work on a preconfigured manner without any obstacle.</p> <p>Import or build project design and survey models in the office or field.</p> <p>Should Supports RTK for precise tide and heave calculation.</p>	
v	GNSS Base	01 No	Measurements Specification	
			Satellite Tracking	Should be Capable of tracking, GPS, GLONASS, GALILEO, BeiDou or more
			Measuring Modes	Real-time Kinematic
			Number of Channels	400 or more
			Real Time Kinematic Accuracy	
			Horizontal	8 mm + 1 ppm or Better
			Vertical	15 mm + 1 ppm Better
			Code Differential GPS Positioning	
			Horizontal	25 cm + 1 ppm or better
			Vertical	50 cm + 1 ppm or better
			GNSS Antenna	Modular receiver and antenna
			Others	Tripod, Tribach with optical plummet and Tribach Adaptor for Base GNSS- 01 Set to be supplied.
			Communication	Minimum 2 External Power ports (Power ports should not be connected internally), 1 Serial Port, 1 lemo port, Bluetooth, Ethernet. Base Station should be configurable using Ethernet port
				External 35watt UHF radio for RTK Base.
			Physical and Environmental Specification	

			Operating Temperature for GNSS	-40°C to +65°C or Better
			Storage Temperature for GNSS	-40°C to +75°C or Better
			Position Update Rate	upto 20 Hz
			Water/Dust	IP67 1m water immersible/ Should be Dust proof or Better
			Power	
			Internal Battery	at least 10 Hours
			External Power	Cable to connect the system to a 12v battery should be supplied.

b. Software Supply: For 02 Dredgers.

i.	Remote Monitoring Software in Office providing real time field information to office when field dredgers are connected to office through Internet using cellular or some other communication	01 No.	Should be able to view a remote dredger operation in real-time The views and data will be similar to what the dredge operator is viewing i.e. position of dredger and cutter depth relative to the bathymetry survey and the design surface. The office software can view individual dredgers as required. Tracking of each Dredgers productivity from Office computer																						
ii	Computer	01 No	For monitoring purpose 1 (one) Computer shall be supplied by the supplier. The minimum specifications of the computers are as follows: <table border="1" style="width: 100%; border-collapse: collapse;"> <thead> <tr> <th colspan="2" style="text-align: center;">Minimum Specifications</th> </tr> </thead> <tbody> <tr> <td>Operating System</td> <td>Windows 10 Professional Version (Genuine)</td> </tr> <tr> <td>RAM</td> <td>8GB</td> </tr> <tr> <td>Hard Drive (GB)</td> <td>512 GB SSD</td> </tr> <tr> <td>Processor (CPU)</td> <td>64-bit processor with 4 parallel threads, Intel 5th Gen i7 or better</td> </tr> <tr> <td>Display</td> <td>Recommended: 1920×1080, Minimum: 1366×768</td> </tr> <tr> <td>Graphic Card</td> <td>DirectX Graphics Card, More than 1 GB graphics memory</td> </tr> <tr> <td>Power</td> <td>9-32 V DC input range</td> </tr> <tr> <td>USB Ports</td> <td>4</td> </tr> <tr> <td>Serial</td> <td>1 × DB9 (RS232)</td> </tr> <tr> <td>Ethernet</td> <td>1 × RJ45</td> </tr> </tbody> </table>	Minimum Specifications		Operating System	Windows 10 Professional Version (Genuine)	RAM	8GB	Hard Drive (GB)	512 GB SSD	Processor (CPU)	64-bit processor with 4 parallel threads, Intel 5th Gen i7 or better	Display	Recommended: 1920×1080, Minimum: 1366×768	Graphic Card	DirectX Graphics Card, More than 1 GB graphics memory	Power	9-32 V DC input range	USB Ports	4	Serial	1 × DB9 (RS232)	Ethernet	1 × RJ45
Minimum Specifications																									
Operating System	Windows 10 Professional Version (Genuine)																								
RAM	8GB																								
Hard Drive (GB)	512 GB SSD																								
Processor (CPU)	64-bit processor with 4 parallel threads, Intel 5th Gen i7 or better																								
Display	Recommended: 1920×1080, Minimum: 1366×768																								
Graphic Card	DirectX Graphics Card, More than 1 GB graphics memory																								
Power	9-32 V DC input range																								
USB Ports	4																								
Serial	1 × DB9 (RS232)																								
Ethernet	1 × RJ45																								

			CAN Bus	1 × DB9(M), Compatible with IXXAT (eg. CAN-IB120/PCIe Mini)
			Mounting Bracket	VESA 100 mm × 100 mm
			Shock	10G Peak Acceleration (11 msec duration)
<p>All Computers including Rugged Computers shall be configured with the Genuine Windows 10 along with Anti-Virus (Kaspersky).</p>				

Country of origin for online monitoring system- USA/CANADA/JAPAN/EU Countries/Australia/ UK/ New Zealand/Mexico

c. Complete Local Training on GNSS RTK based Real Time Dredge Monitoring Solution for Cutter Suction Dredgers is to be arranged for 10 (ten) BIWTA engineers for 10 (ten) days and 3 (Three) days training every 3 (Three) months up to (01) one year by the supplier's own cost through Original Equipment Manufacturer. Accommodation, food, transport and all other allowances for the trainers to be borne by the supplier.

1.29 Tools for general maintenance and special tools for all engines, sand pump, cutter, hydraulic system, electric system and other works to be provided.

1.29.1 Engine Room Outfit and General Tools for each dredger:

- 1 - Micrometer, 25 - 50 mm
- 1 - Surface gauge, 290 mm height.
- 1 - Straight edge, 600 mm
- 2 - Inside calipers, 300 & 200 mm
- 2 - Outside calipers, 300 and 200 mm
- 2 - Compass 300 & 200 mm
- 2 - Thermometers 100 C, with casing
- 2 - Straight shank drills 3 & 5 mm
- 1 - set Taps W3/8 - W1
- 1 - Plier, 200 mm
- 6 - Files 250 mm, Coarse and medium, flat, round and half round.
- 3 - Files 200mm, Fine, flat round and half round.
- 1 - set Files, fine
- 3 - File shanks
- 2 - File brushes
- 2 - Hammers, 2 lbs and 1 lb.
- 1 - Wooden hammer
- 1 - Hammer 10 lbs
- 1 - Scrapers, flat and cent
- 1 - Punching centre
- 4 - Punches, 11, 14, 18 & 21 mm
- 4 - Cold chisels 200 & 150 mm, flat & cross-cut
- 2 - Oil groove chisels, 150 x 22 x 5 mm x 130 x 19 x 3 mm
- 1 - Packing knife

- 1 - set Hacksaw frame with 12 blades
- 1 - Vice, 150 mm
- 1 - Oil stone, 150 x 50 x 25 mm
- 4 - Electric torches
- 1 - Chain block, 1 ton
- 1 - Rubber hose for air, complete with coupling, 6mm dia x 10m
- 1 - Copper hammer, 1.35 kg
- 1 - Lead hammer, 1.8 kg
- 1 - Tool box, steel
- 1 - Clock, 2-hand
- 1 - Turning bar/rotating tool for main engine
- 16 (from 3/8 to 1^{1/2})-Double end open spanner
- 16 (from 3/8 to 1^{1/2})-Double end ring spanner
- 24- Socket box wrench
- 4 (300 lb, 500, 700, 1000 lb)-Torque wrench 3/4 drive
- 1-Ring & Dull wrench
- 1-Resset
- 1-Temperature Gun
- 1-Filler Guage
- 1-Sliding wrench
- 1- Slide Calliper
- 1-Techometer

All tools must be EU countries/Australia/USA/Canada/Japan/UK origin.

A-2: AUXILIARIES AND SERVICES FOR DREDGER

1. **Production Measuring System**
Complete set of production measuring system with velocity and density measuring instruments and production presentation on dredgers HMI for measuring solid output of dredged material in tons and cubic meters per hour. Radio frequency shall be used for measuring production. Cumulative production is also to be recorded. All instruments, computers etc. needed for the system are to be supplied in complete set.
2. **Dredged Track Presentation System (DTPS)**
Dredge Track Presentation System is to graphically display presentation system top view of the dredger and surrounding bottom profile, required for (DTPS) positioning purposes with all accessories complete. Instruction Manual and Spare Parts catalogue in English Language-3 sets.
3. **Training in Bangladesh**
On job training is to be arranged for Engineers & Operators (dredger operation crew, engine room crew and repair & maintenance crew) on all equipment of dredger.
The training period should be at least 7 (seven) days for 10 (ten) persons. The training is to be held repeatedly throughout the warranty period.
Accommodation, food, transport and all allowances to be arranged by the supplier for the trainees.
5. **Cost of operation**
During test-trail, cost of operation including diesel fuel, lubricating oil, gear oil, connection of floating pipe (min 2500 m), floater, ball socket, rubber hose pipe etc. shall be supplied. All cost shall be borne by the supplier. The test trail shall be done for minimum 50 Hours.

Operation contract for dredgers

Requirement:
Very high skilled operation crew for operation of the dredgers.

Operation period:

12 (twelve) months in a year (January to December).

Working period-12 hours x 6 days per week.

Number of Person with Skill Level:

- 1) **4 Nos. Dredger Master/Leverman** of very high skill level is to be engaged. The average production output of dredger achieved should be at least 90% of the rated capacity. This may be calculated on weekly basis. Should be capable of planning the dredging operator independently as per project requirement in consultation with the project engineers. Should be able to communicate in English.
- 2) 2 nos. **PLC Expert Engineer** of very high skill level experienced in supplied model of dredger is to be engaged. Should be able to Communicate in English. To be fully capable of operating all instruments fitted in the dredger.
- 3) 2 nos. **Driver & 4 engine crews** shall be provided for two dredgers.

Cost of travel and accommodation etc:

All expenses for operation contract including travel, food, boarding, etc. shall be borne by the supplier.

Supporting Crew:

Other Supporting Crew for dredger will be provided by the employer.

Cost of operation:

Cost of fuel, lub oil etc. will be arranged by the BIWTA.

6. Foreign Training is to be arranged for 5 (five) BIWTA engineers on maintenance, operation, Electronic technicians (ET) Software/Trouble Shooting Software/PLC system. Air ticket, accommodation, food, transport and all allowances to be arranged by the supplier for the trainees. The training period should be at least 07 (seven) days excluding traveling & transit at manufacturer country.

7. Local Training of dredger including on board dredger is to be arranged for 10 (ten) BIWTA engineers on maintenance, operation, Electronic technicians (ET) Software/Trouble Shooting Software/PLC system. Accommodation, food, transport and all allowances to be arranged by the supplier for the trainees. The training period should be at least 10 (ten) days excluding traveling.

8. IF PLC (programmable logic circuit) or other computer controlled system is used in engines or any component then manufacturer wise Electronic Technicians (ET) Software (Customer version in English language)/Trouble Shooting Software/Diagnostic Tools, computer, cables with accessories is to be supplied. The software shall be updated regularly as & when necessary up to 10 years. Necessary training is to be arranged.

*

9. The supplier must notify to the classification society before opening of Letter of credit (LC) for procurement of those items/equipment which are needed classification society approval/certification.

B. CRANE BOATS for 28" Dredgers

B-1. GENERAL PARTICULARS

1.0 Main characteristics

The vessel shall be provided with heavy steel fendering all around, Flush type Engine Room removal hatch, heavy deck crane support foundation, towing bit, Propeller Nozzle (to create extra thrust), etc.

The appropriate class notations for fully classed hull and machinery to be mentioned in the offer.

Full Class Notation (Hull):

Means ship's hull design, hull materials used and constructions done under the proposed Classification society Special Survey in full compliance with the Rules and regulations. Hull notation shall be mentioned at the technical specification, Example- \times 100A1 or Equivalent.

Full Class Notation (Machinery):

Means all propelling and essential auxiliary machinery to be designed, constructed, installed and tested under Special Survey in accordance with proposed Classification society Rules and Regulations.

Propelling and essential auxiliary machinery includes machinery, equipment and systems installed for the ship to be under seagoing conditions and that are necessary for the following:

- a. Maintaining the watertight and weathertight integrity of the hull and spaces within the hull.
- b. The safety of the ship, machinery and personnel on board.
- c. The functioning and dependability of propulsion, steering and electrical systems.
- d. The operation and functioning of control engineering systems for the monitoring and safety of propulsion and steering systems.
- e. The operation and functioning of emergency machinery and equipment.

Machinery notation shall be mentioned at technical specification, Example- \times LMC or Equivalent.

The cost of the Classification society shall be borne by Purchaser through Supplier and the Classification society will be fully responsible to the Purchaser for their work. Details responsibility of the Classification society has been attached in **Annex-II**. Price for this work shall be quoted in the price schedule for related services (**Form PG4-3D**). The total contract price shall be inclusive of the price of classification society.

The Hull of the vessel including its machinery shall be built and classed under the rules and regulations of the International Classification Society of Lloyds/ABS/NKK/DNV.GL. The appropriate class notations for fully classed hull and machinery to be mentioned in the offer. The Classification society will be fully responsible to the Purchaser for their services rendered. The other rules and regulations applicable for construction of this vessel including IMO stability guideline covering weather criteria shall be followed.

1.01	Principal dimension	
	Length O.A (about)	20.00 m
	Breadth (about)	8.00 m
	Depth (about)	2.50 m
	Draught loaded (maximum)	1.20 m
1.02	Propelling Machinery	
	Number of engines	2 No. (Twin screw)

	Make	Marine Engine of reputed make which shall be type approved by appointed classification society.
	Country of Origin, Country of Manufacture, Country of Assembly, Country of Shipment	EU Countries/USA/Australia/Canada/Japan/UK
	Power	Required to achieve the speed of 7.50 knots
	RPM	Not exceeding 1800
	Speed (Full loaded condition)	7.50 Knots
1.03	Performance	
	Deck Crane capacity	Foldable (two folds) knuckle boom telescopic Crane to be installed on fore deck. Lifting capacity shall be minimum 10 tons at 8m outreach & boom length should be adequate to work with the dredgers.
	Slewing angle	360°
	Country of Origin (Crane)	EU Countries/ USA/Australia/Canada/Japan/UK

1.04 General Arrangement

The vessel will be a twin-screw diesel propelled, steel, crane boat of flush-deck type having a transom stern and a complete continuous deck below which the space will be subdivided by four transverse watertight bulkheads into four compartments.

- (1) Fore peak;
- (2) Boatswain's Store;
- (3) Space between Boatswain's Store and Engine Room
- (4) Engine room.
- (5) Aft peak & steering gear compartment

1.05 Materials & Workmanship

The Builder will supply all materials, equipment and machinery required for completion of the vessel. All these materials and equipment supplied will be new and of latest design and intended for marine use and also in accordance with the rules and regulations mentioned above and also other requirements of the governing bodies concerned.

Steel materials used for the vessel will be open-hearth or electric furnace processed mild steel of a good and uniform quality certified by the Classification Society for compliance with its rules.

All workmanship inspect of the construction of the vessel will be in accordance with the normal shipbuilding practice for this kind of vessels.

1.06 Plans and Instruction Books

Prior to the execution of the work concerned, 2 (two) copies of each of the following plans and booklets shall be submitted to the Purchaser for their approval. 3D general Arrangement shall be provided to the owner before starting of construction. Such approval of the Purchaser shall not relieve the supplier of his obligations under this contract.

- i) Specifications
- ii) General arrangement
- iii) Lines & offsets
- iv) Hydrostatic curves
- v) Capacity plan (preliminary)

- vi) Stability booklet
- vii) Midship section
- viii) Construction profile & deck plan
- ix) Shell expansion
- x) Rudder & rudder carrier
- xi) Hull construction plans
- xii) Steering gear arrangement
- xiii) Scheme of painting
- xiv) Engine room arrangement
- xv) Main engine specification & assembly
- xvi) Auxiliary engine specification & assembly
- xvii) Hydraulic crane specification and assembly plan
- xviii) Load diagram of hydraulic crane
- xix) Range diagram of hydraulic crane
- xx) Load and Range diagram of crane
- xxi) Hydraulic pumps, specification and assembly plan
- xxii) Diagram of standard slewing arc
- xxiii) Diagram of cooling water pipe systems in engine room
- xxiv) Diagram of bilge, ballast and water service pipe systems in engine room
- xxv) Diagram of lubricating oil pipe system in engine room
- xxvi) Diagram of fuel oil pipe system in engine room
- xxvii) Diagram of main electric feeder circuits
- xxviii) Diagram of electric lighting, navigation aids etc., feeder circuits
- xxix) Main switchboard assembly plan & connecting diagram

2 (two) copies of each of the following plans and booklets shall be submitted to the Purchaser for their approval upon completion of vessel and before test& trial.

- i) List of deck inventory
- ii) List of spares, tools and outfit of machinery part
- iii) List of spares and accessories of electric part
- iv) Schedule of inclining test
- v) Schedule of official sea trials
- vi) Schedule of various test and trials to be attested by Purchaser.

Upon the delivery of the vessel, the following finished plans shall be prepared and delivered to the purchaser.

The number of copies shall be three (3) for plans and two (2) for booklets.

All relevant as fitted and as built drawings and booklets from the above list will also be supplied.

Capacity plan with tanks & deadweight scales
 Final calculation for weight, trim and stability
 Stability curves
 Results of inclining test
 Results of official sea trials
 Results of various tests and trials for machinery part
 Results of various tests & trials for electric part
 Docking plan

One set of the following finished plans shall be mounted on frames and displayed onboard:

General arrangement
 Arrangement of safety equipment

Three (3) copies of suitable instruction books written in English shall associate the following machinery and equipment:

Steering gear
Main engine
Generators
Navigation equipment
Crane

As built drawing (Hard & Soft copy) for each crane boat shall be provided during delivery- 3 sets.

1.07 Tests & Trials

Crane, Main Engine, Generators, switch board, electric motors and control gears and other machinery, equipment and systems shall be tested under the working conditions.

Insulation tests shall be made for all electric equipment and systems after installation onboard.

Results of these tests and trials shall be submitted to the Purchaser immediately after completion.

1.08 Registration & Survey must be completed by suppliers' own cost.

B-2. HULL

2.01 Steel Work in General

Steel for hull fabrication including superstructures shall be class certified under which class vessel shall be built.

The hull including superstructures will be constructed of steel throughout on the longitudinal system of framing. Good continuity of structural members in the basic hull structure will be maintained, and where members are discontinuous, continuity will be provided with by means of suitable tapers, overlaps, doubler plates and/or brackets. Bulb profiles (HP) should be used as the stiffeners of the Crane Boat. All the bulb profile and steel plates must be certified by the classification society which is member of the IACS. Necessary documents/certificates must be provided to the purchaser for the evidence that all the MS plates and bulb profiles are certified by above mentioned class. The supplier must notify to the purchaser after opening of letter of credit (LC) for procurement of MS plate and Bulb profile.

The workmanship will be such as to ensure reasonable fair lines and smooth surfaces, attention will be given to the neatness of structural connections. Cuts in structures for engineering systems such as ventilating ducts, piping systems and electrical cables will be made according to standard shipbuilding practice, and portions unduly weakened by cutting such holes will be suitably compensated.

2.02 Hull Scantlings:

The hull hunting scantlings shall be as per the rules of classification society. A guideline (not restrictive) scantlings may be as follows:

- Sides, ends, bottom and deck plating	10 mm
- Bulkheads	6 mm
- Longitudinal frames, Bulb profiles (spacing 500 mm)	75 x 9mm
- Web frames sections (spacing 1000mm & 1500mm)	200 x125 x 8mm
- Stiffeners on bulkheads (Bulb profiles)	75 x 6mm
- Steel fender all round at deck level Consisting of a half-rounded pipe	150 mm (dia) 8mm (thickness)

2.03 Welding

Electric arc welding will be applied to all connections of structural members. Portions of members where welding is to be applied will be well prepared prior to welding work in order to obtain good results. Qualified welders with coated electrodes and automatic welding by "Union melt" or equivalent process will execute manual welding. The materials and the procedure of welding will comply with the requirements of the Classification Society regarding welding. All welding consumables shall be particular class type approved under which ship will be built and from a reputed and well known source.

2.04 Keel

The Keel will be of flat plate type and properly shaped and secured.

2.05 Steel Skeg

The end of propeller shafts will be supported by a skeg of steel construction. The boss will be of cast steel. The rubber bearing lined bronze or equivalent materials bush will be used in the boss.

2.06 Rudder

The vessel will have one rudder of single plate semi-balanced type, connected to the rudderstock by a flange coupling. Rudder shall be manufactured and certified by the particular class.

2.07 Bottom Construction

The bottom will be of single bottom type constructed.

Under the main engines, strong continuous engine girders with strong top plates will be provided. The engine room webs will be 500mm apart following the class rules and will terminate on the engine girder. Inside of the engine, brackets will support girder. In the forward region, the bottom will be reinforced as required by the rules.

2.08 Web Frames and Side Stringers

Web frames will be fitted at a space of 1000 mm and 1500 mm apart following the class rules and welded to the shell plating. A side stringer will be provided on each side in way of the forward hull and the engine room.

2.09 Bulkheads

Main watertight transverse bulkheads will be arranged as shown on the general arrangement plan and extended up to the main deck. These bulkheads will be of welded flat type reinforced with vertical stiffeners bracketed at top and bottom as far as practicable. All bulkheads will be tested as required by the rules.

2.10 Shell Plating

All butts and seams of the shell plating will be welded. The shell plating in way of large openings will be properly compensated with doubler plates or by increasing plate thickness.

2.11 Main Deck

The main deck will be constructed with steel plates. Thicker plates or doubler plates will be laid at corners of large openings where considered necessary.

The deck stringer plates will be directly welded to the sheer strakes. Beams will be fitted transversely at every web frame & welded to the deck plating. Under-deck girders will be provided to support and stiffen the deck.

The deck will be well reinforced in way of deck machinery, deck crane & other heavy articles.

2.12 Machinery Foundation

Foundations under machinery will be of welded construction well connected to the bottom structure, and strong enough to stand up to the loads and vibrating forces of the machinery installed thereon. The top plates, webs and brackets will be of sufficient thickness. The main engine foundation will consist of continuous engine girders with strong top plates, constructed as an integral part of the bottom structure. Care will be taken to keep efficient continuity of strength at their ends. Foundations of the generating units, engine room auxiliaries, deck machinery, crane, etc., will be constructed on structures, which are to be suitably reinforced.

2.13 Wheelhouse

Wheelhouse will be constructed of steel plate. Sidewalls will be reinforced with vertical stiffeners and the roof will have transverse beams as necessary. Girders will be provided as necessary.

2.14 Tanks

Tanks will be arranged as shown on the general arrangement plan and constructed integral with the hull structure. Necessary pipelines, i.e. filling, suction, sounding and air escape pipes and also access manholes will be provided for these tanks.

2.15 Hull Fittings

2.15.1 Mast

A steel mast will be erected on the wheelhouse top to carry mast lamp brackets and a halyard for hoisting flags and spreading antennas. The mast will be collapsible.

On the wheelhouse top two steel board light boxes will be placed for the P.S. and S.B. lights.

2.15.2 Mooring & Anchoring

Double bollards of size 168 mm dia x 8 mm thick following the class rules will be arranged on the fore and aft, at port side and starboard side on the main deck. The Mooring & Anchoring gear shall be subjected to class approval.

2.15.3 Hoisting eyes (for Purchaser's use)

For hoisting, the vessel will be provided with 4 (four) hoisting eyes through the deck to the web frame construction.

2.15.4 Steering Gear

One set of manual hydraulic steering gear, suitable for single-rudder arrangement will be installed at ship's aft. The steering gear will be energized by manual hydraulic cylinder connected to the steering wheel in the wheelhouse. The steering gear will be capable of moving the rudder from 35 degrees on one side to 35 degrees on another side within about 28 seconds. Emergency steering arrangement will be provided. The steering gear system shall be subjected to classification society approval.

2.15.5 Fender

Steel fender consisting of a half round pipe of 150 mm diameter and 8 mm thickness will be provided all around at deck level of the vessel. Country of origin of the fenders shall be mentioned by the tenderer.

2.15.6 Stairways, Ladders and Steps

All stairways will be of steel. These stairways will have non-skid treads and galvanized tubular steel handrails. Steel vertical ladders will be fitted for access to the wheelhouse top, etc. The minimum width of the stairways on the exposed decks should be subjected to classification society requirements.

2.15.7 Hatches and Manholes

On the main deck and above the engine room, one large watertight hatch will be fitted for engine removal. The engine room entrance to be situated against the wheelhouse and will be provided with a watertight hatch on a raised coaming. For the store and the forepeak, watertight hatch will be provided. Oval manholes will be provided for access to tanks. Bolted flush steel covers will close these manholes.

Hatch covers and other manhole covers shall be designed as per classification rules and duly approved by the class and certified as applicable. Hatches and manholes shall be designed as per classification rules and approved by the class and certified as applicable.

2.15.8 Doors & Windows

The wheelhouse will have hinged aluminum alloy water tight door. All watertight doors & windows should be marine quality, class approved and class certified.

2.15.9 Natural lighting and Ventilation

One ventilation cowl will be provided for adequate natural ventilation of the engine room. Light alloy framed windows of fixed and hinged up type will be fitted on walls of the wheelhouse. Extruded aluminum glassed with 6mm thick glass fitted with long bolts and phenol resin washer will be provided.

A 250-mm dia clear view screen will be provided.

2.15.10 Sound Signal

On the wheelhouse top an air whistle will be fitted, fed by an air compressor fitted in the steering wheel casing.

2.15.11 Life Saving Appliances

The following lifesaving and signal appliances will be supplied and to be in accordance with rules and regulations applicable:

Buoyant apparatus	1 No.
Life buoy, solid	2 Nos.
Life jacket	2Nos.
Self-activating water light	1 No.
Self-activating smoke signal	1 Nos.

All lifesaving appliances should be subjected to classification society requirements and approval or as per IACS 99. Life saving appliances shall be provided as per approved safety plan by classification society.

2.15.12 Fire Fighting Systems and Appliances

Firefighting appliances shall be provided as per approved fire safety plan by classification society. All FFA items shall be class type approved.

A deck wash connection and fire main pipeline will be installed along one side of the main deck. This line will be fed with river water by the general service pump and the bilge and ballast pump. Hydrants will be suitably arranged on the fire main line so that any part of the vessel can be reached by a powerful water-jet. Canvas fire hoses of 1.5" bore and 18 meters in length, complete with nozzle, will be supplied and stowed in red paint cases. Portable fire extinguishers will be supplied as specified elsewhere as per the requirement of the rules and regulations.

2.15.13 Cathodic Protection

The vessel will be equipped with a cathodic hull protection system for the underwater parts of the hull with sufficient zinc anodes of 3 kg. and 1.50 kg.

2.15.14 Markings

The ship's name in both English and Bengali letters and the draft marks in Arabic numerical in metric scale will be cut from steel plate and welded on the shell, and painted as directed by the purchaser. Draft marks will be fitted at the bow, stern and amidships in metric scale. The load-line marking should be subjected to class approval as applicable.

2.16 Wheelhouse Furnishing Schedule

2.16.1 Wheelhouse

- 1 - Fan
- 1 - Compass table
- 1 - Steering pedestal
- 1 - Foot grating
- 1 - Flag rack
- 1 - Magnetic compass
- 1 - Binocular
- 1 - Nav. lamp indicator

- 1 - Voice tube
- 1 - Thermometer
- 1 - Clear view screen,
- 1 - Engine remote control console
- 1 - High chair
- 1-Hand Mike.

All the windows except middle windows in the wheel house must be easily openable Arrangement shall be provided to permit rapid shut down and effective closer in case of weather and sea condition. In wheel house, fuel & running hour meter to be provided.

2.16.2 Boatswain's Store

The space under the main deck between the forepeak and engine room shall be used as a boatswain's store.

The shell sides shall be sparred with wooden battens up to a suitable height and the floor laid with wooden gratings. Wooden shelves shall be fitted along the shell sides.

2.16.3 Navigational Panel/ Console

All the wooden works of bridge deck including navigational panel should be of foreign made marine quality plywood/wood.

Country of origin of plywood/wood- To be mentioned.

Navigation light panels shall be class certified. Navigation lights shall be of class type approved.

2.17 Deck Piping

2.17.1 Piping in General

Pipes, valves, cocks, flange, etc., will be of such qualities and dimensions as to comply with rules of the Classification Society and as per approved drawing. Pipes will be efficiently supported or embraced to stand up to vibrations. Care will be taken where pipes are concealed by room furniture so that reasonable access may be provided for overhauling. Where pipes pass through watertight bulkheads or decks, bulkhead or deck pieces will be fitted. Where the danger of mechanical damage is expected, pipes will be well protected by means of wooden or steel covering or guards. All the valves shall be subjected to classification society requirement & approval.

2.17.2 Pipe Materials

Pipes will generally be steel pipes of such qualities and dimensions as to comply with the requirements of classification society. Galvanized pipes and flanges will be used for piping not coming into contact with oil.

2.17.3 Wash deck and Fire Main Piping

The wash deck and fire main pipeline will be installed along one side on the main deck. The pipeline will be supplied with river water by the general service pump and the bilge and ballast pump in the engine room.

2.18 Coating Protection

2.18.1 Surface Preparation

Prior to any sand/grit/wet blasting, all sea chests strainer plates will be removed and all hull openings, transducers, anodes, waster pieces, bearings, stern tube openings, fiber glass covers (over shafts and domes) and propellers will be plugged, covered, and otherwise protected from damage or contamination during surface preparation and coating application.

All steel surfaces will be prepared to near white, blasted to SA 2½ standard.

After sand/grit/wet blasting, surfaces will be brushed with clean brushes, blown off with compressed air, or cleaned by vacuum to remove all traces of blast products and dust.

The surfaces to be painted will have the specified surface preparation at the time of application of the paint. If the surface is degraded or contaminated subsequent to surface preparation and prior to painting, the surface will be restored before paint application.

In order to prevent degradation or contamination of the prepared surfaces, the first coat of paint will be applied as soon as possible after the surfaces have been prepared. The first coat will always be applied the same day as surface preparation is completed. Succeeding coats will be applied before contamination of the under surface occurs.

After surface preparation, surfaces will be brushed with clean brushes, blown off with compressed air, or cleaned by vacuum to remove all traces of blast products and dust.

Whenever sand/grit/wet blasting or spray painting is specified for surface preparation of exterior steel surfaces in places where applicable regulations and laws prohibit release of blast materials and paint into the atmosphere, the surfaces shall be enclosed in a cover adequate to contain the blast materials and paint.

Cleaning and painting will be so scheduled that detrimental amounts of dust or other contaminants do not fall on wet, newly painted surfaces.

2.18.2 Painting Schedule

1. BOTTOM & BOOT TOP AREA (COALTAR EPOXY SYSTEM)
 - a) Anti Corrosive System
 - i) Epoxy Primer 1x50 Microns
 - ii) Coaltar Epoxy 1x100 Microns
 - iii) Modified Coaltar Epoxy (Sealer Coat) 1x100 Micron
 - b) Antifouling System
 - i) Self Polishing Antifouling Paint (for 24 months protection) 2x50 Microns
2. TOP SIDES (RECOATABLE EPOXY SYSTEM)
 - a) Epoxy Primer 1x50 Microns
 - b) Recoatable Epoxy Undercoat 1x100 Microns
 - c) Recoatable Epoxy Finish 1x100 Microns
3. DECK (RECOATABLE EPOXY SYSTEM)
 - a) Epoxy Primer 1x50 Microns
 - b) Recoatable Epoxy Undercoat 1x100 Microns
 - c) Recoatable Polyurethane/ Epoxy Finish 1x100 Microns
4. BILGES/BALLAST/TANKS (COALTAR EPOXY SYSTEM)
 - a) Epoxy Primer 1x50 Microns
 - b) Coaltar Epoxy (two different shades) 2x100 Microns
5. SUPERSTRUCTURE-EXTERIOR (RECOATABLE EPOXY SYSTEM)
 - a) Epoxy Primer 1x50 Microns
 - b) Recoatable Epoxy Undercoat 1x75 Microns
 - c) Recoatable Epoxy Finish 1x35 Microns
6. SUPERSTRUCTURE-INTERIOR (RECOATABLE EPOXY SYSTEM)
 - a) Epoxy Primer 1x50 Microns
 - b) Recoatable Epoxy Undercoat 1x75 Microns
 - c) Recoatable Epoxy Finish 1x35 Microns
7. DECK FITTINGS (RECOATABLE EPOXY SYSTEM)
 - a) Epoxy Primer 1x50 Microns
 - b) Recoatable Epoxy Undercoat 1x75 Microns
 - c) Recoatable Epoxy Finish 1x35 Microns
8. MACHINERY SPACE (EPOXY SYSTEM)
 - a) Below Floor Plates
 - i) Epoxy Primer 1x35 Microns

- ii) Recoatable Epoxy Coating 1x75 Microns
- b) Above Floor Plates
 - i) Epoxy Primer 1x50 Microns
 - ii) Recoatable Epoxy Undercoat 1x75 Microns
 - iii) Recoatable Epoxy Finish 1x35 Microns

9. CHAIN LOCKER, ANCHORS, CHAINS & VOID SPACES

High Build Bituminous Paint 1x250Microns

In addition to this coating and cleaning of surfaces should be subjected to classification society requirements. All paints shall be class type approved.

2.18.3 Pipe work Coloring

All exposed piping systems will be identified with colour bands in accordance with the following colour schemes:

- | | | | |
|----|-------------------|---|-------------|
| 1) | Bilge and Ballast | : | Black |
| 2) | Firemain | : | Bright red |
| 3) | Fuel oil | : | Brownss |
| 4) | Lub oil | : | Yellow |
| 5) | Hydraulic oil | : | Purple |
| 6) | Sea suction | : | Green |
| 7) | Seawater cooling | : | Light green |
| 8) | Compressed air | : | White |

2.19 Deck Inventory

2.19.1 Anchors, Chain Cables and Ropes

- 2 - Anchor, 200 kg. each
- 2 - Chain cable, high strength, welded, 8 mm dia 45 m line
- 1 - Stream wire, F.S. WR. 6 x 24, 16mm dia, 90 m in length
- 1 - Spare anchor shackle
- 2 - Spare joining shackles
- 1 - Chain hook
- 1 - Shackle punch

2.19.2 Compass & Nautical Equipment

- 1 - Bell, 150 mm in diameter
- 1 - Compass, table mounted, 150 mm card diameter

2.19.3 Navigation Lights and other Lamps.

- 1 - Starboard side lamp, electric
- 1 - Port, side lamp, electric
- 3 - Mast head lamp, electric
- 1 - Stern lamp, electric
- 1 - Anchor lamp, electric
- 1 - Search light (200 mm dia 500 watts)

2.19.4 Signal Equipment

- 1 - Foghorn
- 3 - Black balls
- 2 - Rocket signals
- 4 - Parachute signals

2.19.5 Flags, etc.

- 1 - Bangladesh ensign
- 1 - Set-hand signal flags
- 1 - Set-International Signal flags

- 1 - International code of signal
- 2.19.6 Canvas Covers
 - 1 - each-Rigging screw cover
 - 2 - Chain pipe covers
 - 1 - Compass cover
 - 2 - Searchlight covers
- 2.19.7 Fire Fighting Appliances
 - 1 - CO₂ extinguisher - 6 kgs
 - 1 - Powder extinguisher - 7 kgs.
 - 1 - Deck-wash connection consisting of a deck valve with 1½" hose coupling and hose.
 - 2 - Nozzles of required size
 - 1 - Breathing apparatus
 - 1 - Fire axe
 - 1 - Flame safety lamp
- 2.19.8 Boatswain's & Carpenter's Stores
 - 2 - Sounding rods
 - 1 - Wooden spike
 - 1 - Steel spike
 - 2 - Chipping hammers
 - 1 - Hand hammer
 - 1 - Claw hammer
 - 1 - Chisel
 - 1 - Plane
 - 1 - Axe
 - 1 - Tinman's scissors
 - 2 - Oil stones
 - 1 - Tape measure
 - 1 - Crow bar
 - 1 - Serving board
 - 10 - Padlocks
 - 2 - Hawsers gratings
 - 2 - Rat guards
 - 1 - Serving mallet
 - 2 - Paint scrapers
 - 2 - Paint scrapers with long shafts
 - 4 - Paint brushes
 - 2 - Wire brushes
 - 1 - Oil can
 - 1 - Oil funnel
 - 1 - Oil feeder
 - 1 - Portable oil lamp
 - 1 - Portable hand bilge pump
 - 1 - Shifting spanner
 - 1 - Bottom plug spanner
 - 1 - Filling pipe spanners
 - 2 - Spanners
 - 2 - Tar brushes
 - 1 - Pincer
 - 2 - Sounding pipe spanners
 - 1 - Key box
 - 1 - Key hanger board

B-3. MACHINERY

3.1 General Description

All machinery including main and auxiliary engines, crane, pumps, equipment etc. will be of approved type and supplied with certificates as required by the classification society. All such machinery will be of reputed make, popular and well known in Bangladesh and have proven satisfactory after sales service and spare parts facilities. We shall submit a proposal to the Purchaser on the make and model of equipment. No machinery will be procured/supplied or installed without the prior written approval of the purchaser.

3.2 Main Engine

The marine quality propulsion machinery will be brand new, popular and well known in Bangladesh, which has proven after sale service facilities and readily available spare parts.

The power for propulsion will consist of one unit of marine diesel engine complete with all accessories, pumps, etc. as follows:

Make	:	Diesel Marine Engine of reputed make certified by classification society with special survey
MCR	:	To be mentioned
RPM	:	Not exceeding 1800 at MCR
Cooling System	:	Fresh water heat exchanger cooled.
Country of Origin, Country of Manufacture, Country of Assembly, Country of Shipment	:	EU Countries/ USA/ Australia/ Canada/ Japan/ UK

Main engines shall be class certified.

3.3 Propeller

The propeller will be of standard 3/4 - blade type made of manganese bronze. Propellers shall be manufactured and certified by the particular class.

3.4 Propeller Protection

At the outside of propeller, a propeller protection thrust increasing fixed nozzle will be fitted. Propeller shall be of class certified materials & design shall be class approved.

3.5 Propeller Shaft

The propeller shaft will be of Duplex Stainless Steel and covered with proper material in way of after bearing. The bearing will be of rubber cutlass. Propeller shaft shall be of class certified materials & design shall be class approved.

3.6 Stern Tube

The mild steel stern tube will be of heavy construction with a sturdy connection to the hull at the fore end and will contained forward and aft bearing bushes and stuffing gland to meet the rules of Class. Stern tube shall be of class certified materials & design shall be class approved.

3.7 Auxiliary Sets

The electric power plant will consist of one main diesel driven generator set and one harbor use diesel generator set, installed in the engine room complete with the driving unit. Capacity of the main generator will be such that it can meet the full requirement under normal navigation etc. The harbor generator set will be sufficient for necessary pump, light etc. when the vessel lies at anchor.

3.7.1 Main Generator

Number – 2 Nos.

Make - reputed make

Prime mover Make – reputed make

Alternator Make - reputed make

Power: Minimum 50KW or 45KW, 220 V AC, 50Hz, 3 Phase, 0.8Pf

Country of Origin: EU Countries/USA/Australia/Canada/Japan/UK

Marine quality Generator & engines shall be class certified as applicable.

3.7.2 Harbor Generator

Make – reputed make
Power: Minimum 5kW
220 V AC, 50Hz, 1 Ph/3 Ph, 0.8Pf
Country of Origin: EU Countries/USA/Australia/Canada/Japan/UK
Harbor Generator shall be class type approved as applicable.

3.8 Steering Gear

One manual hydraulic system, as described in section 2.15.4, will be provided with steering stand in wheelhouse. In case of failure of the system, alternative (Manual steering) arrangement will be provided. Steering gear system shall be class approved as applicable.

3.9 Bilge/Ballast/Fire Pump

One bilge pump driven by engines will be supplied. **All the pumps should be installed as per classification society requirements.**

Bilge/Ballast/Fire Pump Capacity: about 25m³/hour

Make - reputed make
Motor - 0.75 kW
Country of Origin: EU Countries/ USA/Australia/Canada/Japan/UK

3.10 General Service/Fire Pump

One (1) horizontal self-priming centrifugal pump will be supplied.

General Service/ Fire Pump Capacity: about 25m³/hour
Make - reputed make

Motor - 0.75 kW

3.11 Fuel Oil Transfer Pump

2 Nos. Fuel Oil Transfer pump and 2 Nos. hand operated pump shall be provided.

Fuel Oil Transfer Pump Capacity: about 3 m³/hour
Make - reputed make
Country of Origin: EU Countries/ USA/Australia/Canada/Japan/UK

3.12 Fresh Water Pump

One Fresh Water pump shall be provided.
Fuel Oil Transfer Pump Capacity: about 3 m³/hour
Make - reputed make
Country of Origin: EU Countries/ USA/Australia/Canada/Japan/UK

3.13 Sewerage Pump

One Sewerage pump shall be provided.
Sewerage Pump Capacity: about 5 m³/hour
Make - reputed make
Country of Origin: EU Countries/ USA/Australia/Canada/Japan/UK

3.14 Emergency Fire Pump

One Emergency fire which is engine driven shall be provided.
Sewerage Pump Capacity: about 5 m³/hour
Make - reputed make

Country of Origin: EU Countries/ USA/Australia/Canada/Japan/UK

All the above mentioned pumps should be installed as per classification society requirements and approval.

3.15 Engine Room Ventilation

For adequate natural ventilation of the engine room one ventilation cowl will be provided.

3.16 Engine Exhaust

Insulated exhaust pipes with silencers will be provided as required for end exhaust.

3.17 Control and Alarms

The main engine revolutions and gearbox operation will be mechanically remote controlled from the wheelhouse. An instrument panel will be fitted in the wheelhouse dashboard, complete with stopping button and starting key, optical and acoustical alarms, meters etc.

The alarm system will consist of a separate control light for each alarm and combined electrical horn will be provided for the engine:

- Temperature of cooling water
- Main engine oil pressure
- Gear oil pressure (only control lamp)

A push button will be fitted to reset the alarm horn.

Following gauges will be provided for main and auxiliary engines:

- Oil pressure
- RPM
- Cooling water temperature.

3.18 Cooling System

The main engine will be cooled by its own closed fresh water-cooling circuit.

B-4. ELECTRICAL INSTALLATION

4.1 General

Only good quality marine fittings shall be supplied and fitted.

Complete electrical system is to be designed and installed in accordance with classification society and other rules and regulations concerned.

Everything necessary for the working of the electrical system whether specially mentioned or not, is to be supplied and fitted to the satisfaction of the Classification Society.

4.2 Installation Standard

These are to the rules and regulations of the Classification Society for the class and type of vessel specified.

4.3 Cables:

All cables employed for the vessel shall comply with the requirements of the classification society rules. In general, all cables are to be ERP insulated, PVC sheathed and steel wire braided marine cables.

In general, cables are to be arranged and laid in a neat manner adequately supported on cable trays supported by galvanized steel hanger and fitted with supporting clips.

Where cables are exposed to weather, they are to be protected by steel pipe (SGP).

4.4 Power Sources:

- a) AC Power

Two in number as detailed in machinery specification.

b) DC Power for starting, lighting and emergency

Two (2) batteries with 12 V, 200 Ah. each, shall be installed in lead plate lined steel box. The battery shall be secured and placed on a wooden platform. On the engine a 40 Amp. 24 V alternator shall be mounted to charge the battery. The batteries to be used for electrical starting of the engine and supplying for lighting and other electrical equipment.

4.5 Switchboard

The switchboard shall be placed in the wheel house, with double pole, molded case type circuit breakers or fuse with switch for the following group:

- Navigation lights
- Second top light
- Search light
- Whistle
- Wipers
- Clear view screen
- Main engine and instruments

A time switch shall be fitted in the switchboard for the engine room lighting. Meters shall be provided for voltage and charging/discharging of the battery. **Main Switch board shall be class certified.**

4.6 Shore connection 440 V:

A wall plug with 20m cables, connected to a fuse box with 440V plug socket.

4.7 Lighting

a) Engine room

5 bullseyes 20W each with time switch in wheel house on switchboard.

b) Wheelhouse

One ceiling light 20W with diffuser for variable illumination. One 8 W light to facilitate further lighting for all time operation.

c) Main deck

Waterproof deck lights of 60W at the aft and fore side of the wheelhouse or near the steering position as is required.

d) Navigation Lights

- 1 No. Starboard lamp
- 1 No. Port lamp
- 1 No. Stern lamp
- 1 No. Anchor lamp
- 1 No. Masthead lamp

Make - reputed make

e) Deck flood Lights

Flood lights will be of 300 W capacity each. Two will be fitted onboard.

Make - reputed make

Country of origin of all electrical lights including navigation lights - EU countries/USA/UK /Australia/Canada/Japan/ Malaysia.

4.9 Nautical Equipment

a) Signaling Lamp

A morse lamp will be fitted on main mast trunk and operating key on steering console.

b) Search light

A 20 cm 500 watt. searchlight will be fitted on top of wheelhouse with provision for movement up and down as well as all-round with control arrangement located conveniently on the right of the wheel. One set of spare bulbs will be supplied.

All the navigation lights shall be class type approved.

Make - reputed make

c) Whistle/Horns

On the wheelhouse top a horn will be fitted fed from A/C power system, control in the steering wheel as described in sec 2.15.11.

Country of origin of all nautical equipment- EU countries/USA/UK/Australia/Canada/Japan

5. Clear view Screen

One standard clear view screen will be fitted in one of the front windows of the wheelhouse.

B-5. TOOLS

With the vessel complete with engine, equipment, tools, accessories and tools and on board spare parts will be provided & supplied. List is provided hereunder.

5.1 TOOLS for each crane boat

Description	Qty.
Deck	
Wire brush	6
Cable punch	2
Cold chisel 150mm	1
Cold chisel 220 mm	1
Grease Gun	1
12" Hacksaw c/w 12 spare blades	1
Chipping hammer with shaft	6
1 lb Claw hammer with shaft	1
2 lbs hand hammer with shaft	1
7 lbs sledge hammer with shaft	1
Screw driver 300 mm	3
- 200 mm	3
- 150 mm	3
Galvanized shackles	
- 1-ton S.W.L. (harp)	2
- 2-ton S.W.L. (harp)	2
- 1/4-ton S.W.L. (harp)	2
- 1-ton S.W.L. (harp)	2
Spanner- 300 adjustable	1
Sounding tape	1

Description	Qty.
Deck	
Engine Room	
"Allen" key	
Chain Block - 1 ton S.W.L	1 roll
Double sheaves - 1/2-ton S.W.L.	1
Wire brush	6
Electric drill - portable	1
Electric grinder - heavy duty	1
Grease gun	1
Feelers	1 set
Files 6 assorted with handles	1 set
Hacksaw 12" c/w 12 blades	2
Hammer - Chipping with shaft	3
- 2 lbs hand with shaft	2
- 7 lbs hand with shaft	1
Slide calipers - 200 mm	1
Punches (11, 14, 18, 21 mm)	4 each
Plier - inculcate type	1 pair
- ordinary	1 pair
Punches – assorted	1 set
Scissors - 8"	1 pair
Scrapers - 3 assorted bearing	1 set
- 3 paint	1 set
Screw driver - three assorted	1 set
Sounding tape	2 nos.
Thermometer	2 nos.
Vice - 150 mm	4
Work bench – steel	1
Clock	1
Tool box, steel	1
Socket box wrench	24 pcs
Double end open spanner	16 Nos. (from 3/8 to 1 ^{1/2})
Double end ring spanner	16 Nos. (from 3/8 to 1 ^{1/2})

All tools must be EU countries/USA/Australia/Canada/Japan/UK origin.

B-6. Accommodation

Accommodation space for 2 crews shall be made on the main deck. There will be a toilet and necessary supplies and equipment for the toilet. There will be space for kitchen, galley, and two single beds. Accommodation space will have a manhole through which engine room will be accessible. There will also be a manhole from which navigation deck will be accessible from the accommodation space. All necessary equipment for the accommodation space will have to be provided. All the sanitary fittings should be of USA/Canada/Japan/EU countries/ Australia/ UK/ Malaysia/ Indonesia/ Korea Origin.

B-7. Communication Equipment

All navigational equipment shall be of class type approved.

7.1 Navigational Echo Sounder:

The equipment shall be new, unused, high quality and current commercial design & technique. It shall be made of components that will be supported by vendors at least ten years. The equipment and materials shall be suitable for operation under the environmental condition of Bangladesh. The equipment shall be maintainable in the field to the lowest replaceable unit by local personnel. The equipment must be light weight, robust, accurate and in waterproof enclosure and corrosive resistance. All parts and accessories of the equipment shall be free from manufacturing and/or material defect such as breaks, cracks, dents, deformation etc. when delivered at the place of destination. The equipment shall be fitted with the vessels. The transducer shall be hull mounted & provided in a watertight compartment in the bottom.

Labeling:

For equipment and all major components nameplates from original component manufacturer shall be attached and nameplates shall bear mode, serial numbers, year and place of manufacture, safety warnings and any other information critical to the component.

Codes and Regulations:

The equipment shall comply with the international standards, codes and regulations.

Tests and Acceptance:

The supplier shall arrange transportation for inspection and tests of the equipment/Goods. Tests will be taken in the field (river) around Narayangonj/Chandpur/Aricha. Supplier will, at his cost, assemble/install the equipment and demonstrate their operation. On successful completion of the tests, the Purchaser will issue acceptance certificate.

Maintenance Manuals:

One complete set of maintenance, installation and operation manuals shall be provided for each of equipment. The manuals should have detail and comprehensive circuit diagrams as are required to diagnose and rectify faults. Photographs block schematic circuits and other diagrams shall adequately illustrate the text of each manual. The manuals must be in English language. The maintenance manuals should be adequate for skilled technicians to fully test and repair the equipment by replacing any parts therein.

Technical Specifications of Navigational Echo-sounder/Digital Depth Sounder:

Name of Item or Related Service	:	Technical Specification
Model	:	2019
Country of Origin	:	EU Countries/USA/ Australia/ Canada/Japan/UK
Type	:	Navigational Echo-sounder/Digital Depth Sounder
Unit	:	Feet or Meter
Depth Range	:	0.5-100 Meter
Accuracy	:	<2%
Frequency	:	210/200/50 KHz
Power	:	12VDC \pm 2VDC
Display	:	LCD Display (LCD Digits at least 1")

Transducer	:	Hull mounted type 210/200/50 KHz
Transducer Cable	:	20 Meter
Operating Temperature	:	0 to 50°C
Adjustable keel offset	:	±2.5m
Adjustable keel offset	:	±0 to 5m adjustable at 1 cm steps
Accessories	:	Power cable, Interfacing cable, Operation & Maintenance manual.

7.2 GPS receiver:

All equipment shall be latest design & technique, high quality, new and unused.

The Goods shall comply with following Technical specifications:

Item No	Name of Item or Related Service	Technical Specification and Standards
1	2	3
	DGPS Receiver	a. C/A code, L1 1575 MHz measurement.
	Model	2019
	Update rate	At least 10 Hz
	Accuracy	1-5m 2DRMS Position with DGPS + 0.05M/s Velocity with DGPS.
	DGPS Beacon Receiver	
	Type	Automatic or Manual tuning.
	Frequency	283.5-325.0 KHz in 500 Hz steps
	Interface	2 bi-directional USB/RS ports (db9 female port with 5m cable)
	Display	
	LCD	High resolution LCD display.
	DGPS Status Display	(i) Tracking station frequency, ID, and Distance (ii) Baud rate, Noise and Signal strength. (iii) Satellite Number (PRN), respective correction and correction age.
	Position reference system	Lat/Lon.
	Country of Origin	USA/CANADA/JAPAN/EU Countries/ Australia/UK
	Antennas:	
	Type	Antenna type, quantity, dimension etc. to be mentioned clearly in the offer. The antenna must be a combined GPS and beacon.
	Cable length	30 meters (100ft)
	Environmental:	
	Operating temperature	0 to 50°C.
	Power:	
	Supply Voltage	11-30 VDC with polarity protection

Registration & Survey of Crane Boats (with Directorate of Shipping /Mercantile Marine Department of Bangladesh) must be completed by supplier's own cost.

8. The lights of all vessels shall be LED (Marine Quality) with 5 (five) years warranty except search light and signal light. Country of LED lights shall be EU Countries/USA/Australia/Canada/Japan/UK.

9. The generator below 10KW shall be of single phase and above 10KW shall be three of phase. The Voltage of single phase and three phase generator shall be 220V & 400 V respectively.

10. The supplier must notify to the classification society before opening of Letter of credit (LC) for procurement of those items/equipment which are needed classification society approval/certification.

C. HDPE Shore Pipe for 28" cutter suction dredger

High Density Poly Ethylene (HDPE) floating pipes of proven design and reputed make. Each pipe is to be of approximately 6 meter in length with flanges at both ends. It should be replaceable with shore pipe sections.

Length each with flanges (approx.)	:	6.0 meter
Inner diameter (approx.)	:	700 mm
Thickness (minimum)	:	45 mm
Materials	:	Virgin PE-100 , HDPE (High Density Poly Ethylene)
Pressure capacity (minimum)	:	10 bar
Accessories	:	Elbow, bolts, nuts and rubber gaskets etc.
Country of Origin	:	EU Countries/ UK/USA/ Australia / New Zealand/ Canada/ Japan/ South Korea/ Bangladesh
Quantity	:	5000 meter

D. HDPE Floating pipe with foam type floater for 28" cutter suction dredger

High Density Poly Ethylene (HDPE) floating pipes of proven design and reputed make. Each pipe is to be of approximately 6 meter in length with flanges at both ends. It should be replaceable with shore pipe sections.

Length each with flanges (approx.)	:	6.0 meter
Inner diameter (approx.)	:	700 mm
Thickness (minimum)	:	45 mm
Materials	:	Virgin PE-100 , HDPE (High Density Poly Ethylene)
Pressure capacity (minimum)	:	10 bar
Accessories	:	Elbow, bolts, nuts and gaskets etc. to be supplied
Country of Origin	:	EU Countries/ UK/ USA/ Australia/ New Zealand/ Canada/ Japan/ South Korea/ Bangladesh
Quantity	:	3000 meter

E. Foam Type Floater for 28" cutter suction dredger

Inner Diameter	:	Inner diameter of floater shall be derived from the outer diameter of HDPE floating pipe.
----------------	---	---

Outer Diameter	:	The Outer diameter of the floater shall be designed by manufacturer in such a way so that the floating pipe shall float about 35 (thirty-five) percent above water during dredging operation.
Material		Medium density polyethylene (MDPE) foam type floater
Accessories		Bolts, Nuts and Spacers etc. to be supplied
Length (minimum)	:	1500 mm each
Quantity	:	1000 Nos (each floater consists of two half circle)
Total length (minimum)	:	1500mm x 1000 Nos = 1500000 mm
Country of Origin	:	EU Countries/ UK/ USA/ Australia/ New Zealand/ Canada/ Japan/ South Korea/ Bangladesh

In addition to the above the following conditions shall be fulfilled by the supplier. For High Density Poly Ethylene (HDPE) shore pipes, Floating pipes, Foam Type Floater as specified in section C, D & E of tender document, the following terms & conditions shall be applied.

- i. The supplier shall provide following test certificates during delivery from Bangladesh University of Engineering & Technology (BUET) or any other competent authority approved by BIWTA/Consultant for the above-mentioned items
 - a. Pressure test
 - b. Bursting pressure test.
 - c. Stress test
 - d. Elongation test.
- ii. High Density Poly Ethylene (HDPE) shore pipes, High Density Poly Ethylene (HDPE) floating pipes, Foam Type Floater to be produced as USA/CANADA/JAPAN/EU Countries/Australia/New Zealand/South Korea/ UK standard.
- iii. Virgin raw Material shall be used for making the High Density Poly Ethylene (HDPE) shore pipes, High Density Poly Ethylene (HDPE) floating pipes, Foam Type Floater. If any recycled material mixed with virgin material is found, product shall be stand rejected.
- iv. Virgin raw materials used in HDPE pipe production must be PE 100.
- v. PE 100 Virgin raw material to be imported from USA/CANADA/JAPAN/EU Countries/Australia/New Zealand/UK/Saudi Arabia/ Taiwan/ South Korea.

F. Ball Socket for 28" Cutter Suction Dredger

1.1 Introduction:

These specifications describe the requirements for the ball joints which shall be provided by the supplier in good condition.

1.2 Workmanship:

The ball joints shall be delivered to the purchaser in new condition, clean and free of all debris and shall be manufactured of new materials and components. Special measures shall be taken to prevent wear, damage or deterioration before delivery. Materials and workmanship involved in the construction of the ball joints shall be of a quality confirming to good commercial/marine practice.

1.3 Standard

The ball joints shall be new, suitable for heavy duty marine application, of recent manufacture, free from defects and imperfections, and be products of good commercial grade materials that are currently produced by reputable manufacturers. Materials are used shall be suitable for the purpose intended.

1.4 Dimensions: As per standard (**28" Cutter Suction Dredger**)

1.5 Country of Origin: EU Countries/USA/ Australia/ Canada/Japan/UK/Turkey/ South Korea origin

1.6 Standards

The ball joint should conform to approved standards for similar equipments. The supplier shall obtain a certificate from manufacturer confirming the standards maintained in respect of materials and workmanship for construction of the ball joints and furnish this certificate along with the supply.

1.7 Marking

Each ball joint must have the following identification marks in non-corrosive marine paint near the two ends and punched on the rim of the flanges with letter punches:

BIWTA

1.8 The male and female parts of all ball joints have to be interchangeable.

1.9 Each ball joint shall be completed with seals/packing.

1.10 Drawings

Relevant drawings are to be provided for ball socket.

G. Rubber Hose Pipe for 28" Dredger

1.1 Introduction

These specifications describe the requirements for the Rubber Hose Pipe, which shall be provided by the Supplier in good conditions. Rubber Hose Pipes fitted with M. S adapter at each end of rubber hose pipe.

1.2 Workmanship

The Rubber Hose Pipe shall be delivered to the Purchaser in new condition, clean and free of all debris and shall be manufactured of new **virgin materials** and components. Special measures shall be taken to prevent wear, damage or deterioration before delivery. Materials and workmanship involved in the manufacturing of the hose shall be of a quality conforming to good commercial/marine practice.

1.3 Standard Parts

All articles, fittings and suppliers used in the manufacturing of the rubber hose pipe shall be new, suitable for heavy duty marine application, of recent manufacture, free from defects and imperfections, and be products of good commercial graded materials that are currently produced by reputable manufactures. Materials not specifically mentioned herein but are used shall be suitable for the purpose intended.

1.4 Standard

The Rubber Hose Pipe should conform to approved standards for similar equipment. The supplier shall obtain a certificate from reputed manufacturer conform the standards maintained in respect of materials and workmanship for manufacturing of the hosed and furnish this certificate along with the supply.

1.6 Materials and Measurement

Material: Best quality **virgin rubber material** to withstand high pressure and reinforced with minimum 4 layer of Polyester net.

Measurements :

Total length with flanges= $2000\pm 2\%$ mm
Total wall thickness (approx.) - 50mm
Flange outer diameter – To be mentioned
Flange thickness (approx) - 30 ± 2 mm
Hole – 24 Nos
Hole diameter – To be mentioned
Working pressure-20 bars
Test pressure- 30 bars
Bursting pressure-60 bars
Bending angle- 45° (under pressure)

1.7 Inspections and Test

Inspection and Test Certificates to be issued by the manufacturer or approved agency, certifying that the rubber hoses have been manufactured as per specification.

1.8 Drawings

Relevant drawings are to be provided for Rubber Hose pipes.

1.9 Country of Origin: EU Countries/USA/ Australia/ Canada/Japan/UK/South Korea/China origin

1.10 Hose Adapter as required quantity

1.11 Hose Clamp as required quantity.

H. List of Spare Parts for 28" (700 mm) 2 Nos. Cutter Suction Dredgers.

MAIN ENGINE

Sl. No.	Description	Required Quantity	Unit Price	Total Price
1	Cylinder liner with seal	1 set (1 set=1 Nos. x No. of Cylinder)		
2	Piston ring	2 sets (1 set=1 ring group x No. of Cylinder)		
3	Exhaust valve	2 sets (1 set=2 Nos. x No. of Cylinder)		
4	Inlet valve	2 sets (1 set=2 Nos. x No. of Cylinder)		
5	Insert (valve seat) Exhaust	2 sets (1 set=2 Nos. x No. of Cylinder)		
6	Insert (valve seat) inlet	2 sets (1 set=2 Nos. x No. of Cylinder)		
7	Valve guide Exhaust	2 set (1 set=2 Nos. x No. of Cylinder)		
8	Valve guide Inlet	2 set (1 set=2 Nos. x No. of Cylinder)		
9	Valve Spring	1 set		
10	(a) Crank Shaft bearing (Main bearing)- std	1 set (1 set=1 pair x No. of Cylinder)		
	(b) 1 st under bearing for crank shaft	1 set (1 set=1 pair x No. of Cylinder)		
11	(a) Cont. rod bearing (Big-end-bearing)- std	1 set (1 set=1 pair x No. of Cylinder)		
	(b) 1 st under bearing for cont. rod	1 set (1 set=1 pair x No. of Cylinder)		
12	Piston	1 set (1 set=1 No.x No. of Cylinder)		
13	Injector Complete	2 sets (1 set=1 No.x No. of Cylinder)		
14	Plate thrust (Thrust bearing)	2 sets (1 set=1 pair)		
15	Piston Pin (Gudgeon Pin)	2 sets (1 set=1 No.x No. of Cylinder)		
16	Complete engine overhauling gasket Kit	2 sets (1set=2 Nos. for complete engine)		
17	Lub oil filter	30 nos.		
18	Primary filter/water separator	30 nos.		
19	Secondary filter	30 nos.		
20	Air Filter	30 nos.		
21	Temperature Control Valve	2 Nos.		
22	Turbo Charger repair Kit	2 Nos.		
23	R.P.M. Sensor	2 Nos.		
24	Connecting Rod	1 set (1 set=1 No.x No. of Cylinder)		
25	Injector Harness (if any)	1 set (1 set=1 No.x No. of Cylinder)		
26	After Cooler	1 No.		
27	Atmospheric Air Pressure Sensor	1 No.		
28	Lub oil cooler	1 No.		
29	Gear Oil Cooler	1 No.		
30	Governor kit	1 set		

****If any items are not required for offered engine then equivalent spares shall be provided.***

AUXILLIARY ENGINE

Sl. No.	Description	Required Quantity	Unit Price	Total Price
1	Cylinder liner with seal	1 set (1 set=1 No.x No. of Cylinder)		
2	(a) Crank shaft bearing (main bearing) Std.	1 set (1 set=1 pair x No. of Cylinder)		
	(b) 1 st under bearing for Crank shaft	1 set (1 set=1 pair x No. of Cylinder)		
3	(a) Cont. rod bearing (Big-end-bearing)	1 set (1 set=1 pair x No. of Cylinder)		
	(b) 1 st under bearing for Cont. rod	1 set (1 set=1 pair x No. of Cylinder)		
4	Piston ring	1 set (1 set=1ring group x No. of Cylinder)		
5	Piston	1 set (1 set=1 No.x No. of Cylinder)		
6	Piston Pin (Gudgeon pin)	1 set (1 set=1 No.x No. of Cylinder)		
7	Thrust bearing	1 set (1 set=1 pair)		
8	Exhaust valve	1 set (1 set=2 Nos. x No. of Cylinder)		
9	Inlet valve	1 set (1 set=2 Nos. x No. of Cylinder)		
10	Insert (valve seat) Exhaust	1 set (1 set=2 Nos. x No. of Cylinder)		
11	Insert (valve seat) Inlet	1 set (1 set=2 Nos. x No. of Cylinder)		
12	Valve guide Exhaust	1 set (1 set=2 Nos. x No. of Cylinder)		
13	Valve guide Inlet	1 set (1 set=2 Nos. x No. of Cylinder)		
14	Injector Complete	1 set (1 set=1 No.x No. of Cylinder)		
15	Complete engine overhauling gasket Kit	1 set (1set=2 Nos. for complete engine)		
16	Lub oil filter	30 nos.		
17	Primary filter/water separator	30 nos.		
18	Secondary filter	30 nos.		
19	Air Filter	30 nos.		
20	Temperature Control Valve/Thermostat	4 Nos.		
21	Turbo Charger repair Kit	1 No.		
22	R.P.M. Sensor	1 No.		
23	Connecting Rod	1 set (1 set=1 No.x No. of Cylinder)		
24	Injector Harness (if any)	1 set (1 set=1 No.x No. of Cylinder)		
25	After Cooler	1 No.		
26	Atmospheric Air Pressure Sensor	1 No.		
27	Lub oil cooler	1 No.		
28	Gear Oil Cooler	1 No.		

Sl. No.	Description	Required Quantity	Unit Price	Total Price
29	Governor kit	1 set		

**If any items are not required for offered engine then equivalent spares shall be provided.*

GENERATOR ENGINE

Sl. No.	Description	Required Quantity	Unit Price	Total Price
1	Cylinder liner with seal	1 set (1 set=1 No.x No. of Cylinder)		
2	Piston ring	1 set (1 set=1ring group x No. of Cylinder)		
3	Piston Pin (Gudgeon pin)	1 set (1 set=1 No.x No. of Cylinder)		
4	Valve spring	1 sets		
5	Main bearing	1 set (1 set=1 pair x No. of Cylinder)		
6	Big-end-bearing	1 set (1 set=1 pair x No. of Cylinder)		
7	Injector Complete	1 set (1 set=1 No.x No. of Cylinder)		
8	Lub oil filter	10 Nos		
9	Primary filter/water separator	10 Nos		
10	Secondary filter	10 Nos		
11	Air filter	10 Nos		

**If any items are not required for offered engine then equivalent spares shall be provided.*

DREDGE PUMP ASSY. & OTHER ACCESSORIES

Sl. No.	Description	Required Quantity	Unit Price	Total Price
1	Impeller	1 no		
2	Pressure plate suction side	1 no		
3	Pressure plate engine side	1 no		
4	Impeller sleeve	1 no		
5	Cutter blades/cutter teeth with lock	10 sets (1 set means total number of blades/teeth for one complete cutter)		
6	Cutter Shaft cutless bush/bearing	1 no		
7	Cutter shaft driving motor	1 no		
8	Suction hose	2 nos.		

**If any items are not required for offered engine then equivalent spares shall be provided.*

HYDRAULIC SYSTEM AND LADDER ASSLY.

Sl. No.	Description	Required Quantity	Unit Price
1	Hydraulic pump/hydraulic driving motor for ladder/spud & cutter/ winch	4 nos.	
2	Pressure Gauge/meter	2 Nos.	
3	Relay (different sizes)	24 Nos.	
4	Electrical fuse (Various Range)	12 Nos.	
5	Magnetic Contractor	6 Nos.	
6	Hydraulic System directional Valve (single unit /double unit)	6 Nos.	
7	PLC Module	6 Nos.	
8	Flow control valve	2 Nos.	
9	Solenoid valve	2 Nos.	
10	Different types of relief valve	2 Nos.	
11	Hydraulic filter	2 Nos.	

****If any items are not required for offered engine then equivalent spares shall be provided.***

I. List of SPARE PARTS for 2 Nos. Crane Boat for 28" Dredgers.**Main engine:**

Sl. No.	Description	Required Quantity	Unit Price	Total Price
1	Cylinder liner with seal	1 set (1 set=1 No.x No. of Cylinder)		
2	Piston pin	1 set (1 set=1 No.x No. of Cylinder)		
3	Piston rings	2 sets (1 set=1ring group x No. of Cylinder)		
4	Main Bearing	2 sets (1 set=1 pair x No. of Cylinder)		
5	Big-end-bearing	2 sets (1 set=1 pair x No. of Cylinder)		
6	Thrust bearing	2 sets (1 set=1 pair)		
7	Valve spring	1 set		
8	Valve guide exhaust	1 set (1 set=2 Nos. x No. of Cylinder)		
9	Valve guide inlet	1 set (1 set=2 Nos. x No. of Cylinder)		
10	Injector complete	1 set (1 set=1 No.x No. of Cylinder)		
11	Complete engine overhauling gasket Kit	2 sets (2 Nos. for complete engine)		
12	Lub. oil filter	30 Nos		
13	Fuel oil filter	30 Nos		
14	Air filter	30 Nos		
15	Lub oil cooler	1 No.		
16	Morse Cable	2 nos.		

17	Remote Control box	1 No.		
19	Propeller shaft bush	2 sets		
20	Propeller	1 No.		
21	Seal for Ram/Boom (different sizes)	8 sets		
22	Pressure Gauge	2 Nos.		
23	All kinds of electrical valve	2 sets		

****If any items are not required for offered engine then equivalent spares shall be provided.***

Note1: If there is anything missing in the technical specification (Annex-I) or anything in its list of supply towards sound & safe construction as per shipbuilding standard/practice shall be supplied at the supplier's own cost.

Note 2: All the part no. of spare parts shall be mentioned at the time of delivery.

Note 3: All spare parts shall be supplied from original manufacturer.

J. FS Wire rope

For Side Winch: 20 Coils (each coil 300 meters)- size minimum 36 mm

For Ladder: 20 Coils (each coil 300 meters)- size minimum 36 mm

For dredger spud: 20 Coils (each coil 300 meters)- size minimum 36 mm

For dredger Towing: 20 Coils (each coil 300 meters)- size minimum 28 mm

Anchoring for floating pipe at discharge line: 20 Coils (each coil 300 meters)- size 20 mm

Specification:

Construction of the Rope: 6 X 19 (12+6+1) FC

Normal Tensile Strength: 1670-1770 N/sq.mm

Lay of Wire: Right Hand Regular Lay

Minimum Breaking Strength for 20 mm: 220-234 kN

Minimum Breaking Strength for 28 mm: 432-458 kN

Minimum Breaking Strength for 36 mm: 714-757 kN

Length per coil: 300 meter

Grade: A (Galvanized)

Country of Origin: EU Countries/USA/ Australia/ Canada/Japan/UK/Korea/China

Responsibility of Classification Society

The appointed Classification society will discharge services & perform the following responsibilities as per rules and regulation of classification Society:

1. Examine the design & drawing for Hull & Machinery Class for Dredgers and Crane boat.
2. Provide design approval service & the drawing/design must be reviewed as many times as needed.
3. Check stability & conduct inclining experiment and other calculations.
4. Conduct construction supervision.
5. To review specification, quality of works, origin off all materials, equipment, systems, appliances, supplies, required to construct vessel.
6. Supervision and monitoring of construction of the dredger and crane boat along with accessories from commencement date until completion. To check detail specifications, standard origin of all machineries to be installed on board including main, auxiliary engine, dredge pump, hydraulic system etc.
7. To check detail specifications, standard origin of all equipment including dock equipment, engine room equipment, bridge equipment, Navigation equipment, firefighting equipment, galley equipment.
8. To check detail description of all type of systems including steering system, electrical system, control system, cooling system, fire-fighting system, bilge-ballast system, fresh & seas water system, ventilation system, fuel-oil system, exhaust system.
9. To check all type of appliances including electrical appliances, life- saving appliances and accommodation appliances, communication equipment & maintenance tools.
10. Classification society surveyor will attend during inclining experiment, load line survey, test-trial & other experiments in order to ensure quality & performance.
11. Provide Hull and Machinery Certificate as per class rules, Load Line Certification, Safety Construction, intact stability, Damage Stability, Tonnage, cargo gear/lifting gear Certificate whichever applicable and other documents/certificates required to register under DOS as Inland Water Way (I.W.W) vessel.
12. Conduct Specification survey as per Purchaser Contract Agreement.
13. To ensure Quality and specification for the equipment installed on the vessels.
14. To ensure quality of materials used for construction.
15. To be present during each survey/inspection of Purchaser representative.
16. To monitor the launching of the vessels following standard launching procedure and to carry out tests, trials & supervision of vessels.
17. To conduct test trail and to complete acceptance procedure on behalf of BIWTA.
18. Submission of progress report regularly.
19. To assist the purchaser to accept the dredger, crane boat & other accessories like pipe, floater, ball socket, rubber hose, FS wire rope, spare parts etc as per contract agreement.
20. To provide certificates at different payment stages as per GCC clause 27.1 of the tender document.
21. Any other services as required.
22. Finally, The vessel shall be classed by the classification society & issue class certificate for the vessel to the purchaser.

FOR GUIDE LINE ONLY

PRINCIPAL PARTICULARS

LENGTH LOA (About) : 60.00M

BREADTH MLD (About) : 13.50M

DEPTH MLD (About) : 3.20M

DRAUGHT LOADED (max.) : 2.00M

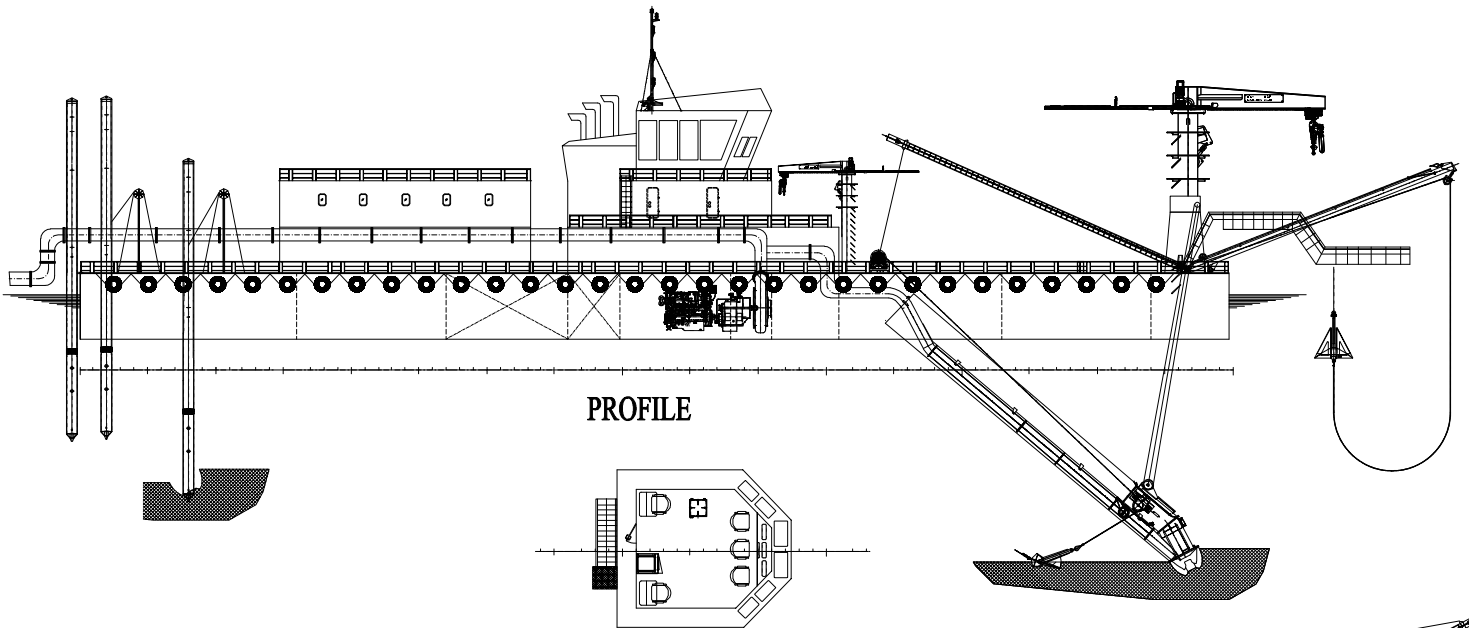

PROFILE

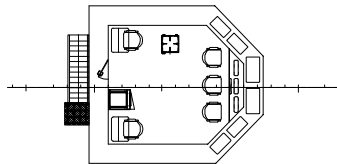

NAVIGATION DECK

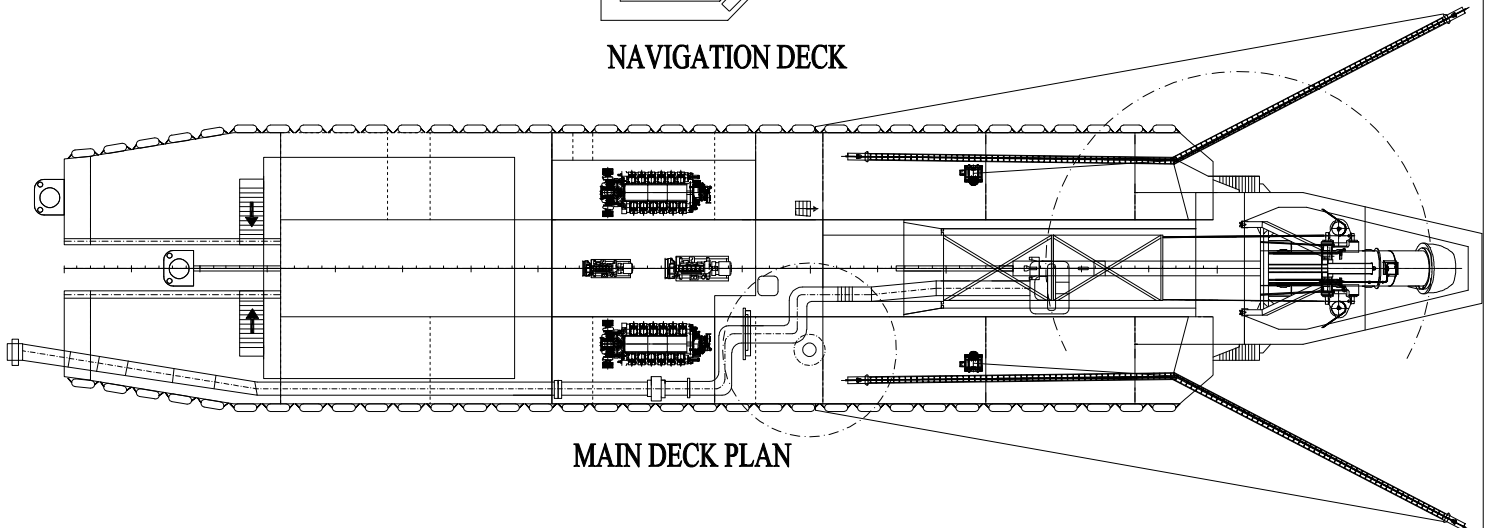

MAIN DECK PLAN

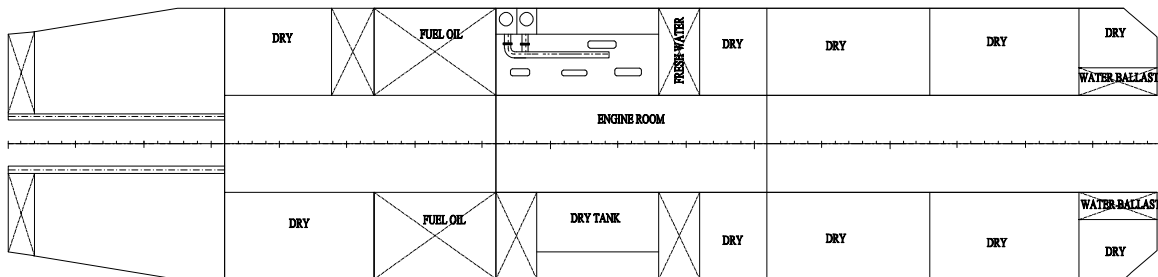

BOTTOM PLAN

GENERAL ARRANGEMENT PLAN
28" CUTTER SUCTION DREDGER
B. I. W. T. A.

PROJECT Procurement of 35 nos Dredger with other ancillary Vessel & accessories and required infrastructure development

DRAWN BY:

DATE :

SCALE : NOT IN SCALE

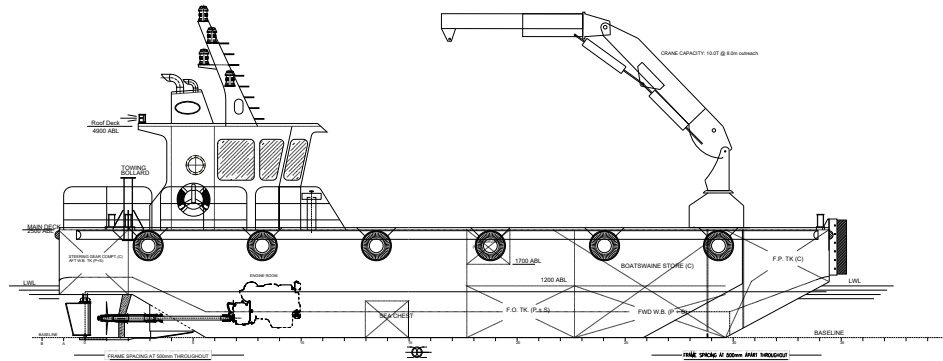

OUTBOARD PROFILE

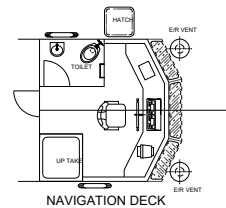

NAVIGATION DECK

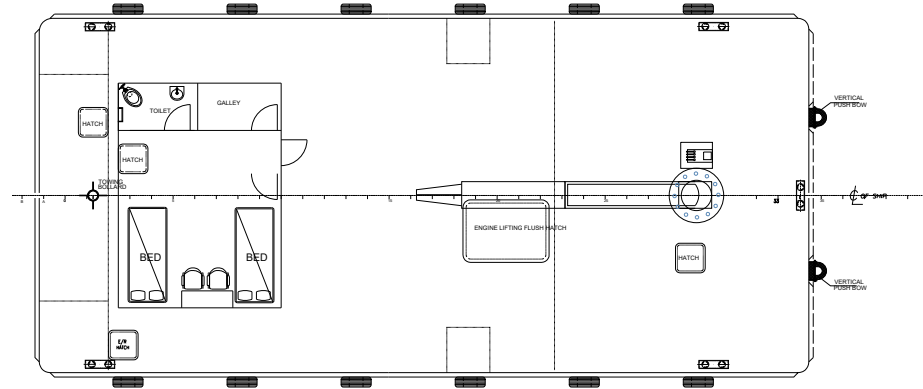

MAIN DECK PLAN

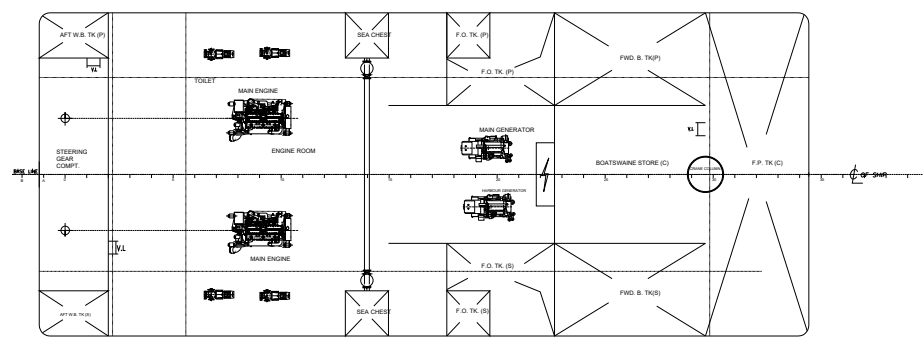

BELOW MAIN DECK PLAN

PRINCIPAL PARTICULARS

LENGTH OVERALL(about)	20.00 M
BREADTH MLD.(about)	8.00 M
DEPTH MLD.(about)	2.50 M
LOADED DRAFT (AMIDSHIP)(maximum)	1.20 M
CRANE CAPACITY(about)	10.0 T @ 8M outreach

Folding Knuckle Boom Telescopic Crane
10 Tons @ 8m outreach

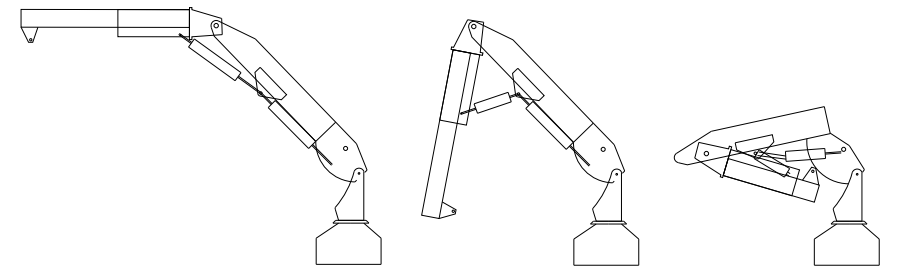

Crane Side View

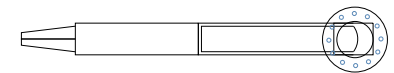

Crane Top View

**GENERAL ARRANGEMENT PLAN
Crane Boat for 28 inch Dredger
B. I. W. T. A.**

PROJECT	Procurement of 35 nos Dredger with other ancillary Vessel & accessories and required infrastructure development	
DRAWN BY:		
DATE :		